

## Excellent Integrated System Limited

Stocking Distributor

Click to view price, real time Inventory, Delivery & Lifecycle Information:

[STMicroelectronics](#)  
[ESDAVLC8-1BT2Y](#)

For any questions, you can email us directly:

[sales@integrated-circuit.com](mailto:sales@integrated-circuit.com)



# ESDAVLC8-1BT2Y

## Automotive single-line low capacitance Transil™, transient surge voltage suppressor (TVS) for ESD protection

Datasheet – production data



### Applications

Where transient overvoltage protection in ESD sensitive equipment is required, such as:

- Automotive applications
- Computers
- Printers
- Communication systems
- Cellular phone handsets and accessories
- Video equipment

### Features

- Single-line bidirectional protection
- Breakdown voltage = 8.5 V min.
- Very low capacitance = 4.5 pF at 0 V
- Lead-free packages
- ECOPACK®2 compliant component
- AEC-Q101 qualified

### Benefits

- Very low capacitance for optimized data integrity
- Very low reverse current < 50 nA
- Low PCB space consumption: 0.6 mm<sup>2</sup>
- High reliability offered by monolithic integration

### Complies with the following standards:

- IEC 61000-4-2 (exceeds level 4)
  - 17 kV (air discharge)
  - 17 kV (contact discharge)
- ISO10605: C = 330 pF, R = 330 Ω
  - 15 kV (air discharge)
  - 8 kV (contact discharge)
- MIL STD 883G - Method 3015-7: class 3
  - HBM (human body model)

### Description

The ESDAVLC8-1BT2Y is a bidirectional single-line TVS diode designed to protect data lines or other I/O ports against ESD transients.

This device is ideal for applications where both printed circuit board space and power absorption capability are required.

**Figure 1. Functional diagram**

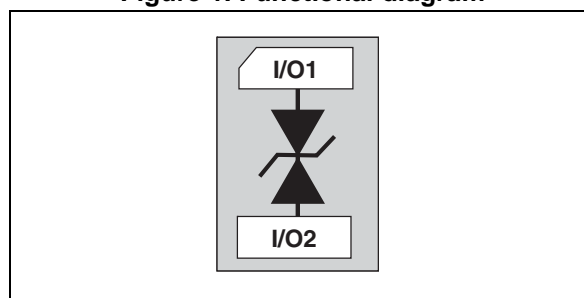

**TM:** Transil is a trademark of STMicroelectronics

Characteristics

ESDAVLC8-1BT2Y

# 1 Characteristics

Table 1. Absolute maximum ratings ( $T_{amb} = 25\text{ }^{\circ}\text{C}$ )

Symbol	Parameter		Value	Unit
$V_{PP}^{(1)}$	Peak pulse voltage	IEC 61000-4-2 contact discharge	17	kV
		IEC 61000-4-2 air discharge	17	
		ISO10605 contact discharge	8	
		ISO10605 air discharge	15	
		MIL STD 883G - Method 3015-7: class 3	25	
$P_{PP}^{(1)}$	Peak pulse power dissipation (8/20 $\mu\text{s}$ )	$T_j \text{ initial} = T_{amb}$	30	W
$I_{PP}$	Peak pulse current (8/20 $\mu\text{s}$ )		1.3	A
$T_{OP}$	Operating junction temperature range		- 50 to + 125	$^{\circ}\text{C}$
$T_{stg}$	Storage temperature range		- 65 to + 125	$^{\circ}\text{C}$
$T_L$	Maximum lead temperature for soldering during 10 s		260	$^{\circ}\text{C}$

1. For a surge greater than the maximum values, the diode will fail in short-circuit.

Figure 2. Electrical characteristics (definitions)

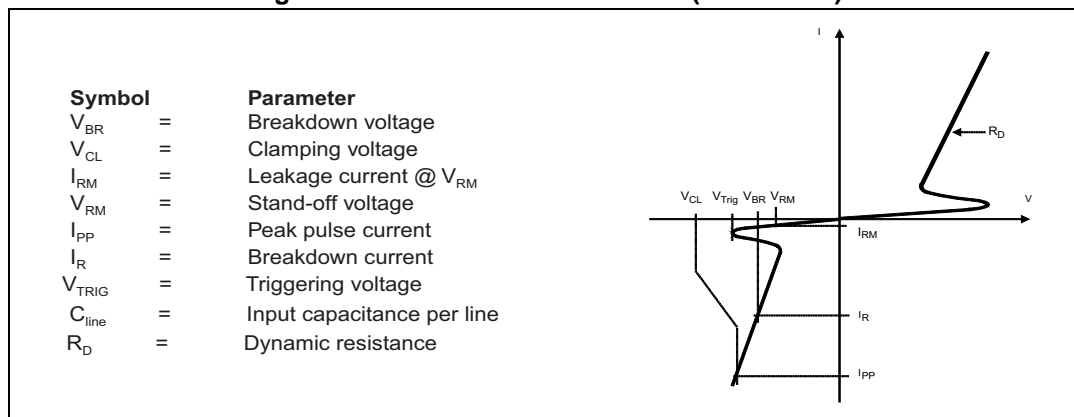

Table 2. Electrical characteristics (values,  $T_{amb} = 25\text{ }^{\circ}\text{C}$ )

Symbol	Test condition	Min.	Typ.	Max.	Unit
$V_{BR}$	From I/O 1 to I/O 2, $I_R = 1\text{ mA}$	14.5	17	20	V
	From I/O 2 to I/O 1, $I_R = 1\text{ mA}$	8.5	11	14	
$I_{RM}$	$V_{RM} = 3\text{ V}$			50	nA
$C_{line}$	$F = 1\text{ MHz}$ , $V_R = 0\text{ V}$		4.5	5.5	pF

**ESDAVLC8-1BT2Y**

**Characteristics**

**Figure 3. Peak pulse power versus initial junction temperature (maximum values)**

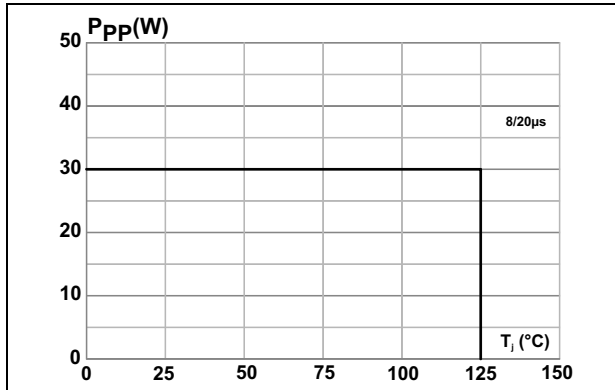

**Figure 4. Junction capacitance versus reverse voltage applied (typical values)**

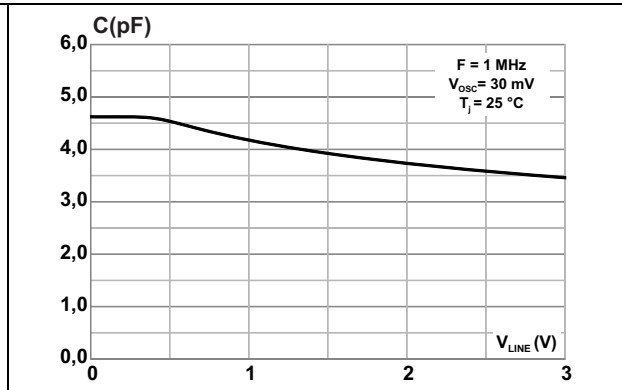

**Figure 5. Peak pulse power versus exponential pulse duration (maximum values)**

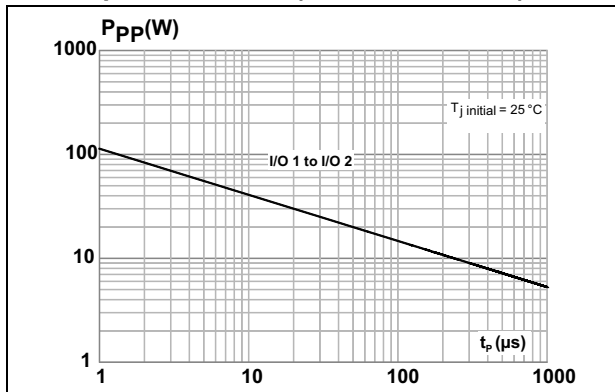

**Figure 6. Peak pulse power versus exponential pulse duration (maximum values)**

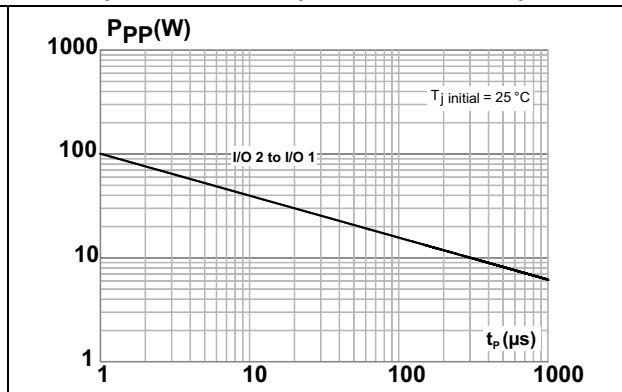

**Figure 7. Clamping voltage versus peak pulse current (maximum values)**

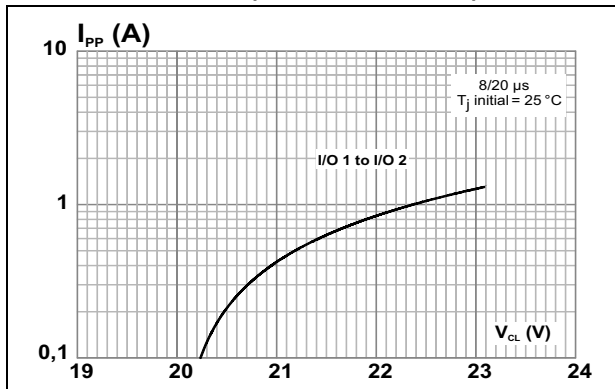

**Figure 8. Clamping voltage versus peak pulse current (maximum values)**

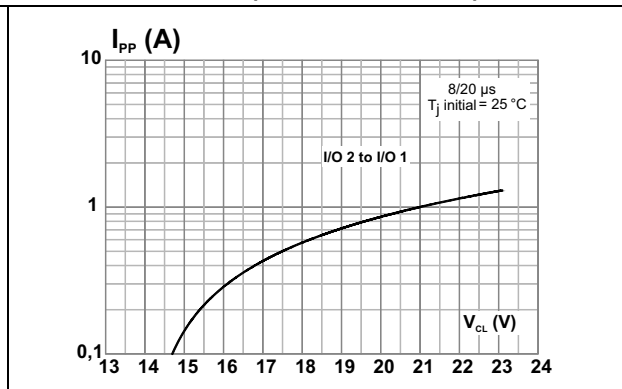

**Characteristics**

**ESDAVLC8-1BT2Y**

**Figure 9. Leakage current versus junction temperature (typical values)**

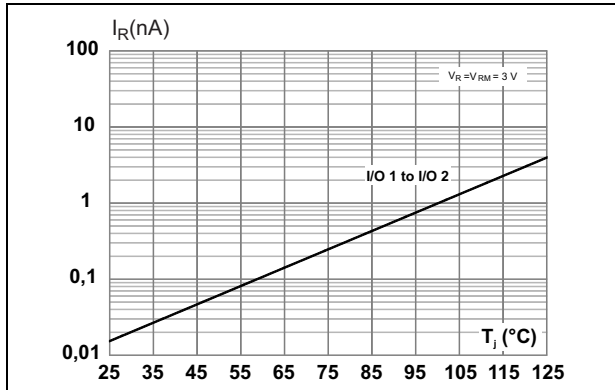

**Figure 10. Leakage current versus junction temperature (typical values)**

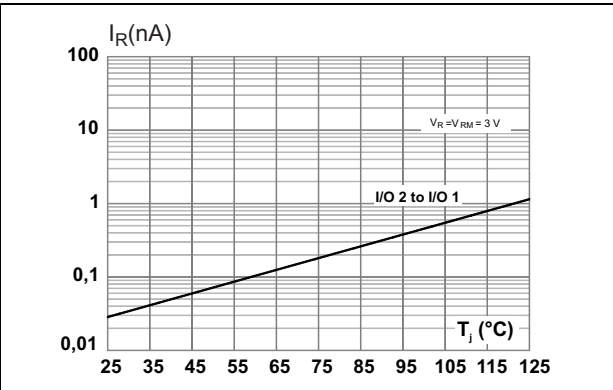

**Figure 11. S21 attenuation measurement result**

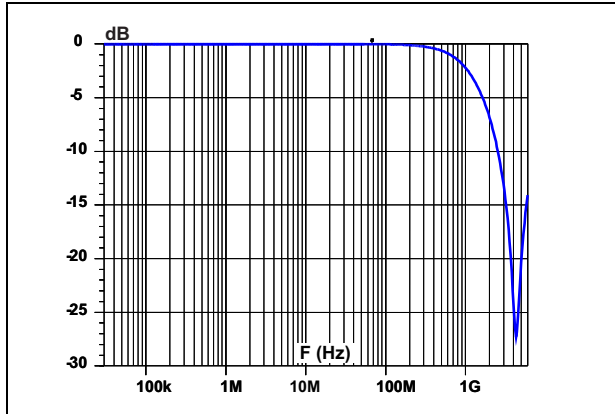

**Figure 12. TLP measurements**

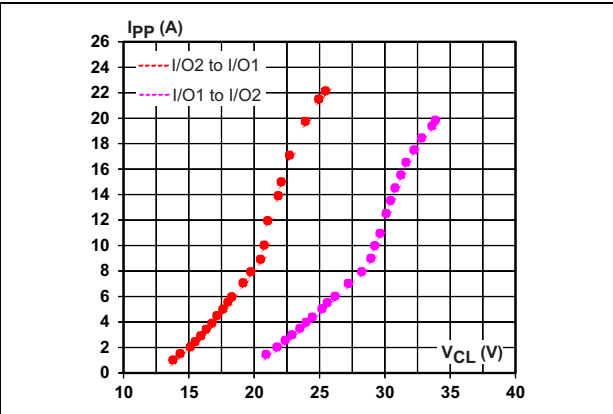

**Figure 13. ESD response to ISO 10605 - C = 150 pF, R = 330 Ω (+8 kV contact)**

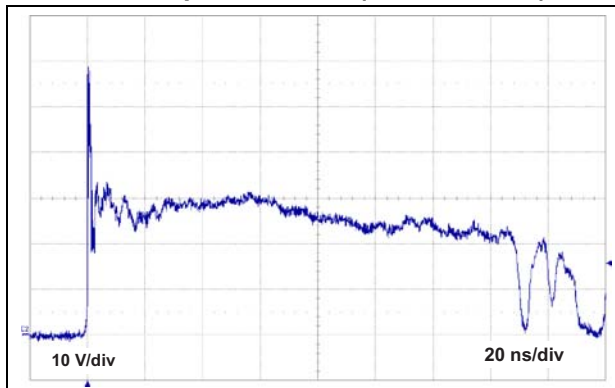

**Figure 14. ESD response to ISO 10605 - C = 150 pF, R = 330 Ω (-8 kV contact)**

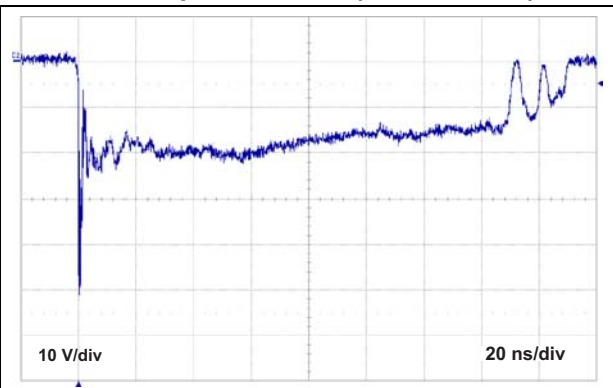

**ESDAVLC8-1BT2Y**

**Characteristics**

**Figure 15. Response to ISO 7637-3 Pulse 3a  
 (Us = -150 V)**

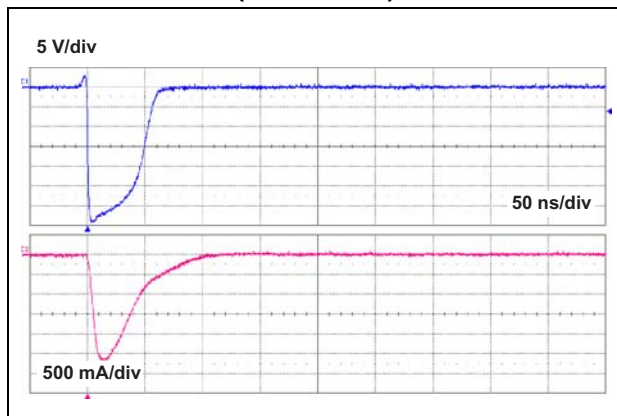

**Figure 16. Response to ISO 7637-3 Pulse 3b  
 (Us = +100 V)**

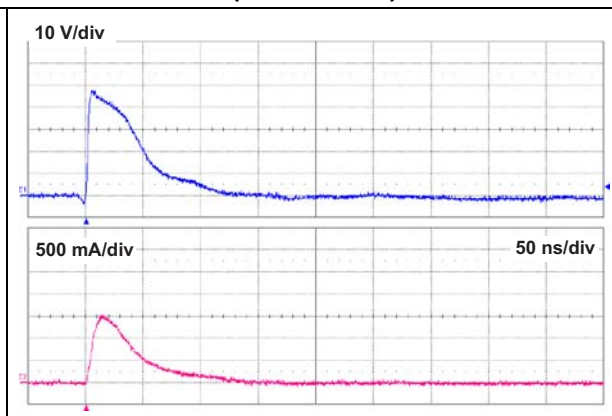

## 2 Package information

- Epoxy meets UL94, V0
- Lead-free packages

In order to meet environmental requirements, ST offers these devices in different grades of ECOPACK® packages, depending on their level of environmental compliance. ECOPACK® specifications, grade definitions and product status are available at: [www.st.com](http://www.st.com). ECOPACK® is an ST trademark.

**Figure 17. SOD882T dimension definitions**

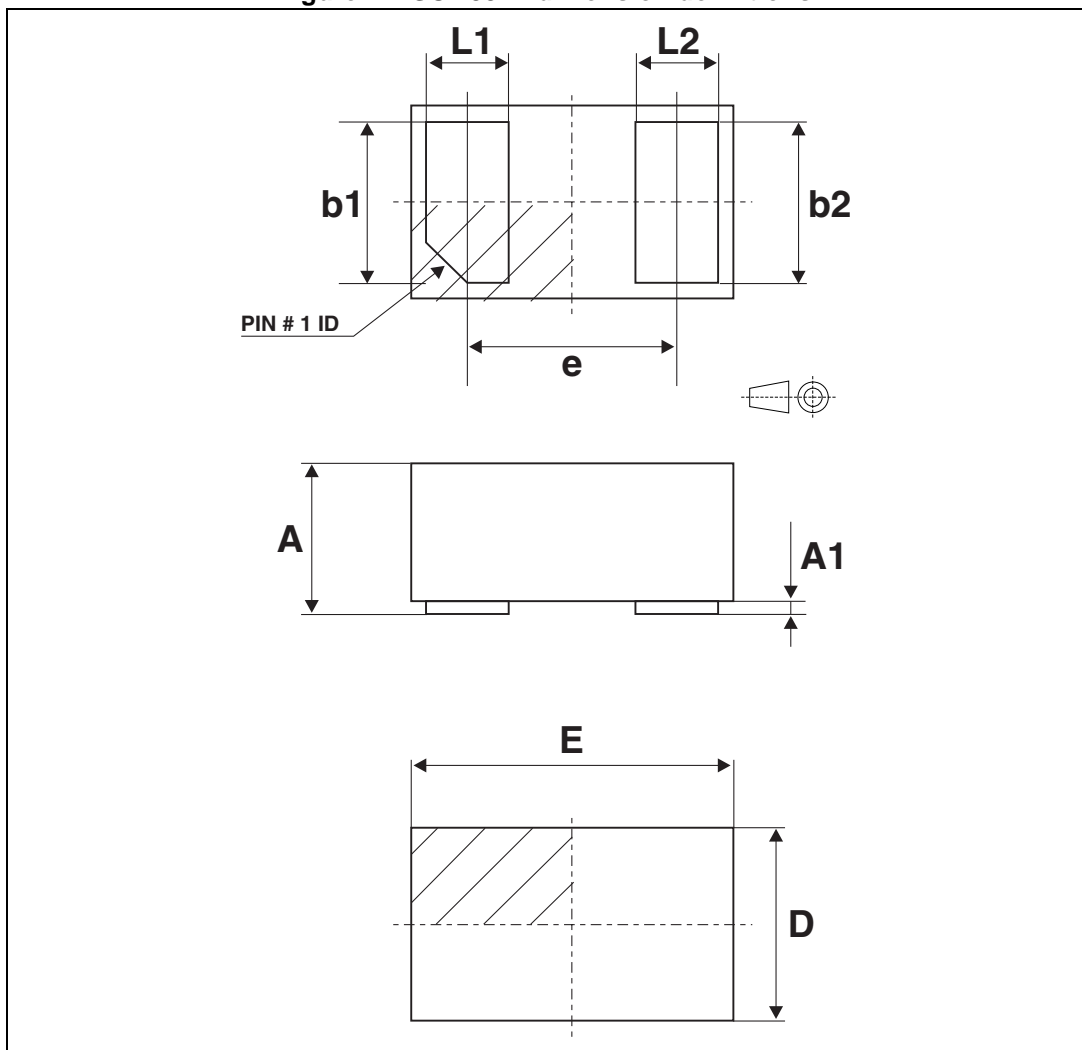

ESDAVLC8-1BT2Y

Package information

Table 3. SOD882T dimension values

Ref.	Dimensions					
	Millimeters			Inches		
	Min.	Typ.	Max.	Min.	Typ.	Max.
A	0.30		0.40	0.012		0.016
A1	0.00		0.05	0.000		0.002
b1	0.45	0.50	0.55	0.018	0.020	0.022
b2	0.45	0.50	0.55	0.018	0.020	0.022
D	0.55	0.60	0.65	0.022	0.024	0.026
E	0.95	1.00	1.05	0.037	0.039	0.041
e	0.60	0.65	0.70	0.024	0.026	0.028
L1	0.20	0.25	0.30	0.008	0.010	0.012
L2	0.20	0.25	0.30	0.008	0.010	0.012

Figure 18. SOD882T footprint in mm (inches)

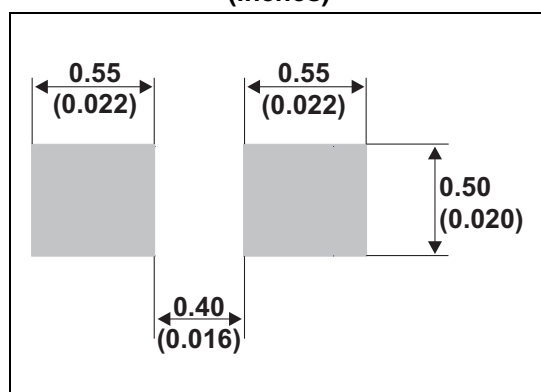
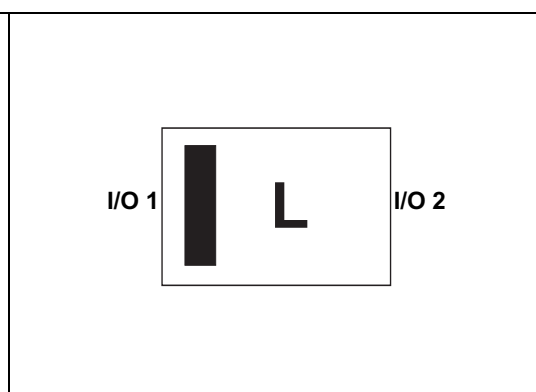

Figure 19. SOD882T marking



Note: Product marking may be rotated by multiples of 90° for assembly plant differentiation. In no case should this product marking be used to orient the component for its placement on a PCB. Only pin 1 mark is to be used for this purpose.



Package information

ESDAVLC8-1BT2Y

Figure 20. SOD882T tape and reel specifications

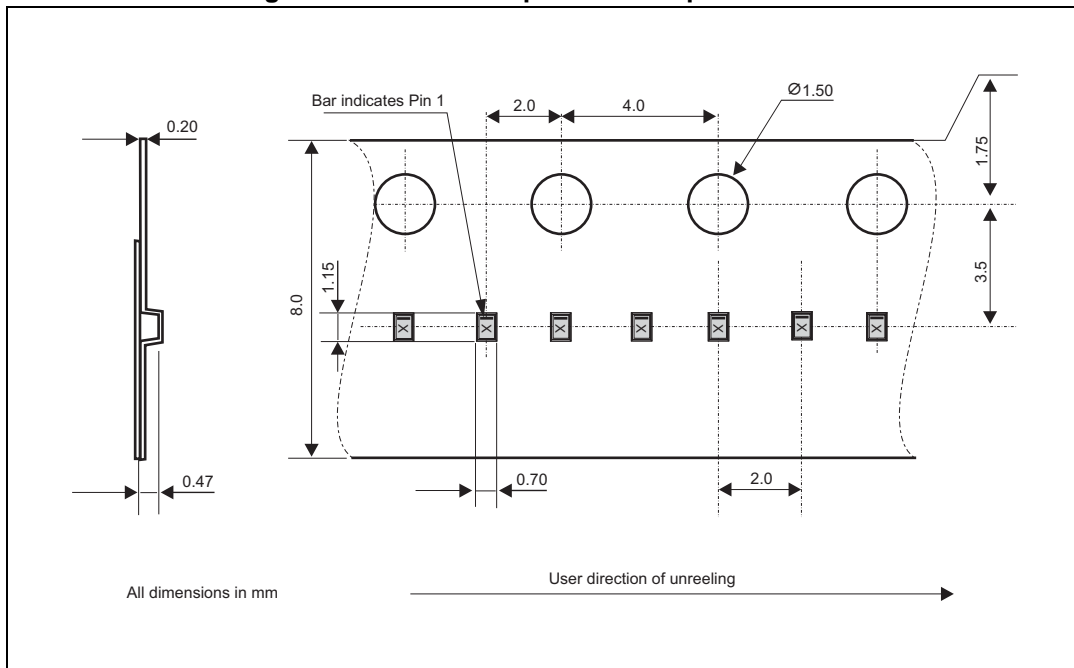

### 3 Recommendation on PCB assembly

#### 3.1 Stencil opening design

1. General recommendation on stencil opening design
  - a) Stencil opening dimensions: L (Length), W (Width), T (Thickness).

**Figure 21. Stencil opening dimensions**

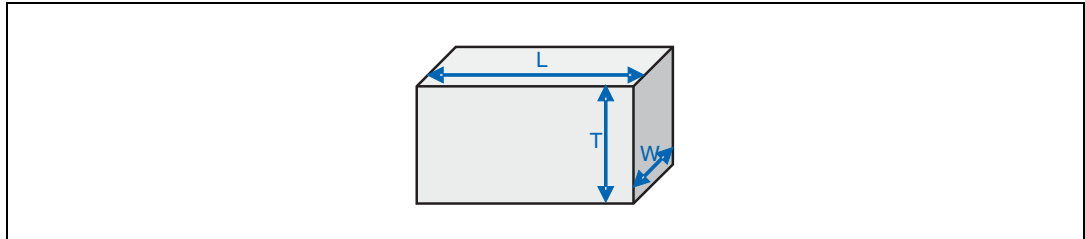

- b) General design rule
 

Stencil thickness (T) = 75 ~ 125 μm

$$\text{Aspect Ratio} = \frac{W}{T} \geq 1.5$$

$$\text{Aspect Area} = \frac{L \times W}{2T(L + W)} \geq 0.66$$

2. Reference design
  - a) Stencil opening thickness: 100 μm
  - b) Stencil opening for central exposed pad: Opening to footprint ratio is 50%.
  - c) Stencil opening for leads: Opening to footprint ratio is 90%.

**Figure 22. Recommended stencil window position in mm (inches)**

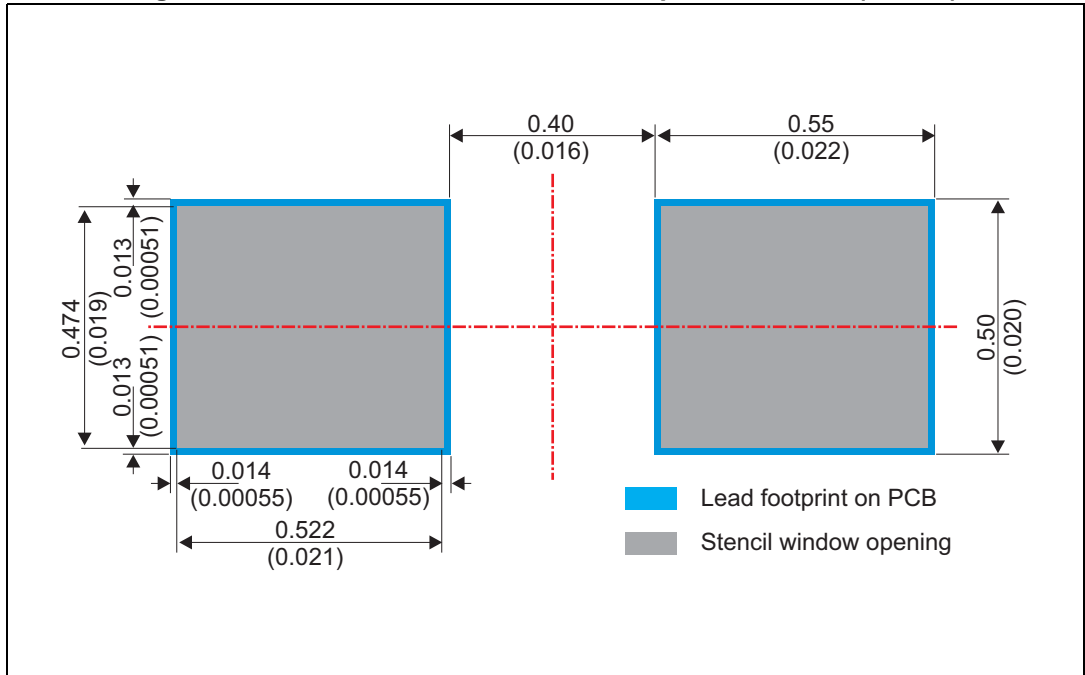

### 3.2 Solder paste

1. Halide-free flux qualification ROL0 according to ANSI/J-STD-004.
2. "No clean" solder paste is recommended.
3. Offers a high tack force to resist component movement during high speed.
4. Solder paste with fine particles: powder particle size is 20-45  $\mu\text{m}$ .

### 3.3 Placement

1. Manual positioning is not recommended.
2. It is recommended to use the lead recognition capabilities of the placement system, not the outline centering.
3. Standard tolerance of  $\pm 0.05$  mm is recommended.
4. 3.5 N placement force is recommended. Too much placement force can lead to squeezed out solder paste and cause solder joints to short. Too low placement force can lead to insufficient contact between package and solder paste that could cause open solder joints or badly centered packages.
5. To improve the package placement accuracy, a bottom side optical control should be performed with a high resolution tool.
6. For assembly, a perfect supporting of the PCB (all the more on flexible PCB) is recommended during solder paste printing, pick and place and reflow soldering by using optimized tools.

### 3.4 PCB design preference

1. To control the solder paste amount, the closed via is recommended instead of open vias.
2. The position of tracks and open vias in the solder area should be well balanced. The symmetrical layout is recommended, in case any tilt phenomena caused by asymmetrical solder paste amount due to the solder flow away.

### 3.5 Reflow profile

Figure 23. ST ECOPACK® recommended soldering reflow profile for PCB mounting

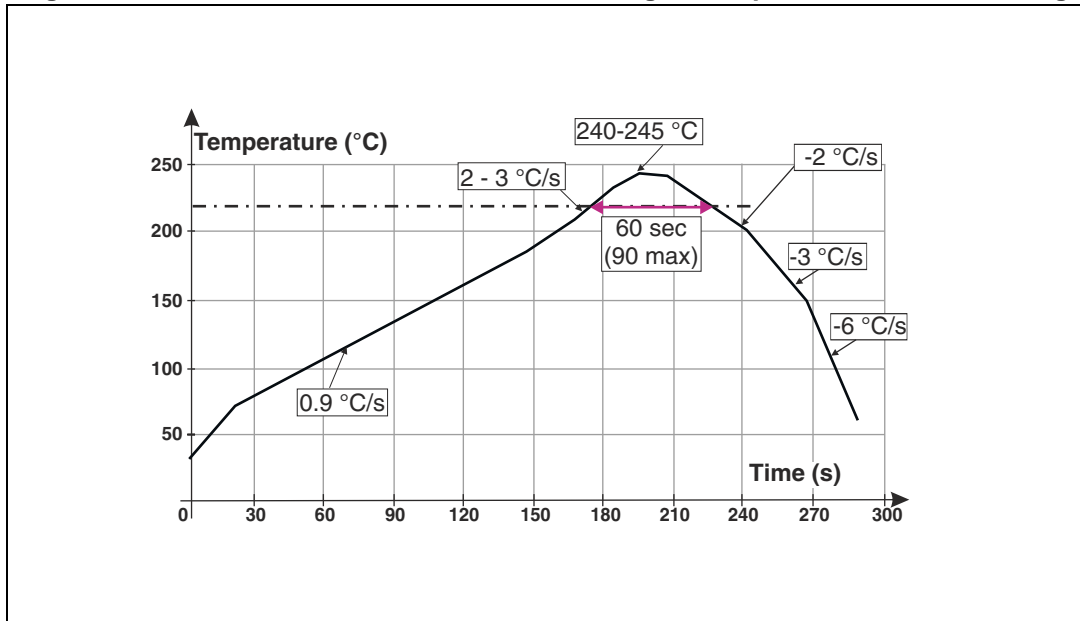

Note: Minimize air convection currents in the reflow oven to avoid component movement.

## 4 Ordering information

Figure 24. Ordering information scheme

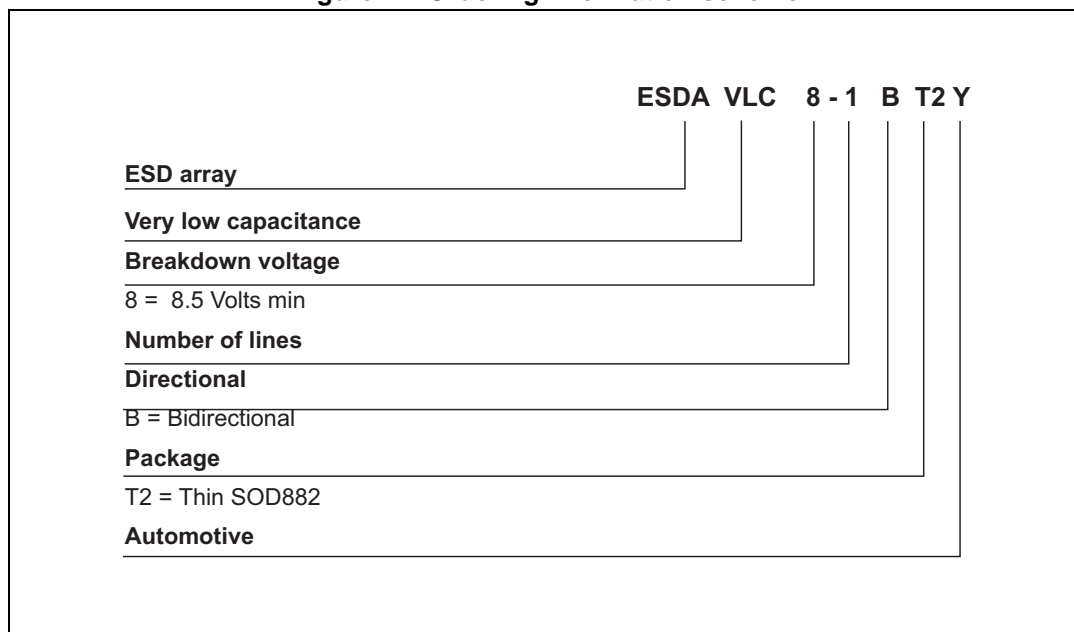

Table 4. Ordering information

Order code	Marking <sup>(1)</sup>	Package	Weight	Base qty	Delivery mode
ESDAVLC8-1BT2Y	L	SOD882T	0.81 mg	12000	Tape and reel

1. The marking can be rotated by multiples of 90° to differentiate assembly location

## 5 Revision history

Table 5. Document revision history

Date	Revision	Changes
09-Dec-2013	1	Initial release.
15-Jul-2014	2	Added <a href="#">Figure 13</a> , <a href="#">Figure 14</a> , <a href="#">Figure 15</a> and <a href="#">Figure 16</a> .

## ESDAVLC8-1BT2Y

---

### **IMPORTANT NOTICE – PLEASE READ CAREFULLY**

STMicroelectronics NV and its subsidiaries (“ST”) reserve the right to make changes, corrections, enhancements, modifications, and improvements to ST products and/or to this document at any time without notice. Purchasers should obtain the latest relevant information on ST products before placing orders. ST products are sold pursuant to ST’s terms and conditions of sale in place at the time of order acknowledgement.

Purchasers are solely responsible for the choice, selection, and use of ST products and ST assumes no liability for application assistance or the design of Purchasers’ products.

No license, express or implied, to any intellectual property right is granted by ST herein.

Resale of ST products with provisions different from the information set forth herein shall void any warranty granted by ST for such product.

ST and the ST logo are trademarks of ST. All other product or service names are the property of their respective owners.

Information in this document supersedes and replaces information previously supplied in any prior versions of this document.

© 2014 STMicroelectronics – All rights reserved