

Excellent Integrated System Limited

Stocking Distributor

Click to view price, real time Inventory, Delivery & Lifecycle Information:

[STMicroelectronics](#)

[STGWT80V60DF](#)

For any questions, you can email us directly:

sales@integrated-circuit.com



STGW80V60DF STGWT80V60DF

Trench gate field-stop IGBT, V series
600 V, 80 A very high speed

Datasheet - production data

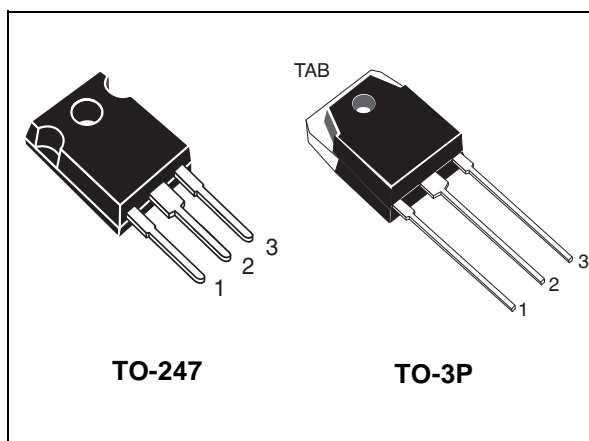
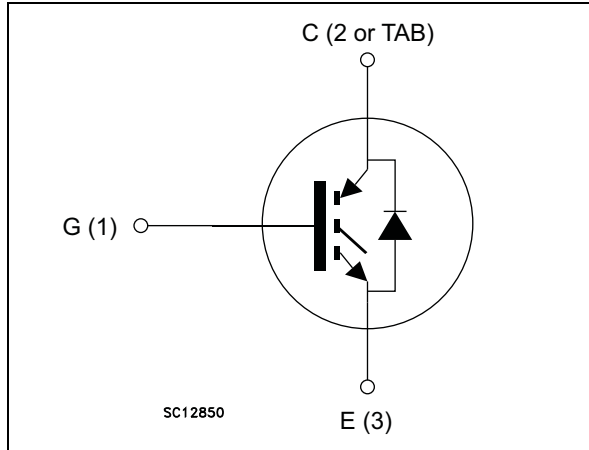

Figure 1. Internal schematic diagram



Features

- Maximum junction temperature: $T_J = 175\text{ °C}$
- Tail-less switching off
- $V_{CE(sat)} = 1.85\text{ V (typ.) @ } I_C = 80\text{ A}$
- Tight parameters distribution
- Safe paralleling
- Low thermal resistance
- Very fast soft recovery antiparallel diode

Applications

- Photovoltaic inverters
- Uninterruptible power supply
- Welding
- Power factor correction
- Very high frequency converters

Description

This device is an IGBT developed using an advanced proprietary trench gate field stop structure. The device is part of the V series of IGBTs, which represent an optimum compromise between conduction and switching losses to maximize the efficiency of very high frequency converters. Furthermore, a positive $V_{CE(sat)}$ temperature coefficient and very tight parameter distribution result in safer paralleling operation.

Table 1. Device summary

Order code	Marking	Package	Packaging
STGW80V60DF	GW80V60DF	TO-247	Tube
STGWT80V60DF	GWT80V60DF	TO-3P	Tube

Contents

1	Electrical ratings	2
2	Electrical characteristics	3
	2.1 Electrical characteristics (curves)	5
3	Test circuits	10
4	Package mechanical data	11
5	Revision history	15

1 Electrical ratings

Table 2. Absolute maximum ratings

Symbol	Parameter	Value	Unit
V_{CES}	Collector-emitter voltage ($V_{GE} = 0$)	600	V
I_C	Continuous collector current at $T_C = 25\text{ °C}$	120 ⁽¹⁾	A
I_C	Continuous collector current at $T_C = 100\text{ °C}$	80	A
I_{CP} ⁽²⁾	Pulsed collector current	240	A
V_{GE}	Gate-emitter voltage	± 20	V
I_F	Continuous forward current at $T_C = 25\text{ °C}$	120 ⁽¹⁾	A
I_F	Continuous forward current at $T_C = 100\text{ °C}$	80	A
I_{FP} ⁽²⁾	Pulsed forward current	360	A
P_{TOT}	Total dissipation at $T_C = 25\text{ °C}$	469	W
T_{STG}	Storage temperature range	- 55 to 150	°C
T_J	Operating junction temperature	- 55 to 175	°C

1. Current level is limited by bond wires
2. Pulse width limited by maximum junction temperature

Table 3. Thermal data

Symbol	Parameter	Value	Unit
R_{thJC}	Thermal resistance junction-case IGBT	0.32	°C/W
R_{thJC}	Thermal resistance junction-case diode	0.66	°C/W
R_{thJA}	Thermal resistance junction-ambient	50	°C/W

Electrical characteristics

STGW80V60DF, STGWT80V60DF

2 Electrical characteristics

T_J = 25 °C unless otherwise specified.

Table 4. Static characteristics

Symbol	Parameter	Test conditions	Min.	Typ.	Max.	Unit
V _{(BR)CES}	Collector-emitter breakdown voltage (V _{GE} = 0)	I _C = 2 mA	600			V
V _{CE(sat)}	Collector-emitter saturation voltage	V _{GE} = 15 V, I _C = 80 A		1.85	2.3	V
		V _{GE} = 15 V, I _C = 80 A T _J = 125 °C		2.15		
		V _{GE} = 15 V, I _C = 80 A T _J = 175 °C		2.4		
V _F	Forward on-voltage	I _F = 80 A		1.9	2.3	V
		I _F = 80 A T _J = 125 °C		1.6		V
		I _F = 80 A T _J = 175 °C		1.5		V
V _{GE(th)}	Gate threshold voltage	V _{CE} = V _{GE} , I _C = 1 mA	5	6	7	V
I _{CES}	Collector cut-off current (V _{GE} = 0)	V _{CE} = 600 V			100	μA
I _{GES}	Gate-emitter leakage current (V _{CE} = 0)	V _{GE} = ± 20 V			250	nA

STGW80V60DF, STGWT80V60DF
Electrical characteristics
Table 5. Dynamic characteristics

Symbol	Parameter	Test conditions	Min.	Typ.	Max.	Unit
C_{ies}	Input capacitance	$V_{CE} = 25\text{ V}$, $f = 1\text{ MHz}$, $V_{GE} = 0$	-	10800	-	nF
C_{oes}	Output capacitance		-	390	-	pF
C_{res}	Reverse transfer capacitance		-	220	-	pF
Q_g	Total gate charge	$V_{CC} = 480\text{ V}$, $I_C = 80\text{ A}$, $V_{GE} = 15\text{ V}$, see Figure 29	-	448	-	nC
Q_{ge}	Gate-emitter charge		-	76	-	nC
Q_{gc}	Gate-collector charge		-	184	-	nC

Table 6. IGBT switching characteristics (inductive load)

Symbol	Parameter	Test conditions	Min.	Typ.	Max.	Unit
$t_{d(on)}$	Turn-on delay time	$V_{CE} = 400\text{ V}$, $I_C = 80\text{ A}$, $R_G = 5\ \Omega$, $V_{GE} = 15\text{ V}$, see Figure 28	-	60	-	ns
t_r	Current rise time		-	30	-	ns
$(di/dt)_{on}$	Turn-on current slope		-	2200	-	A/ μ s
$t_{d(off)}$	Turn-off delay time		-	220	-	ns
t_f	Current fall time		-	17	-	ns
$E_{on}^{(1)}$	Turn-on switching losses		-	1.8	-	mJ
$E_{off}^{(2)}$	Turn-off switching losses		-	1	-	mJ
E_{ts}	Total switching losses		-	2.8	-	mJ
$t_{d(on)}$	Turn-on delay time		$V_{CE} = 400\text{ V}$, $I_C = 80\text{ A}$, $R_G = 5\ \Omega$, $V_{GE} = 15\text{ V}$, $T_J = 175\text{ }^\circ\text{C}$, see Figure 28	-	60	-
t_r	Current rise time	-		30	-	ns
$(di/dt)_{on}$	Turn-on current slope	-		2100	-	A/ μ s
$t_{d(off)}$	Turn-off delay time	-		240	-	ns
t_f	Current fall time	-		22	-	ns
$E_{on}^{(1)}$	Turn-on switching losses	-		3.8	-	mJ
$E_{off}^{(2)}$	Turn-off switching losses	-		1.25	-	mJ
E_{ts}	Total switching losses	-		5.05	-	mJ

1. Energy losses include reverse recovery of the diode.
2. Turn-off losses include also the tail of the collector current.

Electrical characteristics

STGW80V60DF, STGWT80V60DF

Table 7. Diode switching characteristics (inductive load)

Symbol	Parameter	Test conditions	Min.	Typ.	Max.	Unit
t_{rr}	Reverse recovery time	$I_F = 80\text{ A}$, $V_R = 400\text{ V}$, $di/dt = 1000\text{ A}/\mu\text{s}$, $V_{GE} = 15\text{ V}$, see Figure 28	-	60	-	ns
Q_{rr}	Reverse recovery charge		-	112	-	nC
I_{rrm}	Reverse recovery current		-	3.6	-	A
dl_{rr}/dt	Peak rate of fall of reverse recovery current during t_b		-	140	-	$\text{A}/\mu\text{s}$
E_{rr}	Reverse recovery energy		-	70	-	μJ
t_{rr}	Reverse recovery time	$I_F = 80\text{ A}$, $V_R = 400\text{ V}$, $di/dt = 1000\text{ A}/\mu\text{s}$, $V_{GE} = 15\text{ V}$; $T_J = 175\text{ }^\circ\text{C}$ see Figure 28	-	340	-	ns
Q_{rr}	Reverse recovery charge		-	2200	-	nC
I_{rrm}	Reverse recovery current		-	13	-	A
dl_{rr}/dt	Peak rate of fall of reverse recovery current during t_b		-	70	-	$\text{A}/\mu\text{s}$
E_{rr}	Reverse recovery energy		-	880	-	μJ

STGW80V60DF, STGWT80V60DF

Electrical characteristics

2.1 Electrical characteristics (curves)

Figure 2. Power dissipation vs. case temperature

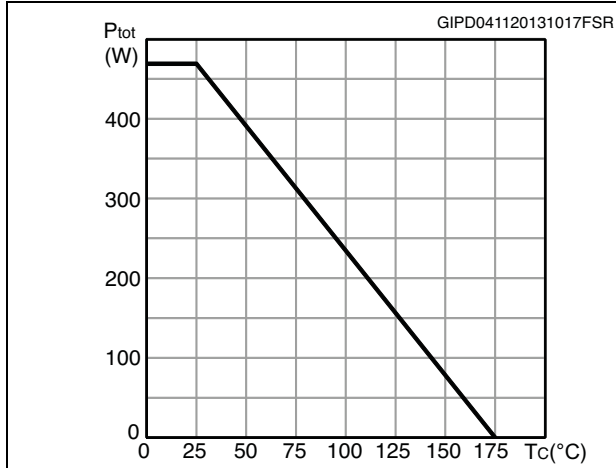

Figure 3. Collector current vs. case temperature

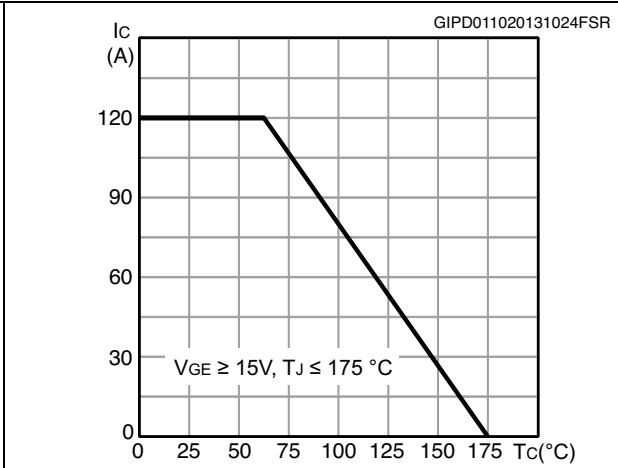

Figure 4. Output characteristics (T_J = 25°C)

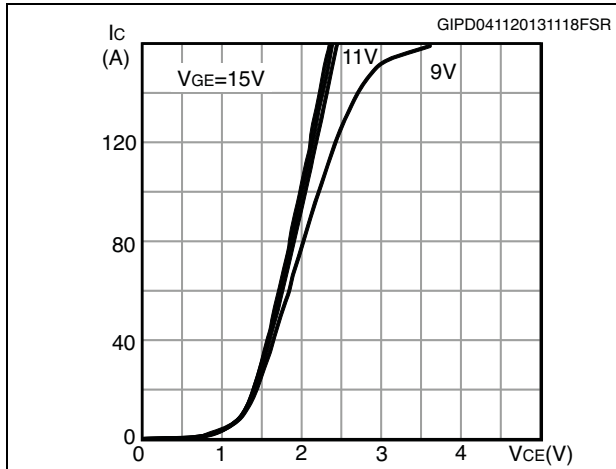

Figure 5. Output characteristics (T_J = 175°C)

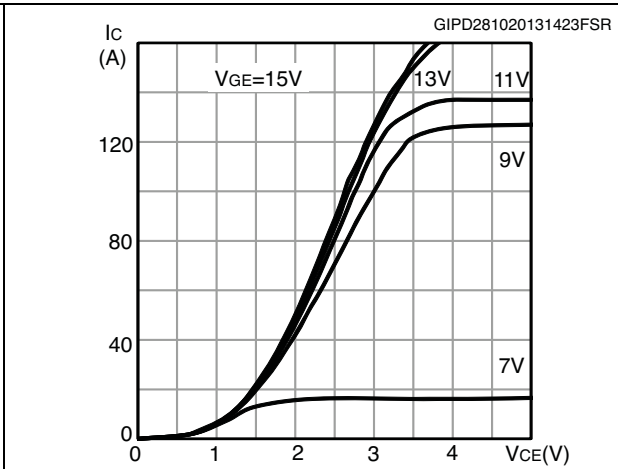

Figure 6. V_{CE(sat)} vs. junction temperature

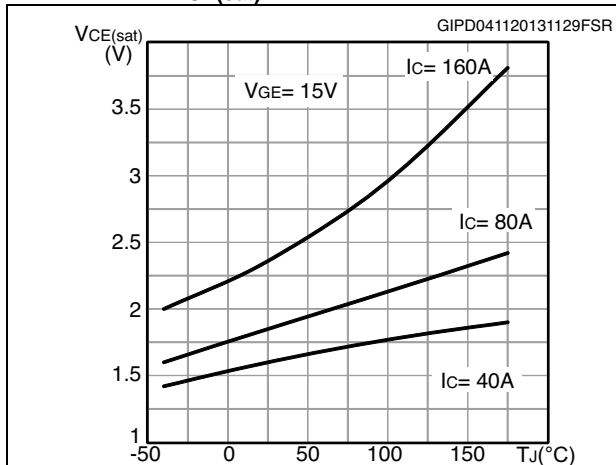
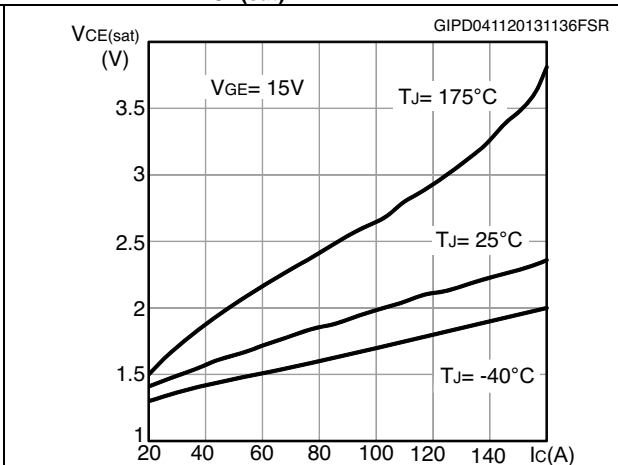

Figure 7. V_{CE(sat)} vs. collector current



Electrical characteristics

STGW80V60DF, STGWT80V60DF

Figure 8. Collector current vs. switching frequency

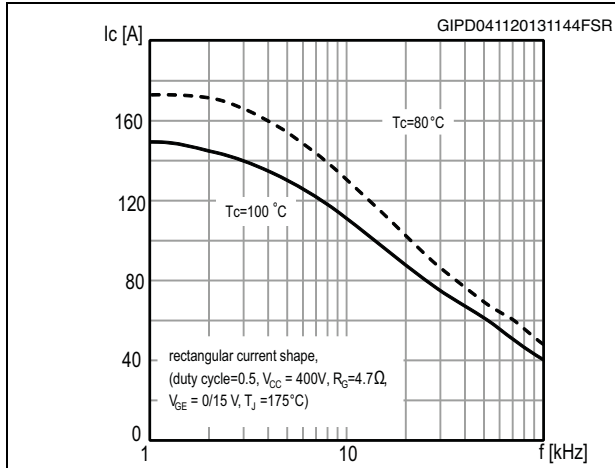

Figure 9. Forward bias safe operating area

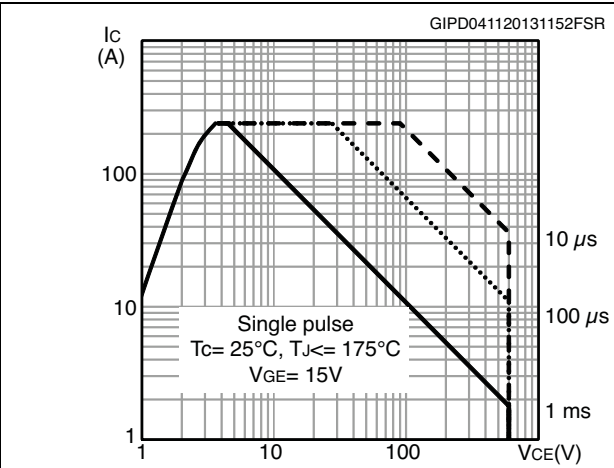

Figure 10. Transfer characteristics

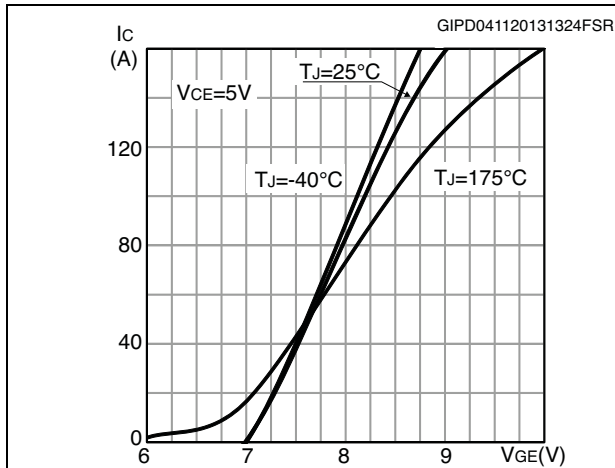

Figure 11. Diode VF vs. forward current

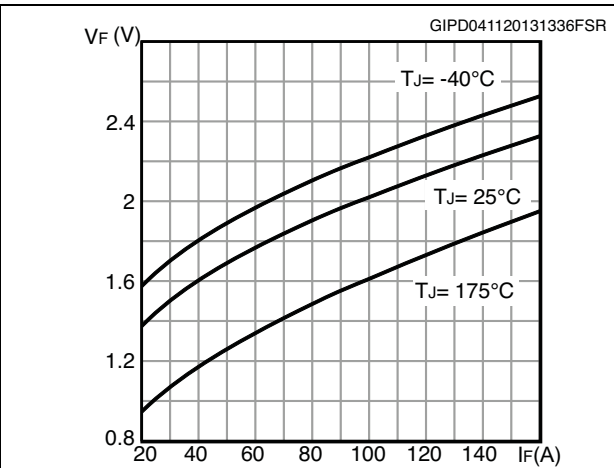

Figure 12. Normalized VGE(th) vs junction temperature

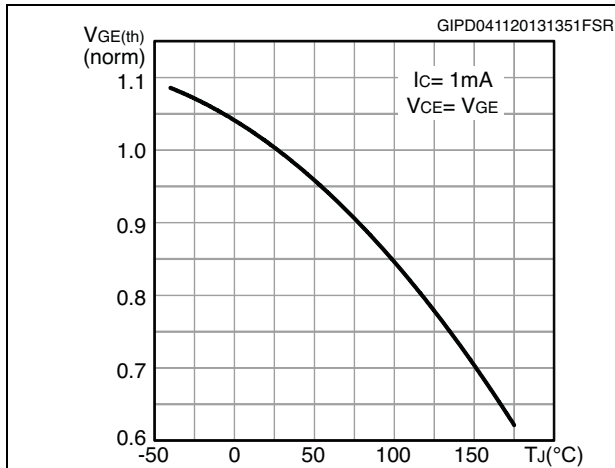
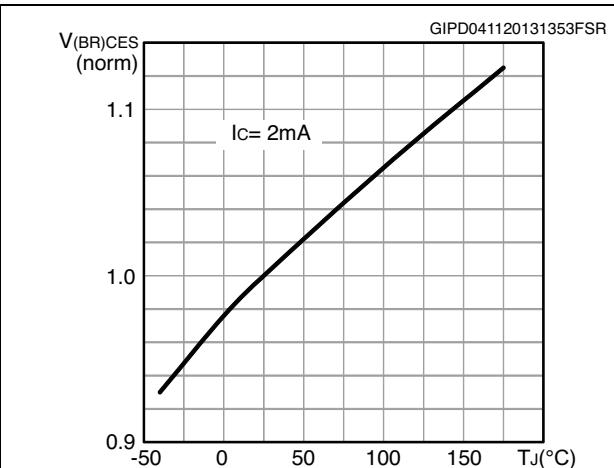

Figure 13. Normalized V(BR)CES vs. junction temperature



STGW80V60DF, STGWT80V60DF

Electrical characteristics

Figure 14. Capacitance variation

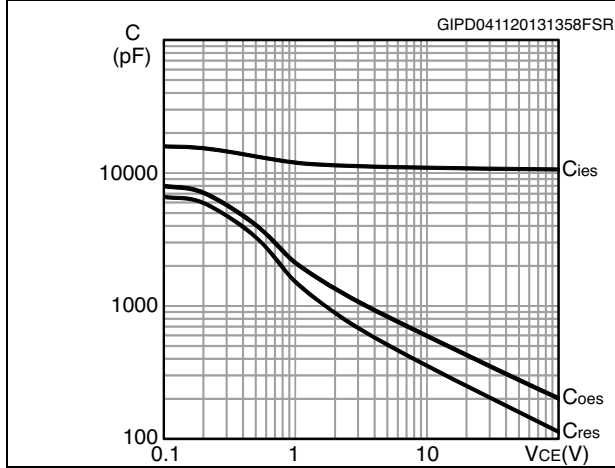

Figure 15. Gate charge vs. gate-emitter voltage

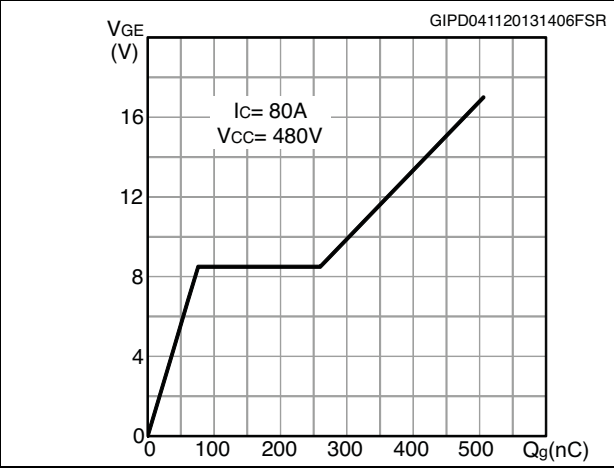

Figure 16. Switching loss vs collector current

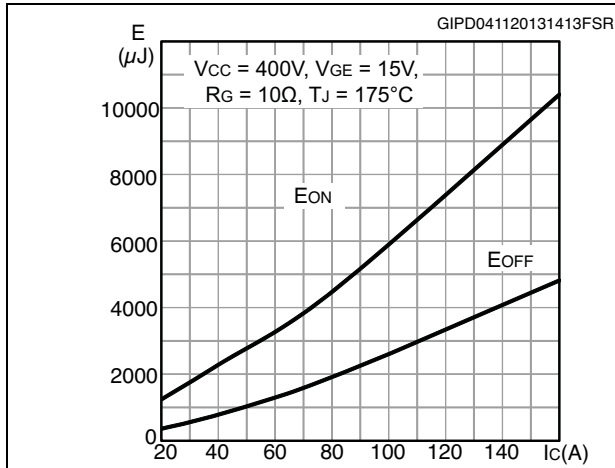

Figure 17. Switching loss vs gate resistance

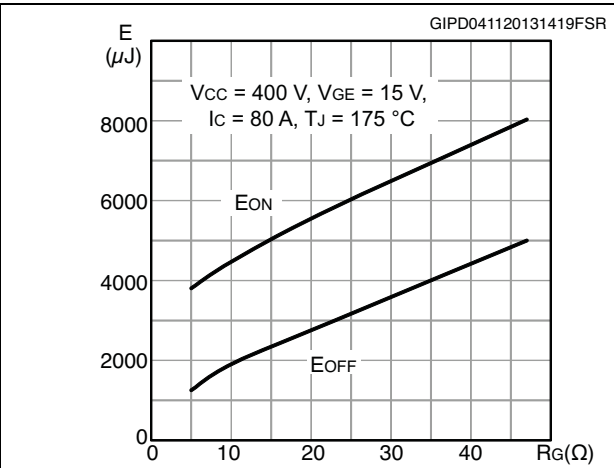

Figure 18. Switching loss vs temperature

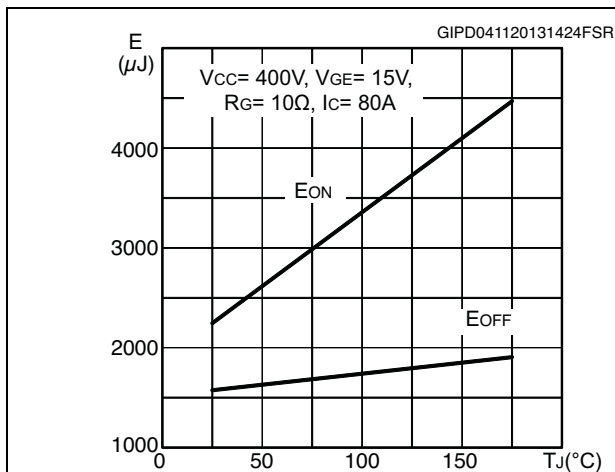
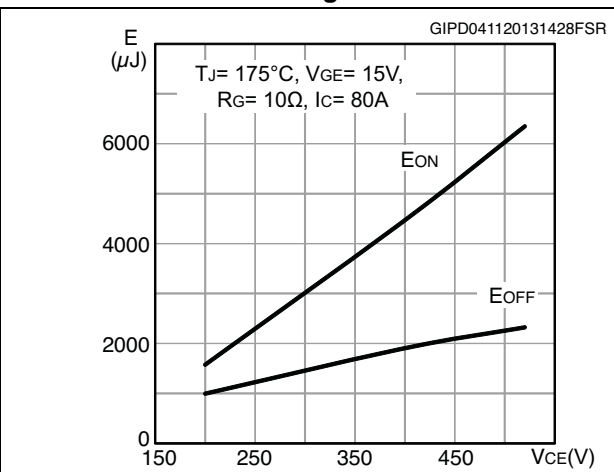

Figure 19. Switching loss vs collector-emitter voltage



Electrical characteristics

STGW80V60DF, STGWT80V60DF

Figure 20. Switching times vs. collector current **Figure 21. Switching times vs. gate resistance**

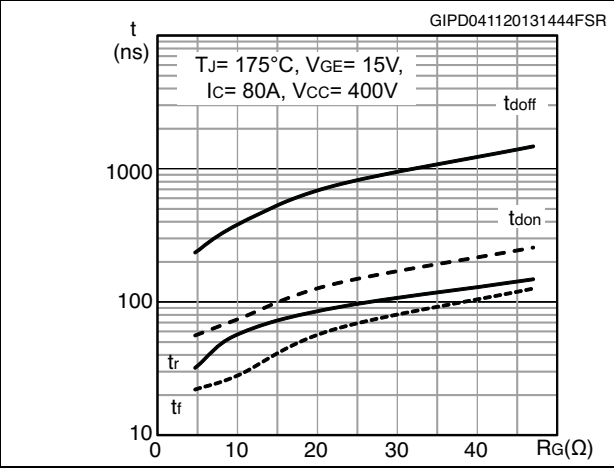
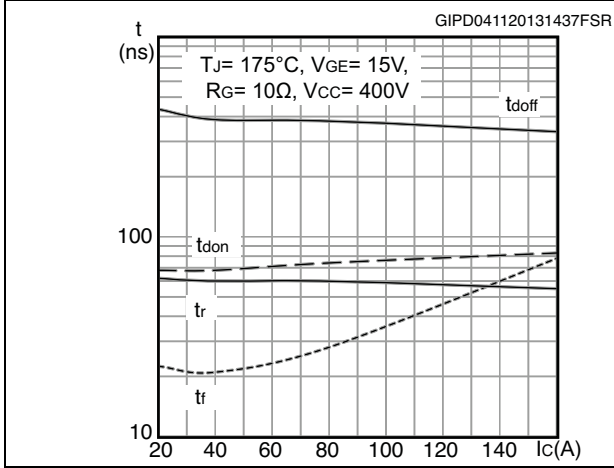

Figure 22. Reverse recovery current vs. diode current slope

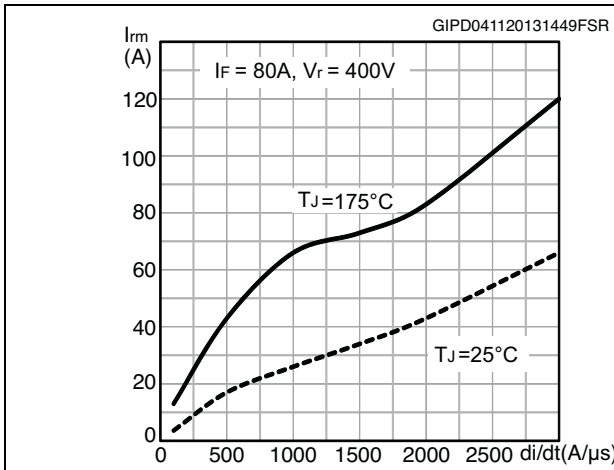

Figure 23. Reverse recovery time vs. diode current slope

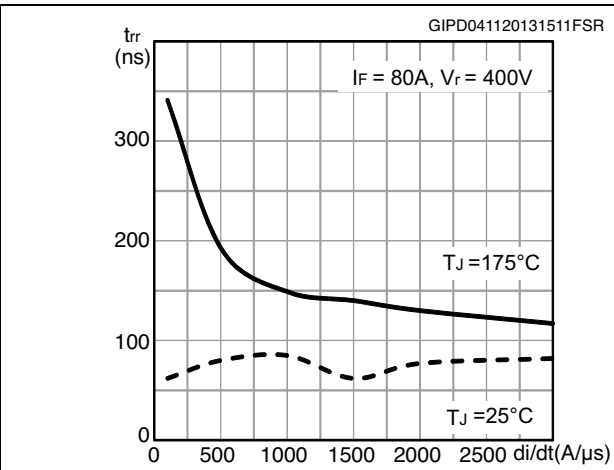

Figure 24. Reverse recovery charge vs. diode current slope

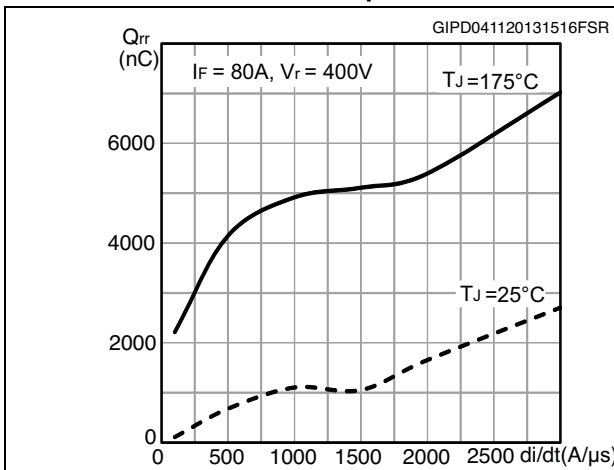
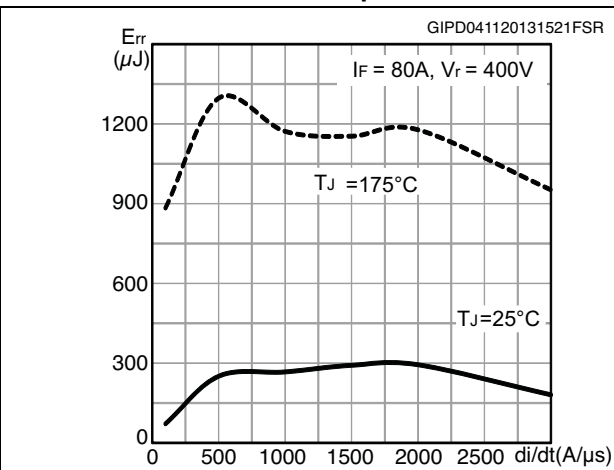

Figure 25. Reverse recovery energy vs. diode current slope



STGW80V60DF, STGWT80V60DF

Electrical characteristics

Figure 26. Thermal impedance for IGBT

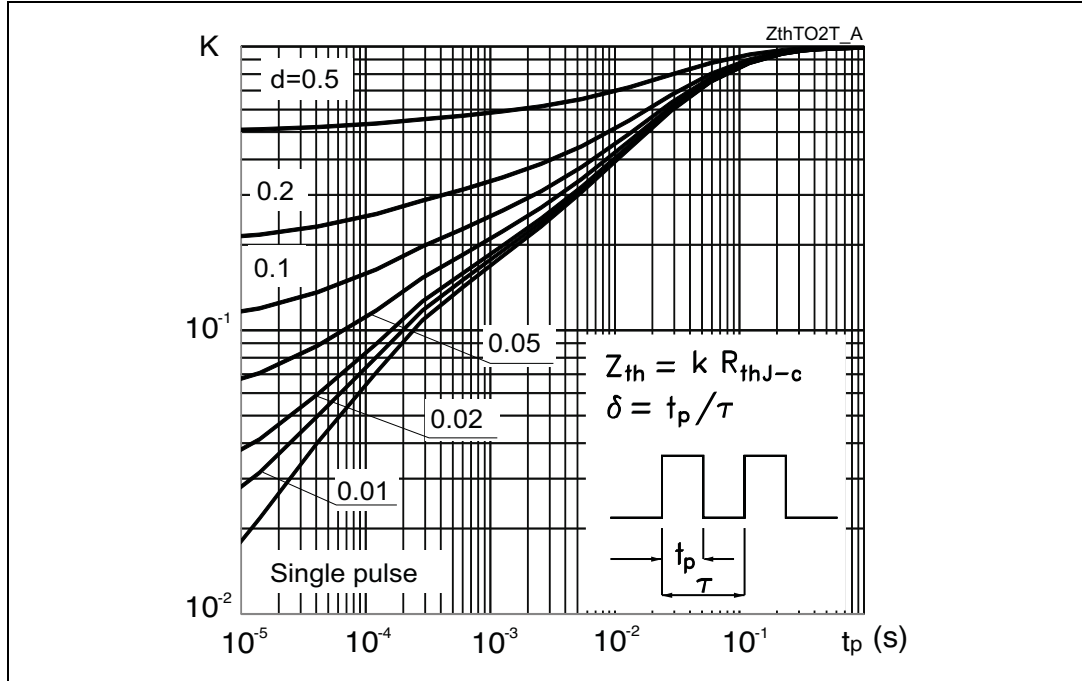
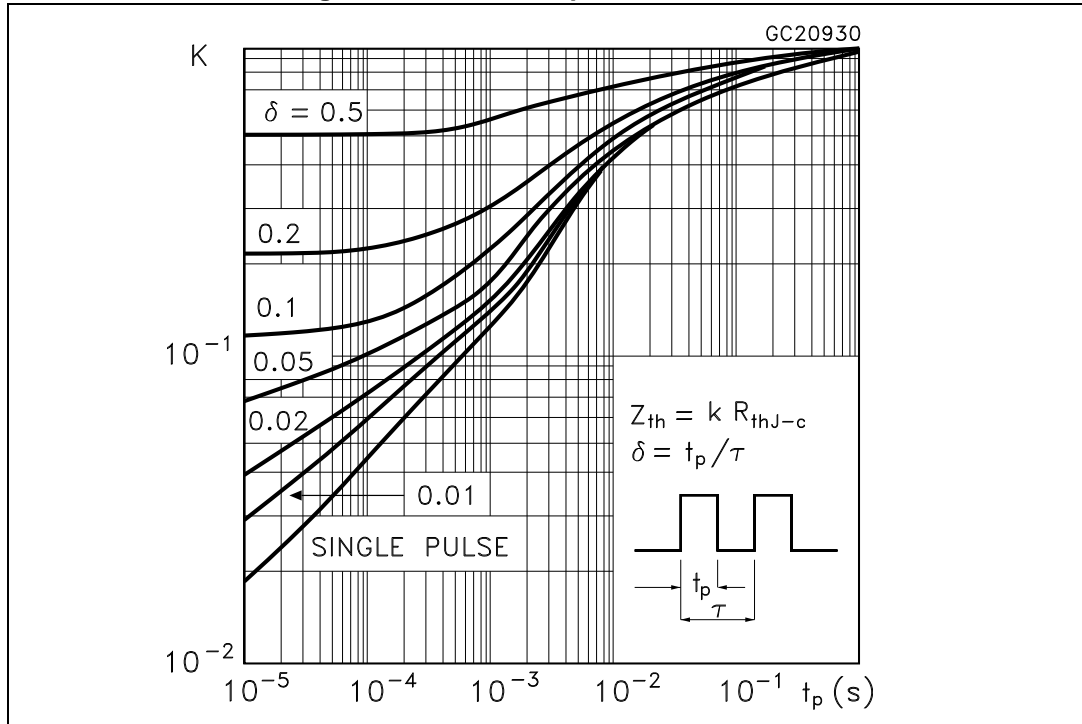

Figure 27. Thermal impedance for diode



Test circuits

STGW80V60DF, STGWT80V60DF

3 Test circuits

Figure 28. Test circuit for inductive load switching

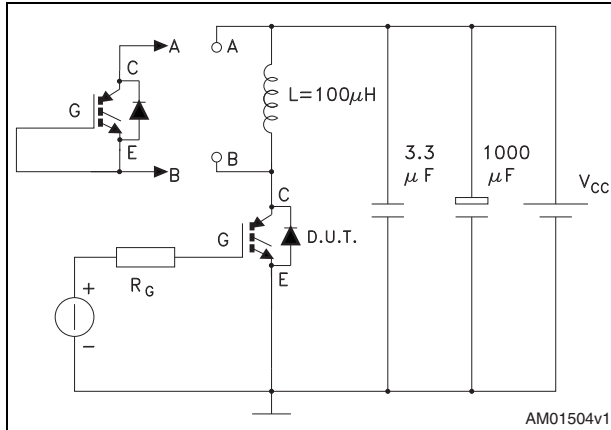

Figure 29. Gate charge test circuit

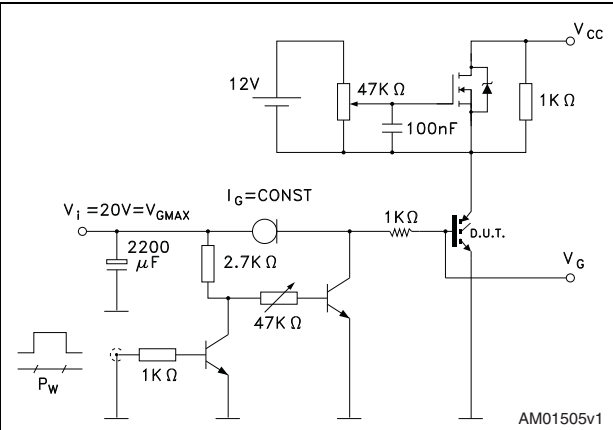

Figure 30. Switching waveform

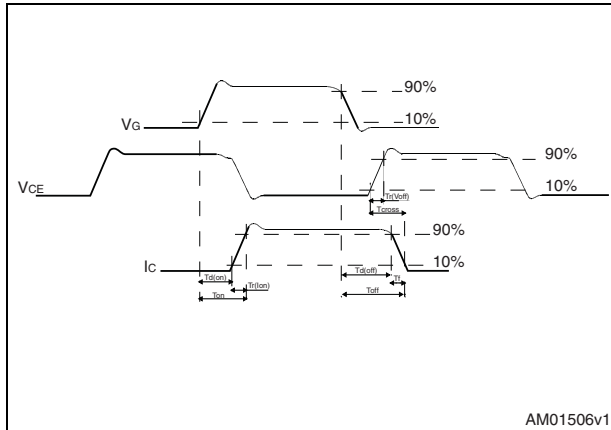
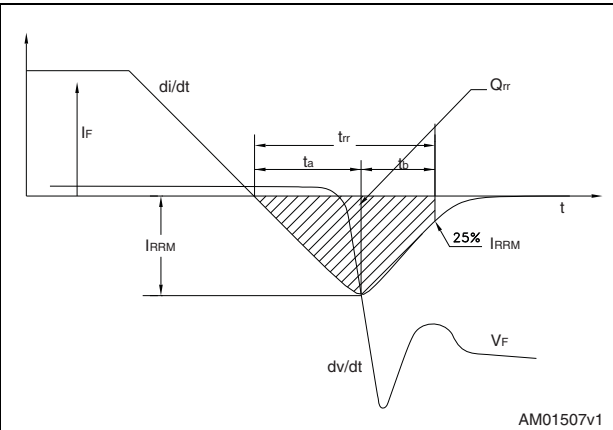

Figure 31. Diode recovery time waveform



STGW80V60DF, STGWT80V60DF

Package mechanical data

4 Package mechanical data

In order to meet environmental requirements, ST offers these devices in different grades of ECOPACK® packages, depending on their level of environmental compliance. ECOPACK® specifications, grade definitions and product status are available at: www.st.com. ECOPACK is an ST trademark.

Figure 32. TO-247 drawing

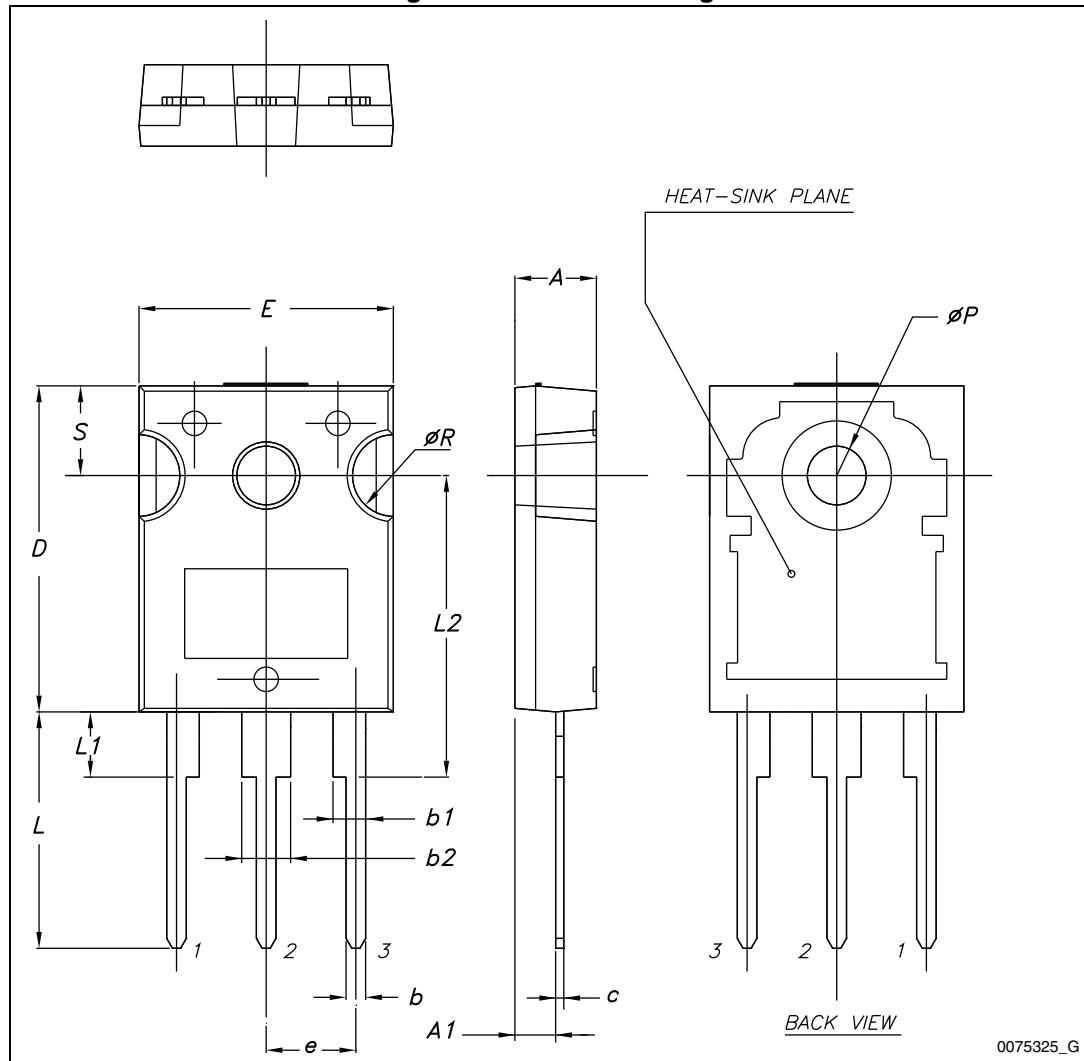

Table 8. TO-247 mechanical data

Dim.	mm.		
	Min.	Typ.	Max.
A	4.85		5.15
A1	2.20		2.60
b	1.0		1.40

Package mechanical data

STGW80V60DF, STGWT80V60DF

Table 8. TO-247 mechanical data

Dim.	mm.		
	Min.	Typ.	Max.
b1	2.0		2.40
b2	3.0		3.40
c	0.40		0.80
D	19.85		20.15
E	15.45		15.75
e	5.30	5.45	5.60
L	14.20		14.80
L1	3.70		4.30
L2		18.50	
ØP	3.55		3.65
ØR	4.50		5.50
S	5.30	5.50	5.70

STGW80V60DF, STGWT80V60DF

Package mechanical data

Figure 33. TO-3P drawing

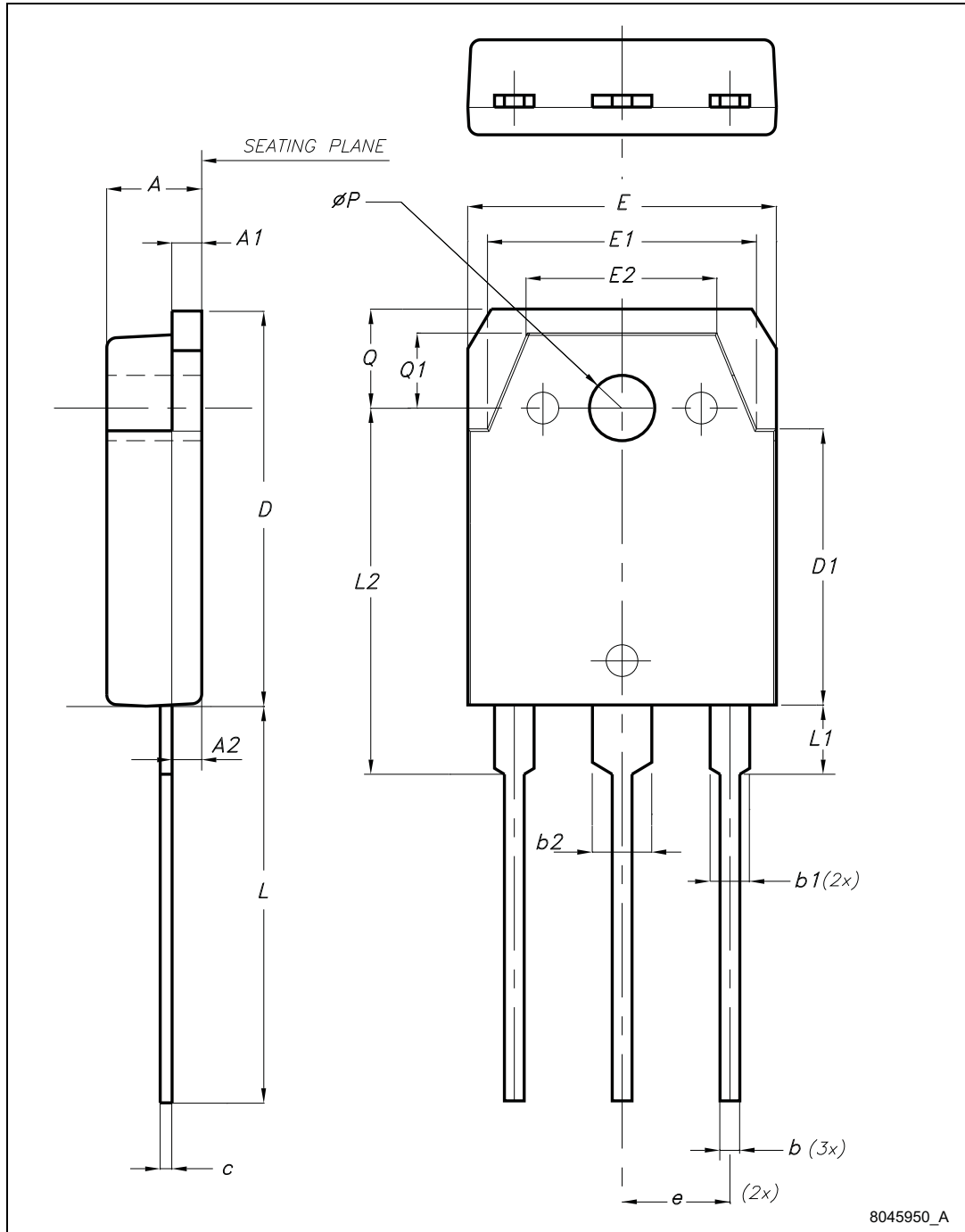

Package mechanical data

STGW80V60DF, STGWT80V60DF

Table 9. TO-3P mechanical data

Dim.	mm		
	Min.	Typ.	Max.
A	4.60		5
A1	1.45	1.50	1.65
A2	1.20	1.40	1.60
b	0.80	1	1.20
b1	1.80		2.20
b2	2.80		3.20
c	0.55	0.60	0.75
D	19.70	19.90	20.10
D1		13.90	
E	15.40		15.80
E1		13.60	
E2		9.60	
e	5.15	5.45	5.75
L	19.50	20	20.50
L1		3.50	
L2	18.20	18.40	18.60
øP	3.10		3.30
Q		5	
Q1		3.80	

5 Revision history

Table 10. Document revision history

Date	Revision	Changes
12-Mar-2013	1	Initial release.
10-Jan-2014	2	Updated title, features and description in cover page. Document status promoted from preliminary to production data. Updated Table 4: Static characteristics , Table 5: Dynamic characteristics , Table 6: IGBT switching characteristics (inductive load) and Table 7: Diode switching characteristics (inductive load) . Inserted Section 2.1: Electrical characteristics (curves) .

STGW80V60DF, STGWT80V60DF

Please Read Carefully:

Information in this document is provided solely in connection with ST products. STMicroelectronics NV and its subsidiaries ("ST") reserve the right to make changes, corrections, modifications or improvements, to this document, and the products and services described herein at any time, without notice.

All ST products are sold pursuant to ST's terms and conditions of sale.

Purchasers are solely responsible for the choice, selection and use of the ST products and services described herein, and ST assumes no liability whatsoever relating to the choice, selection or use of the ST products and services described herein.

No license, express or implied, by estoppel or otherwise, to any intellectual property rights is granted under this document. If any part of this document refers to any third party products or services it shall not be deemed a license grant by ST for the use of such third party products or services, or any intellectual property contained therein or considered as a warranty covering the use in any manner whatsoever of such third party products or services or any intellectual property contained therein.

UNLESS OTHERWISE SET FORTH IN ST'S TERMS AND CONDITIONS OF SALE ST DISCLAIMS ANY EXPRESS OR IMPLIED WARRANTY WITH RESPECT TO THE USE AND/OR SALE OF ST PRODUCTS INCLUDING WITHOUT LIMITATION IMPLIED WARRANTIES OF MERCHANTABILITY, FITNESS FOR A PARTICULAR PURPOSE (AND THEIR EQUIVALENTS UNDER THE LAWS OF ANY JURISDICTION), OR INFRINGEMENT OF ANY PATENT, COPYRIGHT OR OTHER INTELLECTUAL PROPERTY RIGHT.

ST PRODUCTS ARE NOT DESIGNED OR AUTHORIZED FOR USE IN: (A) SAFETY CRITICAL APPLICATIONS SUCH AS LIFE SUPPORTING, ACTIVE IMPLANTED DEVICES OR SYSTEMS WITH PRODUCT FUNCTIONAL SAFETY REQUIREMENTS; (B) AERONAUTIC APPLICATIONS; (C) AUTOMOTIVE APPLICATIONS OR ENVIRONMENTS, AND/OR (D) AEROSPACE APPLICATIONS OR ENVIRONMENTS. WHERE ST PRODUCTS ARE NOT DESIGNED FOR SUCH USE, THE PURCHASER SHALL USE PRODUCTS AT PURCHASER'S SOLE RISK, EVEN IF ST HAS BEEN INFORMED IN WRITING OF SUCH USAGE, UNLESS A PRODUCT IS EXPRESSLY DESIGNATED BY ST AS BEING INTENDED FOR "AUTOMOTIVE, AUTOMOTIVE SAFETY OR MEDICAL" INDUSTRY DOMAINS ACCORDING TO ST PRODUCT DESIGN SPECIFICATIONS. PRODUCTS FORMALLY ESCC, QML OR JAN QUALIFIED ARE DEEMED SUITABLE FOR USE IN AEROSPACE BY THE CORRESPONDING GOVERNMENTAL AGENCY.

Resale of ST products with provisions different from the statements and/or technical features set forth in this document shall immediately void any warranty granted by ST for the ST product or service described herein and shall not create or extend in any manner whatsoever, any liability of ST.

ST and the ST logo are trademarks or registered trademarks of ST in various countries.

Information in this document supersedes and replaces all information previously supplied.

The ST logo is a registered trademark of STMicroelectronics. All other names are the property of their respective owners.

© 2014 STMicroelectronics - All rights reserved

STMicroelectronics group of companies

Australia - Belgium - Brazil - Canada - China - Czech Republic - Finland - France - Germany - Hong Kong - India - Israel - Italy - Japan - Malaysia - Malta - Morocco - Philippines - Singapore - Spain - Sweden - Switzerland - United Kingdom - United States of America

www.st.com