

Excellent Integrated System Limited

Stocking Distributor

Click to view price, real time Inventory, Delivery & Lifecycle Information:

[Central Semiconductor Corp](#)

[CMKD6263 TR](#)

For any questions, you can email us directly:

sales@integrated-circuit.com

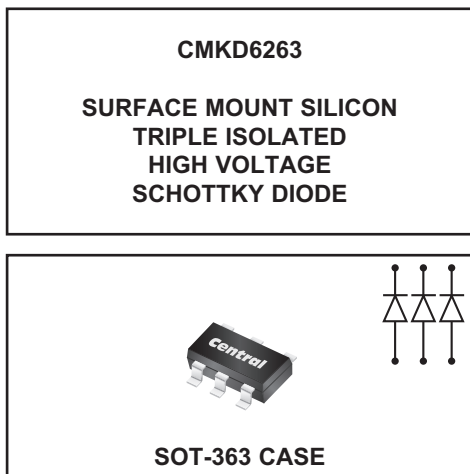

www.centrasemi.com

DESCRIPTION:

The CENTRAL SEMICONDUCTOR CMKD6263 contains three (3) galvanically isolated, high voltage Silicon Schottky diodes, epoxy molded in a SOT-363 surface mount package. This ULTRAmimi™ device has been designed for fast switching applications requiring a low forward voltage drop.

MARKING CODE: K63

FEATURES:

- Meets Galvanic Isolation Requirements of IEEE 1394
- High Voltage (70V)
- Requires less board space than 3 individual diodes
- Low Forward Voltage

MAXIMUM RATINGS: (T_A=25°C)

	SYMBOL		UNITS
Peak Repetitive Reverse Voltage	V _{RRM}	70	V
Continuous Forward Current	I _F	15	mA
Peak Forward Surge Current, tp=1.0s	I _{FSM}	50	mA
Power Dissipation	P _D	250	mW
Operating and Storage Junction Temperature	T _J , T _{stg}	-65 to +150	°C
Thermal Resistance	θ _{JA}	500	°C/W

ELECTRICAL CHARACTERISTICS PER DIODE: (T_A=25°C unless otherwise noted)

SYMBOL	TEST CONDITIONS	MIN	TYP	MAX	UNITS
I _R	V _R =50V		10	200	nA
BV _R	I _R =10μA	70			V
V _F	I _F =1.0mA		395	410	mV
C _J	V _R =0, f=1.0MHz			2.0	pF
t _{rr}	I _R =I _F =10mA, I _{rr} =1.0mA, R _L =100Ω			5.0	ns

CMKD6263
SURFACE MOUNT SILICON
TRIPLE ISOLATED
HIGH VOLTAGE
SCHOTTKY DIODE



SOT-363 CASE - MECHANICAL OUTLINE

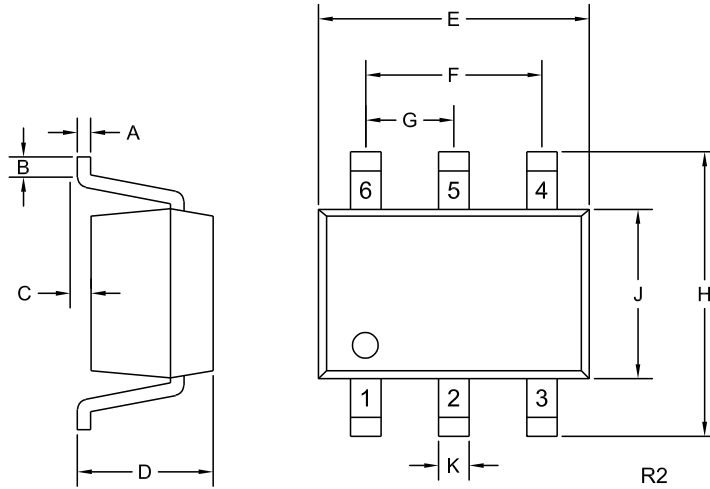

PIN CONFIGURATION

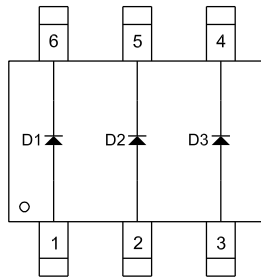

LEAD CODE:

- 1) Anode D1
- 2) Anode D2
- 3) Anode D3
- 4) Cathode D3
- 5) Cathode D2
- 6) Cathode D1

MARKING CODE: K63

SYMBOL	INCHES		MILLIMETERS	
	MIN	MAX	MIN	MAX
A	0.004	0.010	0.10	0.25
B	0.005	-	0.12	-
C	0.000	0.004	0.00	0.10
D	0.031	0.043	0.80	1.10
E	0.071	0.087	1.80	2.20
F	0.051		1.30	
G	0.026		0.65	
H	0.075	0.091	1.90	2.30
J	0.043	0.055	1.10	1.40
K	0.006	0.012	0.15	0.30

SOT-363 (REV: R2)

R5 (11-December 2015)

CMKD6263

**SURFACE MOUNT SILICON
 TRIPLE ISOLATED
 HIGH VOLTAGE
 SCHOTTKY DIODE**



TYPICAL ELECTRICAL CHARACTERISTICS

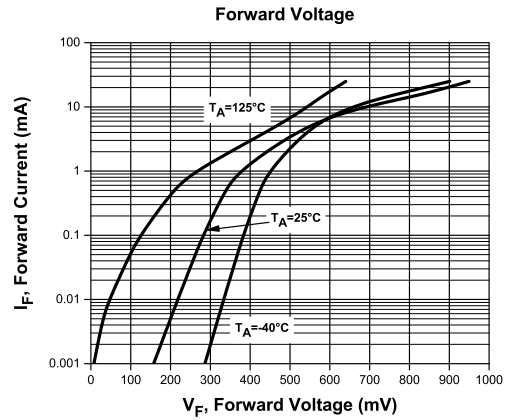
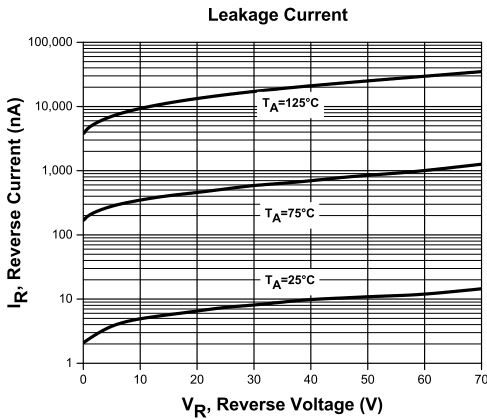

R5 (11-December 2015)

CMKD6263

SURFACE MOUNT SILICON
TRIPLE ISOLATED
HIGH VOLTAGE
SCHOTTKY DIODE



TYPICAL ELECTRICAL CHARACTERISTICS

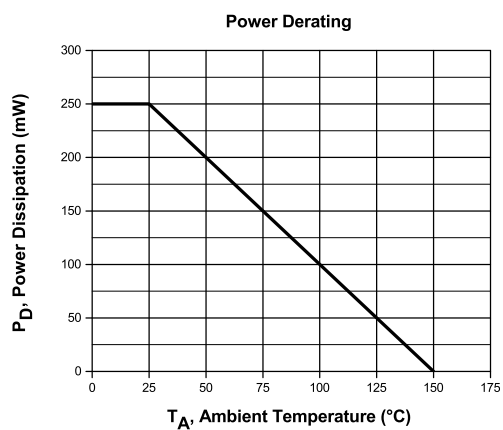
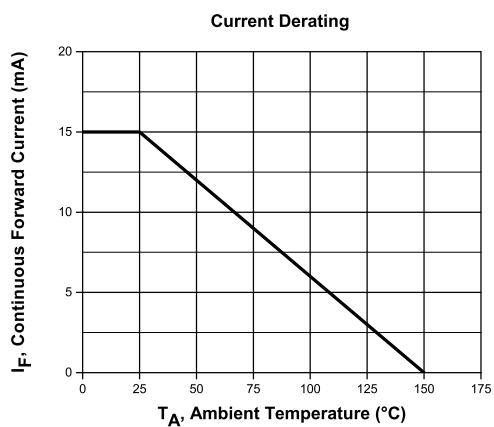

R5 (11-December 2015)

OUTSTANDING SUPPORT AND SUPERIOR SERVICES



PRODUCT SUPPORT

Central's operations team provides the highest level of support to insure product is delivered on-time.

- Supply management (Customer portals)
- Inventory bonding
- Consolidated shipping options
- Custom bar coding for shipments
- Custom product packing

DESIGNER SUPPORT/SERVICES

Central's applications engineering team is ready to discuss your design challenges. Just ask.

- Free quick ship samples (2nd day air)
- Online technical data and parametric search
- SPICE models
- Custom electrical curves
- Environmental regulation compliance
- Customer specific screening
- Up-screening capabilities
- Special wafer diffusions
- PbSn plating options
- Package details
- Application notes
- Application and design sample kits
- Custom product and package development

CONTACT US

Corporate Headquarters & Customer Support Team

Central Semiconductor Corp.
145 Adams Avenue
Hauppauge, NY 11788 USA
Main Tel: (631) 435-1110
Main Fax: (631) 435-1824
Support Team Fax: (631) 435-3388
www.centrasemi.com

Worldwide Field Representatives:
www.centrasemi.com/wwreps

Worldwide Distributors:
www.centrasemi.com/wwdistributors

For the latest version of Central Semiconductor's **LIMITATIONS AND DAMAGES DISCLAIMER**, which is part of Central's Standard Terms and Conditions of sale, visit: www.centrasemi.com/terms