

## Excellent Integrated System Limited

Stocking Distributor

Click to view price, real time Inventory, Delivery & Lifecycle Information:

[Molex Connector Corporation](#)  
[71231-0015](#)

For any questions, you can email us directly:

[sales@integrated-circuit.com](mailto:sales@integrated-circuit.com)

**NOTES:**

- ASSEMBLY NO. 71233-0007 SHOWN FOR ILLUSTRATION.
- MATES WITH PART NO. 71694-\*\*\*\*, AND 5557-\*
- SEE FOLLOWING PAGES FOR PART NOS. & CONFIGURATIONS.
- FINISHES (SEE CHART):  
 TIN OVERALL - .000150/(0.0038) MINIMUM TIN OVERALL, NICKEL UNDERPLATE OVERALL.  
 30 GOLD - .000030/(0.00076) MINIMUM SELECT GOLD AND .000100/(0.00254) MINIMUM SELECT TIN OVER NICKEL UNDERPLATE OVERALL.  
 15 GOLD - .000015/(0.00038) MINIMUM SELECT GOLD AND .000150/(0.0038) MINIMUM SELECT TIN OVER NICKEL UNDERPLATE OVERALL.
- ITEM NO'S PRECEDED BY AN 'X' IN THE CHARTS ARE NOT AVAILABLE.
- HOUSING MATERIAL: HIGH TEMP. 94V-0 GLASS FILLED POLYESTER MATERIAL COLOR: WHITE
- PIN MATERIAL: BRASS.
- PART CONFORMS TO SPECIFICATION NO. PS-71690-001.
- PACKAGING SPECIFICATIONS:  
 FOR TRAY, SEE PK-71232-0000  
 FOR TUBE, SEE PK-71233-0000

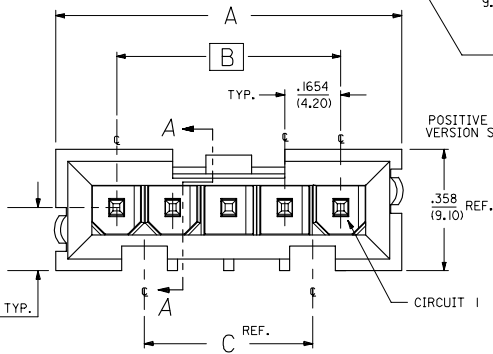
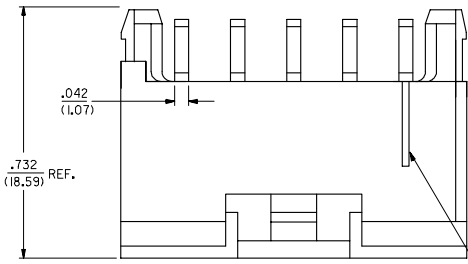
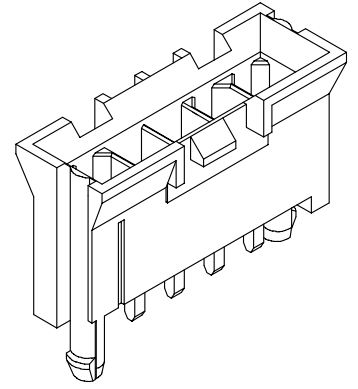

POSITIVE LOCK VERSION SHOWN

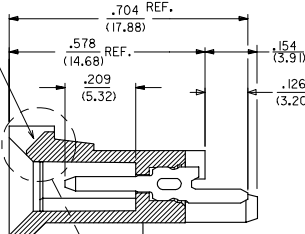

**SECTION A-A**

.126 STANDARD PCB TAIL VERSION

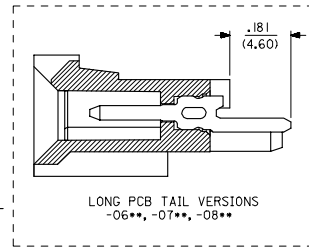

LONG PCB TAIL VERSIONS  
-06\*\*, -07\*\*, -08\*\*

**VERTICAL TAIL HOLE PATTERN**

CONNECTOR SIDE SHOWN

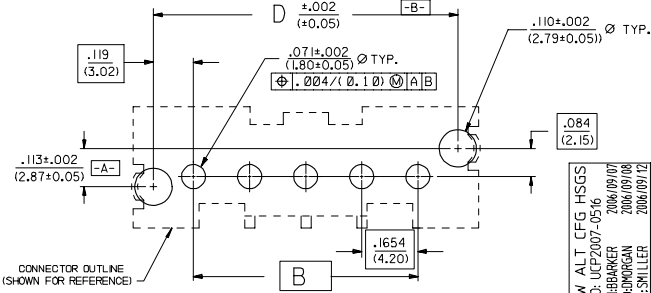

NOTE FOR LEAD FREE CONVERSION:

THE PRIMARY SHIPPING CARTON WILL BE LABELED 'COMPLIANT TO RoHS DIRECTIVE 2002/95/EC AND ELV ANNEX II OF DIRECTIVE 2000/53/EC'. CARTONS WITHOUT THIS LABEL MAY CONTAIN PRODUCT WITH LEAD.

**PASSIVE LOCK OPTION**

SHOW ALT. CFG HSGS IEC NO: UCP2007-0516 DRW: BARKER CHK: KJONGAN APPR: MILLER DATE: 2006/09/07 DATE: 2006/09/08 DATE: 2006/09/12	QUALITY SYMBOLS ▽=0 ▽=0	GENERAL TOLERANCES (UNLESS SPECIFIED)		DIMENSION STYLE IN/MM	SCALE 5:1	DESIGN UNITS INCH	THIRD ANGLE PROJECTION		
		4 PLACES ±.005 ±.005	3 PLACES ±.005 ±.010	2 PLACES ±.038 ±.015	1 PLACE ±.025 ±.015	DRAWN BY RWB DATE 7/19/93	CHECKED BY PAR DATE 7/19/93	APPROVED BY FAH DATE 7/19/93	TITLE SINGLE ROW MINI-FIT HEADER, VERTICAL, THRU-HOLE SALES DWG
		ANGULAR ±1/2°		MATERIAL NO. SEE TABLES	DOCUMENT NO. SDA-71231-****	MOLEX INCORPORATED		SHEET NO. 1 OF 4	
		DRAFT WHERE APPLICABLE MUST REMAIN WITHIN DIMENSIONS							THIS DRAWING CONTAINS INFORMATION THAT IS PROPRIETARY TO MOLEX INCORPORATED AND SHOULD NOT BE USED WITHOUT WRITTEN PERMISSION

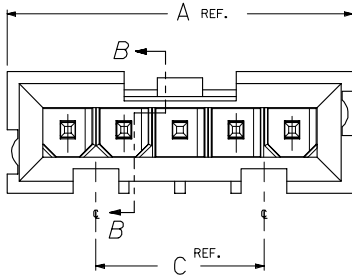

SEE SHEET 1 FOR ALL OTHER INFORMATION

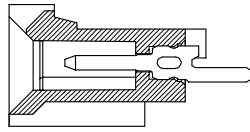

SECTION B-B

**NO PEG OPTION**

VERTICAL CONFIGURATIONS

**OVERALL DIMENSIONS**

**ASSEMBLIES WITH PEGS**

SIZE	DIM. "A"		DIM. "B" BASIC		DIM. "C" REF.		DIM. "D"	
	INCH	(MM)	INCH	(MM)	INCH	(MM)	INCH	(MM)
2	0.524	(13.31)	0.1654	(4.200)	N/A	N/A	.403	(10.24)
3	0.689	(17.51)	0.3307	(8.400)	N/A	N/A	.569	(14.44)
4	0.855	(21.71)	0.4961	(12.600)	0.330	(8.40)	.734	(18.64)
5	1.020	(25.91)	0.6614	(16.800)	0.496	(12.60)	.899	(22.84)
6	1.185	(30.11)	0.8268	(21.000)	0.661	(16.80)	1.064	(27.04)
7	1.351	(34.31)	0.9921	(25.200)	0.826	(21.00)	1.230	(31.24)
8	1.516	(38.51)	1.1575	(29.400)	0.992	(25.20)	1.395	(35.44)
9	1.682	(42.71)	1.3228	(33.600)	1.157	(29.40)	1.561	(39.64)
10	1.847	(46.91)	1.4882	(37.800)	1.322	(33.60)	1.726	(43.84)
11	2.012	(51.11)	1.6535	(42.000)	1.488	(37.80)	1.891	(48.04)
12	2.177	(55.31)	1.8189	(46.200)	1.653	(42.00)	2.057	(52.24)

**ASSEMBLIES WITHOUT PEGS**

SIZE	DIM. "A"		DIM. "B" BASIC		DIM. "C" REF.	
	INCH	(MM)	INCH	(MM)	INCH	(MM)
2	0.524	(13.31)	0.1654	(4.200)	N/A	N/A
3	0.689	(17.51)	0.3307	(8.400)	N/A	N/A
4	0.855	(21.71)	0.4961	(12.600)	0.330	(8.40)
5	1.020	(25.91)	0.6614	(16.800)	0.496	(12.60)
6	1.185	(30.11)	0.8268	(21.000)	0.661	(16.80)
7	1.351	(34.31)	0.9921	(25.200)	0.826	(21.00)
8	1.516	(38.51)	1.1575	(29.400)	0.992	(25.20)
9	1.682	(42.71)	1.3228	(33.600)	1.157	(29.40)
10	1.847	(46.91)	1.4882	(37.800)	1.322	(33.60)
11	2.012	(51.11)	1.6535	(42.000)	1.488	(37.80)
12	2.177	(55.31)	1.8189	(46.200)	1.653	(42.00)

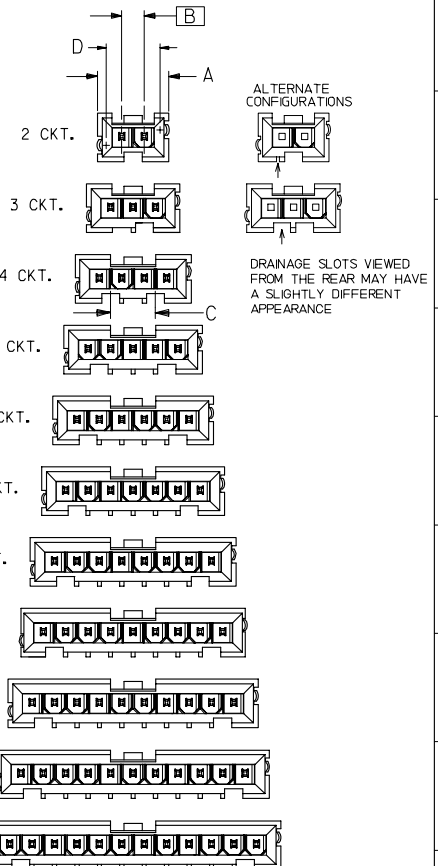

ADD. ALT. CONFIGS ELC NO: UCF2007-0516 DRW: BARKER 2006/09/07 CHK: KUMAR 2006/09/08 APPR: MILLER 2006/09/12 REV: DESCRIPTION	QUALITY SYMBOLS ▽=0 ▽=0	GENERAL TOLERANCES (UNLESS SPECIFIED) <table border="1"> <thead> <tr> <th></th> <th>mm</th> <th>INCH</th> </tr> </thead> <tbody> <tr><td>4 PLACES</td><td>±.005</td><td>±.002</td></tr> <tr><td>3 PLACES</td><td>±.010</td><td>±.004</td></tr> <tr><td>2 PLACES</td><td>±.030</td><td>±.012</td></tr> <tr><td>1 PLACE</td><td>±.075</td><td>±.030</td></tr> </tbody> </table> ANGULAR ±1/2°		mm	INCH	4 PLACES	±.005	±.002	3 PLACES	±.010	±.004	2 PLACES	±.030	±.012	1 PLACE	±.075	±.030	DIMENSION STYLE IN/MM SCALE 5:1 DESIGN UNITS INCH THIRD ANGLE PROJECTION
		mm	INCH															
	4 PLACES	±.005	±.002															
	3 PLACES	±.010	±.004															
2 PLACES	±.030	±.012																
1 PLACE	±.075	±.030																
DRAWN BY: RWB DATE: 7/19/93 CHECKED BY: PAR DATE: 7/19/93 APPROVED BY: FAH DATE: 7/19/93	TITLE: SINGLE ROW MINI-FIT HEADER ASSEMBLY VERTICAL, THRU HOLE MOLEX INCORPORATED																	
DRAFT WHERE APPLICABLE MUST REMAIN WITHIN DIMENSIONS	MATERIAL NO. SEE TABLES DOCUMENT NO. SDA-71231-**** SHEET NO. 2 OF 4																	
THIS DRAWING CONTAINS INFORMATION THAT IS PROPRIETARY TO MOLEX INCORPORATED AND SHOULD NOT BE USED WITHOUT WRITTEN PERMISSION																		

CKT SIZE	ASSEMBLY NUMBER	TAIL VERSION	PEGS	LOCK	PACKAGING PER	PLATING SEE NOTE 4	CKT SIZE	ASSEMBLY NUMBER	TAIL VERSION	PEGS	LOCK	PACKAGING PER	PLATING SEE NOTE 4
J	2	71231-0001	STD. .125	YES	POSITIVE	PK-71232-0000	2	71231-0002	STD. .125	YES	PASSIVE	PK-71232-0000	TIN OVERALL
J	3	71231-0003	STD. .125	YES	POSITIVE	PK-71232-0000	3	71231-0004	STD. .125	YES	PASSIVE	PK-71232-0000	TIN OVERALL
J	4	71231-0005	STD. .125	YES	POSITIVE	PK-71232-0000	4	71231-0006	STD. .125	YES	PASSIVE	PK-71232-0000	TIN OVERALL
J	5	71231-0007	STD. .125	YES	POSITIVE	PK-71232-0000	5	71231-0008	STD. .125	YES	PASSIVE	PK-71232-0000	TIN OVERALL
J	6	71231-0009	STD. .125	YES	POSITIVE	PK-71232-0000	6	71231-0010	STD. .125	YES	PASSIVE	PK-71232-0000	TIN OVERALL
J	7	71231-0011	STD. .125	YES	POSITIVE	PK-71232-0000	7	71231-0012	STD. .125	YES	PASSIVE	PK-71232-0000	TIN OVERALL
J	8	71231-0013	STD. .125	YES	POSITIVE	PK-71232-0000	8	71231-0014	STD. .125	YES	PASSIVE	PK-71232-0000	TIN OVERALL
J	9	71231-0015	STD. .125	YES	POSITIVE	PK-71232-0000	9	71231-0016	STD. .125	YES	PASSIVE	PK-71232-0000	TIN OVERALL
J	10	71231-0017	STD. .125	YES	POSITIVE	PK-71232-0000	10	71231-0018	STD. .125	YES	PASSIVE	PK-71232-0000	TIN OVERALL
J	11	71231-0019	STD. .125	YES	POSITIVE	PK-71232-0000	11	71231-0020	STD. .125	YES	PASSIVE	PK-71232-0000	TIN OVERALL
J	12	71231-0021	STD. .125	YES	POSITIVE	PK-71232-0000	12	71231-0022	STD. .125	YES	PASSIVE	PK-71232-0000	TIN OVERALL
H	2	71231-0101	STD. .125	YES	POSITIVE	PK-71232-0000	2	71231-0102	STD. .125	YES	PASSIVE	PK-71232-0000	30 GOLD
H	3	71231-0103	STD. .125	YES	POSITIVE	PK-71232-0000	3	71231-0104	STD. .125	YES	PASSIVE	PK-71232-0000	30 GOLD
H	4	71231-0105	STD. .125	YES	POSITIVE	PK-71232-0000	4	71231-0106	STD. .125	YES	PASSIVE	PK-71232-0000	30 GOLD
H	5	71231-0107	STD. .125	YES	POSITIVE	PK-71232-0000	5	71231-0108	STD. .125	YES	PASSIVE	PK-71232-0000	30 GOLD
H	6	71231-0109	STD. .125	YES	POSITIVE	PK-71232-0000	6	71231-0110	STD. .125	YES	PASSIVE	PK-71232-0000	30 GOLD
H	7	71231-0111	STD. .125	YES	POSITIVE	PK-71232-0000	7	71231-0112	STD. .125	YES	PASSIVE	PK-71232-0000	30 GOLD
H	8	71231-0113	STD. .125	YES	POSITIVE	PK-71232-0000	8	71231-0114	STD. .125	YES	PASSIVE	PK-71232-0000	30 GOLD
H	9	71231-0115	STD. .125	YES	POSITIVE	PK-71232-0000	9	71231-0116	STD. .125	YES	PASSIVE	PK-71232-0000	30 GOLD
H	10	71231-0117	STD. .125	YES	POSITIVE	PK-71232-0000	10	71231-0118	STD. .125	YES	PASSIVE	PK-71232-0000	30 GOLD
H	11	71231-0119	STD. .125	YES	POSITIVE	PK-71232-0000	11	71231-0120	STD. .125	YES	PASSIVE	PK-71232-0000	30 GOLD
H	12	71231-0121	STD. .125	YES	POSITIVE	PK-71232-0000	12	71231-0122	STD. .125	YES	PASSIVE	PK-71232-0000	30 GOLD
F	2	71231-0201	STD. .125	NO	POSITIVE	PK-71232-0000	2	71231-0202	STD. .125	NO	PASSIVE	PK-71232-0000	TIN OVERALL
F	3	71231-0203	STD. .125	NO	POSITIVE	PK-71232-0000	3	71231-0204	STD. .125	NO	PASSIVE	PK-71232-0000	TIN OVERALL
F	4	71231-0205	STD. .125	NO	POSITIVE	PK-71232-0000	4	71231-0206	STD. .125	NO	PASSIVE	PK-71232-0000	TIN OVERALL
F	5	71231-0207	STD. .125	NO	POSITIVE	PK-71232-0000	5	71231-0208	STD. .125	NO	PASSIVE	PK-71232-0000	TIN OVERALL
F	6	71231-0209	STD. .125	NO	POSITIVE	PK-71232-0000	6	71231-0210	STD. .125	NO	PASSIVE	PK-71232-0000	TIN OVERALL
F	7	71231-0211	STD. .125	NO	POSITIVE	PK-71232-0000	7	71231-0212	STD. .125	NO	PASSIVE	PK-71232-0000	TIN OVERALL
F	8	71231-0213	STD. .125	NO	POSITIVE	PK-71232-0000	8	71231-0214	STD. .125	NO	PASSIVE	PK-71232-0000	TIN OVERALL
F	9	71231-0215	STD. .125	NO	POSITIVE	PK-71232-0000	9	71231-0216	STD. .125	NO	PASSIVE	PK-71232-0000	TIN OVERALL
F	10	71231-0217	STD. .125	NO	POSITIVE	PK-71232-0000	10	71231-0218	STD. .125	NO	PASSIVE	PK-71232-0000	TIN OVERALL
F	11	71231-0219	STD. .125	NO	POSITIVE	PK-71232-0000	11	71231-0220	STD. .125	NO	PASSIVE	PK-71232-0000	TIN OVERALL
F	12	71231-0221	STD. .125	NO	POSITIVE	PK-71232-0000	12	71231-0222	STD. .125	NO	PASSIVE	PK-71232-0000	TIN OVERALL
D	2	71231-0301	STD. .125	NO	POSITIVE	PK-71232-0000	2	71231-0302	STD. .125	NO	PASSIVE	PK-71232-0000	30 GOLD
D	3	71231-0303	STD. .125	NO	POSITIVE	PK-71232-0000	3	71231-0304	STD. .125	NO	PASSIVE	PK-71232-0000	30 GOLD
D	4	71231-0305	STD. .125	NO	POSITIVE	PK-71232-0000	4	71231-0306	STD. .125	NO	PASSIVE	PK-71232-0000	30 GOLD
D	5	71231-0307	STD. .125	NO	POSITIVE	PK-71232-0000	5	71231-0308	STD. .125	NO	PASSIVE	PK-71232-0000	30 GOLD
D	6	71231-0309	STD. .125	NO	POSITIVE	PK-71232-0000	6	71231-0310	STD. .125	NO	PASSIVE	PK-71232-0000	30 GOLD
D	7	71231-0311	STD. .125	NO	POSITIVE	PK-71232-0000	7	71231-0312	STD. .125	NO	PASSIVE	PK-71232-0000	30 GOLD
D	8	71231-0313	STD. .125	NO	POSITIVE	PK-71232-0000	8	71231-0314	STD. .125	NO	PASSIVE	PK-71232-0000	30 GOLD
D	9	71231-0315	STD. .125	NO	POSITIVE	PK-71232-0000	9	71231-0316	STD. .125	NO	PASSIVE	PK-71232-0000	30 GOLD
D	10	71231-0317	STD. .125	NO	POSITIVE	PK-71232-0000	10	71231-0318	STD. .125	NO	PASSIVE	PK-71232-0000	30 GOLD
D	11	71231-0319	STD. .125	NO	POSITIVE	PK-71232-0000	11	71231-0320	STD. .125	NO	PASSIVE	PK-71232-0000	30 GOLD
D	12	71231-0321	STD. .125	NO	POSITIVE	PK-71232-0000	12	71231-0322	STD. .125	NO	PASSIVE	PK-71232-0000	30 GOLD

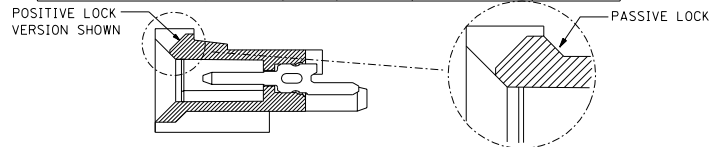

I SEE SHEET I		DIMENSIONS SHOWN (METRIC) INCH		REVISE ONLY ON CAD SYSTEM	
H SEE SHEET I		UNLESS OTHERWISE SPECIFIED TOLERANCES: MILLIMETER ± .125		TITLE SINGLE ROW MINI-FIT HEADER VERTICAL THRU-HOLE BLIND MATE SALES ASSEMBLY	
G SEE SHEET I		INCH METRIC		MOLEX INCORPORATED SHEET NO. 3 DATE 08/02/93	
F SEE SHEET I		1 PLACE ± .005 2 --- 2 ---		PART NO. SDA-71231-***	
E SEE SHEET I		2 PLACE ± .005 2 --- 2 ---		DRAWING NO. 71231-0015	
L SEE SHEET I		3 PLACE ± .005 2 --- 2 ---		DRAWING DATE 08/02/93	
K SEE SHEET I		DRAWING DATE 08/02/93		DRAWING BY FAH	
J SEE SHEET I		DRAWING BY RWB		DRAWING CHECKED BY PAR	
I SEE SHEET I		DRAWING CHECKED BY RWB		DRAWING APPROVED BY FAH	
H SEE SHEET I		DRAWING APPROVED BY FAH		DRAWING SCALE 1:1	
G SEE SHEET I		DRAWING SCALE 1:1		DRAWING FILE NAME ST1231P3.DWG	
F SEE SHEET I		DRAWING FILE NAME ST1231P3.DWG		DRAWING TOLERANCE CLASS TC	