

Excellent Integrated System Limited

Stocking Distributor

Click to view price, real time Inventory, Delivery & Lifecycle Information:

[Analog Devices Inc.](#)
[HMC292LM3C](#)

For any questions, you can email us directly:

sales@integrated-circuit.com



v01.0505



HMC292LM3C

GaAs MMIC DOUBLE-BALANCED SMT MIXER, 17 - 31 GHz

Typical Applications

The HMC292LM3C is ideal for:

- Microwave Point-to-Point Radios
- Multi-Point/LMDS Radios
- SATCOM

Features

- Input IP3: +19 dBm
- LO / RF Isolation: 25 to 40 dB
- Passive: No DC Bias Required
- Leadless SMT Package, 25 mm²

Functional Diagram

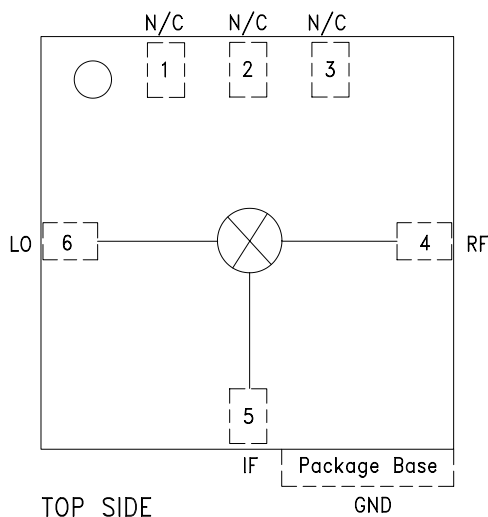

General Description

The HMC292LM3C is a 17 - 31 GHz surface mount passive GaAs MMIC double-balanced mixer in a SMT leadless chip carrier package. The mixer can be used as a downconverter or upconverter. Excellent isolations are provided by on-chip baluns, which require no external components and no DC bias. All data is with the non-hermetic, epoxy sealed LM3C packaged device mounted in a 50 Ohm test fixture. Utilizing the HMC292LM3C eliminates the need for wirebonding, thereby providing a consistent connection interface for the customer.

Electrical Specifications, $T_A = +25^\circ \text{C}$

Parameter	LO= +13 dBm, IF= 1 GHz			LO= +13 dBm, IF= 1 GHz			Units
	Min.	Typ.	Max.	Min.	Typ.	Max.	
Frequency Range, RF & LO	18 - 28			17 - 31			GHz
Frequency Range, IF	DC - 6			DC - 6			GHz
Conversion Loss		7.5	9.5		8	11	dB
Noise Figure (SSB)		7.5	9.5		8	11	dB
LO to RF Isolation	26	35		21	32		dB
LO to IF Isolation	20	25		20	25		dB
RF to IF Isolation	22	33		20	30		dB
IP3 (Input)	17	19		15	19		dBm
IP2 (Input)	45	50		42	50		dBm
1 dB Gain Compression (Input)	8	12		8	12		dBm



v01.0505



HMC292LM3C

GaAs MMIC DOUBLE-BALANCED SMT MIXER, 17 - 31 GHz

Conversion Gain vs. Temperature @ LO = +13 dBm

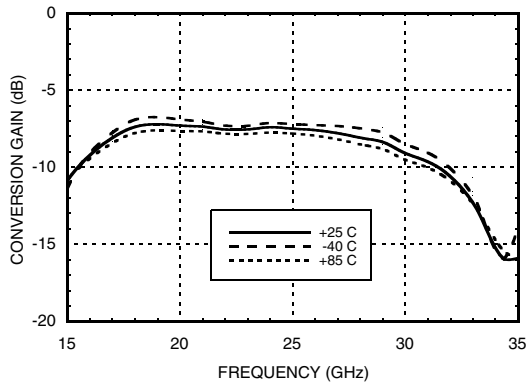

Isolation @ LO = +13 dBm

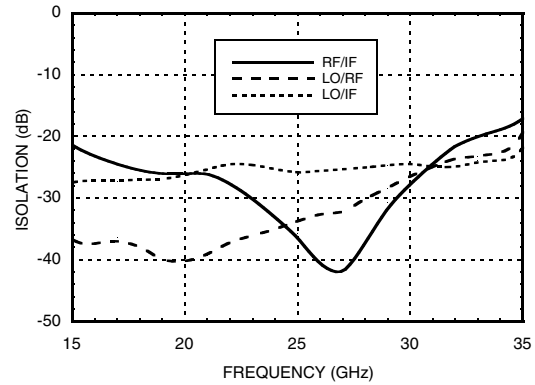

Conversion Gain vs. LO Drive

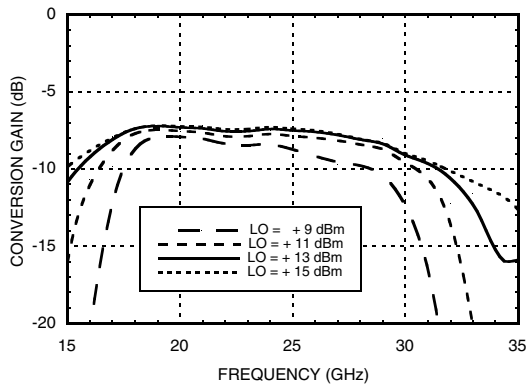

RF & LO Return Loss @ LO = +13 dBm

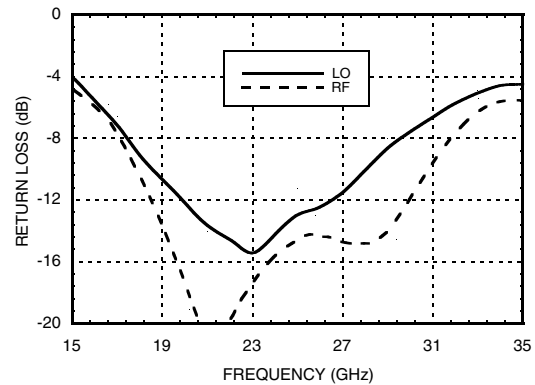

IF Bandwidth @ LO = +13 dBm

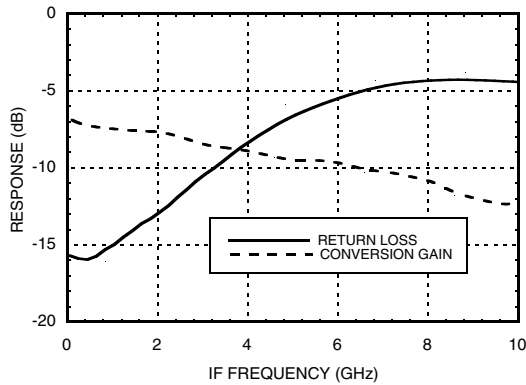

Upconverter Performance Conversion Gain @ LO = +13 dBm

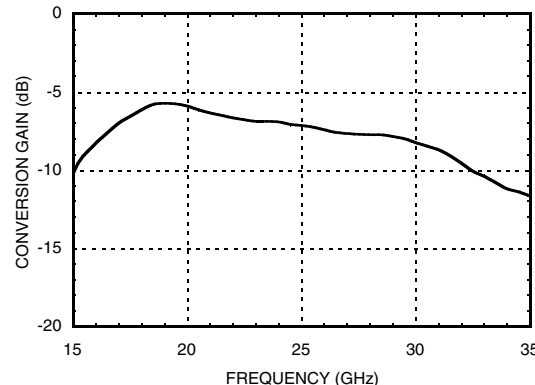

10

MIXERS - SINGLE & DOUBLE BALANCED - SMT



v01.0505



HMC292LM3C

GaAs MMIC DOUBLE-BALANCED SMT MIXER, 17 - 31 GHz

Input IP3 vs. LO Drive

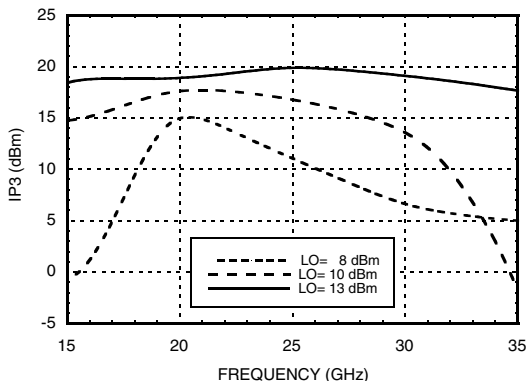

Input IP3 vs. Temperature @ LO = +13 dBm

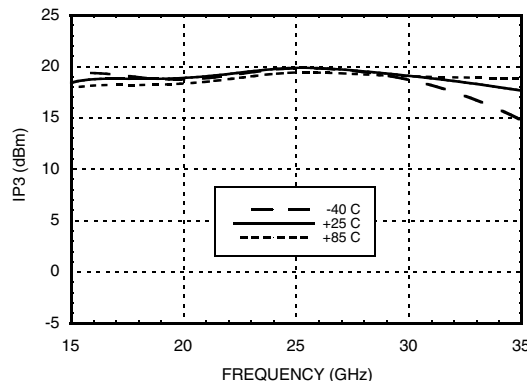

Input IP2 vs. LO Drive

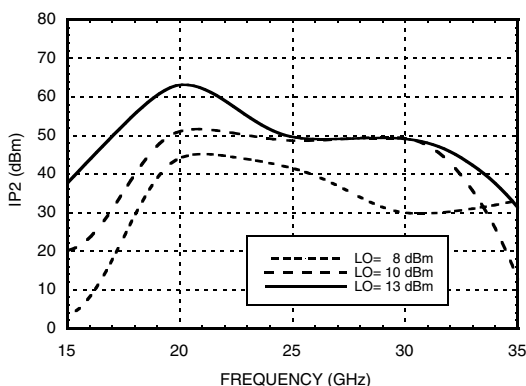

Input IP2 vs. Temperature @ LO = +13 dBm

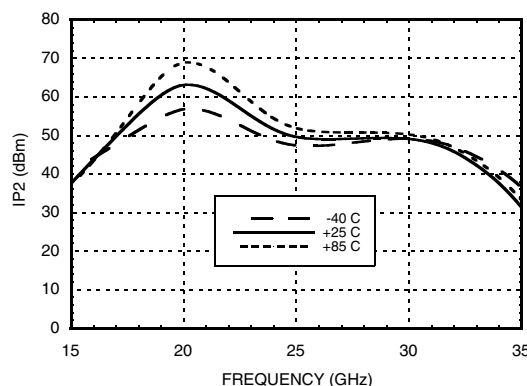

Input P1dB vs. Temperature @ LO = +13 dBm

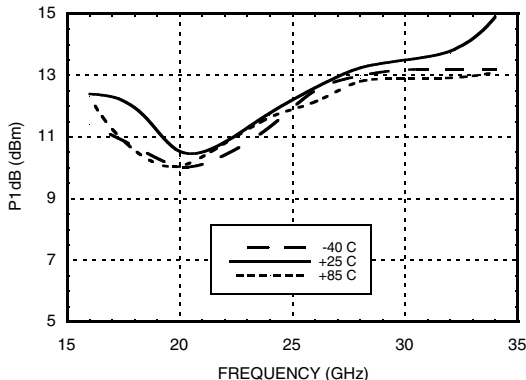

MxN Spurious Outputs

mRF	nLO				
	0	1	2	3	4
0	xx	11			
1	17	0	39		
2		70	77	76	
3			93	69	86
4			>110	>110	>110

RF= 21 GHz @ -10 dBm
 LO= 22 GHz @ +13 dBm
 All values in dBc below the 1F power level.



v01.0505

HMC292LM3C

GaAs MMIC DOUBLE-BALANCED SMT MIXER, 17 - 31 GHz



Absolute Maximum Ratings

RF / IF Input	+13 dBm
LO Drive	+27 dBm
Storage Temperature	-65 to +150 °C
Operating Temperature	-40 to +85 °C
ESD Sensitivity (HBM)	Class 1C



**ELECTROSTATIC SENSITIVE DEVICE
OBSERVE HANDLING PRECAUTIONS**

10

Outline Drawing

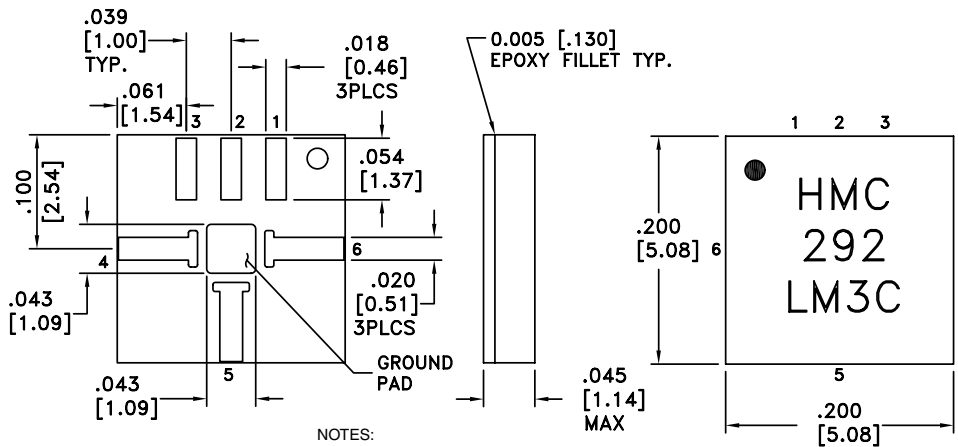

NOTES:

1. MATERIAL: PLASTIC
2. PLATING: GOLD OVER NICKEL
3. DIMENSIONS ARE IN INCHES [MILLIMETERS].
4. ALL TOLERANCES ARE ± 0.005 [± 0.13].
5. ALL GROUNDS MUST BE SOLDERED TO PCB RF GROUND.
6. ● INDICATES PIN 1

Pin Descriptions

Pin Number	Function	Description	Interface Schematic
1, 2, 3	N/C	This pin may be connected to the housing ground or left unconnected.	
4	RF	This pin is DC coupled and matched to 50 Ohm from 18 - 31 GHz	
5	IF	This pin is DC coupled. For applications not requiring operation to DC, this port should be DC blocked externally using a series capacitor whose value has been chosen to pass the necessary IF frequency range. For operation to DC, this pin must not source/sink more than 2 mA of current or die non-function and possible die failure will result.	
6	LO	This pin is DC coupled and matched to 50 Ohm from 18 - 31 GHz.	
	GND	Package base must be soldered to PCB RF ground.	



v01.0505

HMC292LM3C

GaAs MMIC DOUBLE-BALANCED SMT MIXER, 17 - 31 GHz



Evaluation PCB

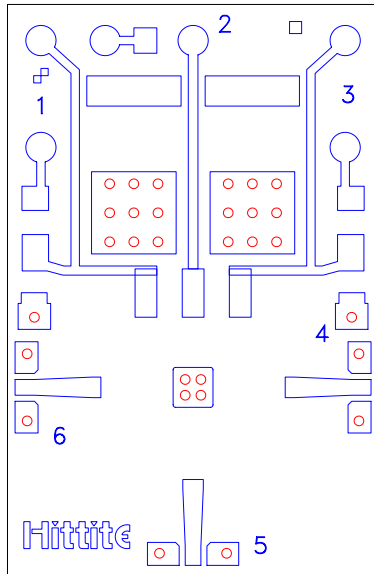

The grounded Co-Planar Wave Guide (CPWG) PCB input/output transitions allow use of Ground-Signal-Ground (GSG) probes for testing. Suggested probe pitch is 400 μ m (16 mils). Alternatively, the board can be mounted in a metal housing with 2.4 mm coaxial connectors.

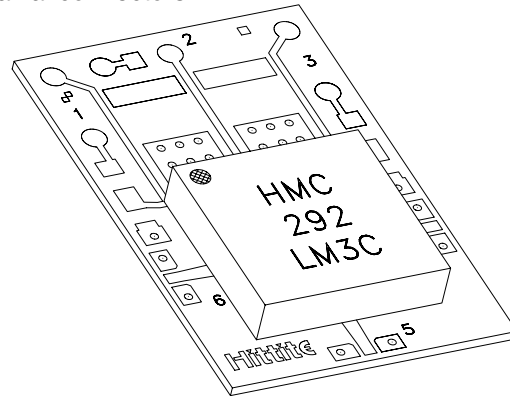

LM3 package mounted to evaluation PCB

Evaluation Circuit Board Layout Design Details

Layout Technique	Micro Strip to CPWG
Material	Rogers 4003 with 1/2 oz. Cu
Dielectric Thickness	0.008" (0.20 mm)
Microstrip Line Width	0.018" (0.46 mm)
CPWG Line Width	0.016" (0.41 mm)
CPWG Line to GND Gap	0.005" (0.13 mm)
Ground Via Hole Diameter	0.008" (0.20 mm)

Suggested LM3-C PCB Land Pattern Tolerance: $\pm 0.003"$ (± 0.08 mm)

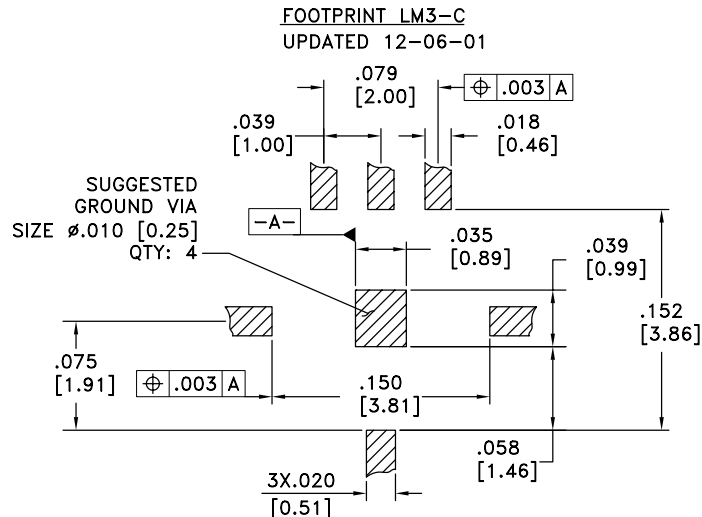



v01.0505



HMC292LM3C

GaAs MMIC DOUBLE-BALANCED SMT MIXER, 17 - 31 GHz

HMC292LM3C Recommended SMT Attachment Technique

Preparation & Handling of the LM3-C Millimeterwave Package for Surface Mounting

The HMC LM3-C package was designed to be compatible with high volume surface mount PCB assembly processes. The LM3-C package requires a specific mounting pattern to allow proper mechanical attachment and to optimize electrical performance at millimeterwave frequencies. This PCB layout pattern can be found on each LM3-C product data sheet. It can also be provided as an electronic drawing upon request from Hittite Sales & Application Engineering.

Follow these precautions to avoid permanent damage:

Cleanliness: Observe proper handling procedures to ensure clean devices and PCBs. LM3-C devices should remain in their original packaging until component placement to ensure no contamination or damage to RF, DC & ground contact areas.

Static Sensitivity: Follow ESD precautions to protect against ESD strikes.

General Handling: Handle the LM3-C package on the top with a vacuum collet or along the edges with a sharp pair of bent tweezers. Avoiding damaging the RF, DC, & ground contacts on the package bottom. Do not apply excess pressure to the top of the lid.

Solder Materials & Temperature Profile: Follow the information contained in the application note. Hand soldering is not recommended. Conductive epoxy attachment is not recommended.

Solder Paste

Solder paste should be selected based on the user's experience and be compatible with the metallization systems used. See the LM3-C data sheet Outline drawing for pin & ground contact metallization schemes.

Solder Paste Application

Solder paste is generally applied to the PCB using either a stencil printer or dot placement. The volume of solder paste will be dependent on PCB and component layout and should be controlled to ensure consistent mechanical & electrical performance. Excess solder may create unwanted electrical parasitics at high frequencies.

Solder Reflow

The soldering process is usually accomplished in a reflow oven but may also use a vapor phase process. A solder reflow profile is suggested above.

Prior to reflowing product, temperature profiles should be measured using the same mass as the actual assemblies. The thermocouple should be moved to various positions on the board to account for edge and corner effects and varying component masses. The final profile should be determined by mounting the thermocouple to the PCB at the location of the device.

Follow solder paste and oven vendor's recommendations when developing a solder reflow profile. A standard profile will have a steady ramp up from room temperature to the pre-heat temperature to avoid damage due to thermal shock. Allow enough time between reaching pre-heat temperature and reflow for the solvent in the paste to evaporate and the flux to completely activate. Reflow must then occur prior to the flux being completely driven off. The duration of peak reflow temperature should not exceed 15 seconds. Packages have been qualified to withstand a peak temperature of 235°C for 15 seconds. Verify that the profile will not expose device to temperatures in excess of 235°C.

Cleaning

A water-based flux wash may be used.

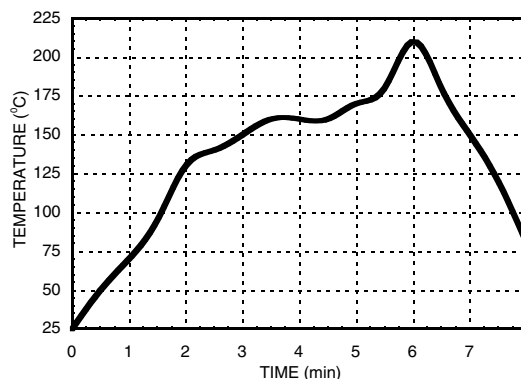

10

MIXERS - SINGLE & DOUBLE BALANCED - SMT