

Excellent Integrated System Limited

Stocking Distributor

Click to view price, real time Inventory, Delivery & Lifecycle Information:

[Triad Magnetics](#)

[F8-48](#)

For any questions, you can email us directly:

sales@integrated-circuit.com



**Power Transformer
Chassis Mount: Quick Pack**

F8-48

Description:

The F8-48 Quick Pack small power transformer offers a significant reduction in size and weight over a standard transformer. This transformer can be used for a wide variety of applications. It is bobbin wound for reduced size and small operating space.

Electrical Specifications (@25C):

Maximum Power: 100.0VA

Input Voltage: 115VAC@50/60Hz

Output Voltage: 48.0VCT@2.0A

Hipot: 2500VAC primary to secondary; 1500VAC windings to core.

Construction:

Split bobbin non concentric winding eliminates costly electrostatic shielding. Termination is suitable for quick connects or soldering. Built with UL Class B Insulation System.

Safety:

UL: File E53148, UL 5085-1 and 2 (formerly UL 506), General Purpose.



Dimensions:

A	B	C	D	E	F	G
2.562	3.562	4.031	2.250	3.062	.187 Dia	1.312

- Notes:** 1. Units: inches.
2. Terminal size: .187" X 0.021".
3. Weight: 2.75 lbs

Schematic:

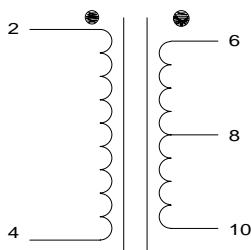

Input: 2 to 4
Output: 6 to 10

RoHS Compliance: As of manufacturing date February 2005, all standard products meet the requirements of 2011/65/EU, known as the RoHS initiative.

* Upon printing, this document is considered "uncontrolled". Please contact Triad Magnetics' website for the most current version.

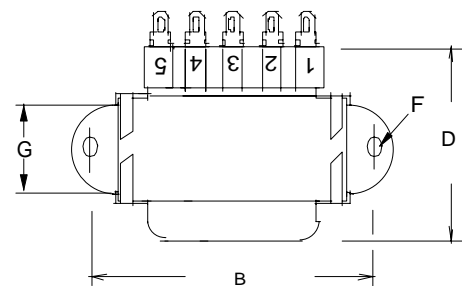
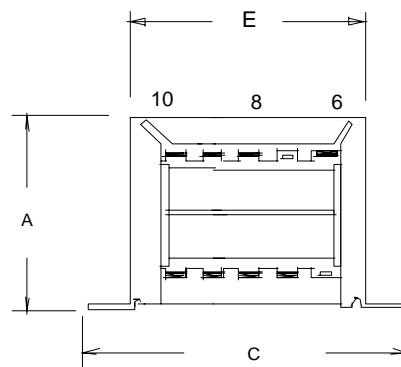
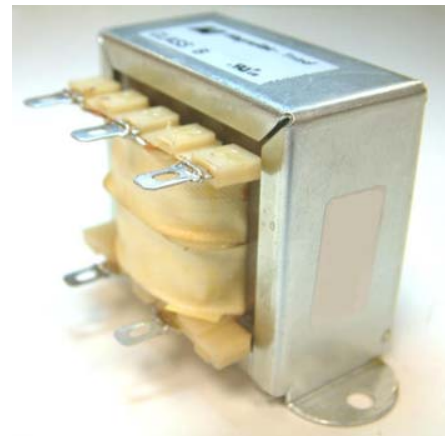

Web: www.TriadMagnetics.com
Phone 951-277-0757
Fax 951-277-2757

460 Harley Knox Blvd.
Perris, California 92571

Publish Date: December 4, 2013