

Excellent Integrated System Limited

Stocking Distributor

Click to view price, real time Inventory, Delivery & Lifecycle Information:

[Weidmüller](#)
[1637240000](#)

For any questions, you can email us directly:

sales@integrated-circuit.com

Product catalogue | PCB connection systems | PCB plug-in connectors | Pitch 5.00 / 5.08 mm (0.197 / 0.200 inch) | Socket connectors, tension clamp connection, pitch 5.00/5.08 | BLZ 5.00-5.08/90/270 | BLZ 5.00/90B

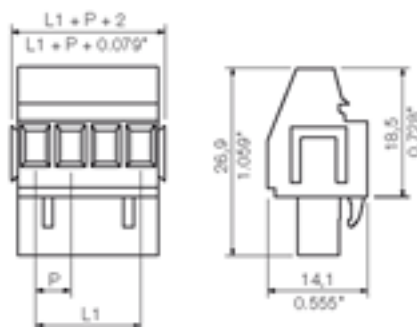
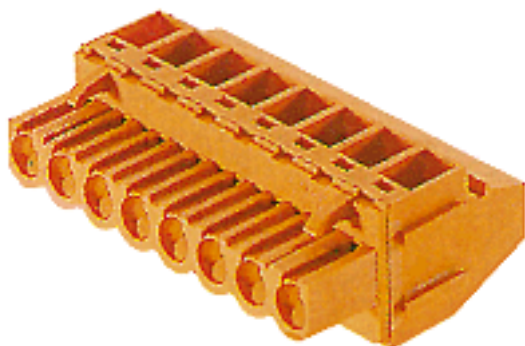
General ordering data

Order No.	1637240000
Part designation	BLZ 5.00/14/90B SN OR
Version	PCB plug-in connector, Female connectors, Clamping yoke connection, Clamping range, max.: 3.31 mm ² , Pitch: 5.00 mm, No. of poles: 14, 90°, Box
EAN	4008190274481
Qty.	24 pc(s).

System parameters

Conductor connection system	Clamping yoke connection
Outgoing direction of conductor	90°
Pitch	5 mm
Pitch in inch	0.197 inch
No. of poles	14
No. of rows	1
Screwdriver blade	0.6 x 3.5
Screwdriver blade standard	DIN 5264
Tightening torque, min.	0.4 Nm
Tightening torque, max.	0.5 Nm
Clamping screw	M 2.5
Stripping length	7 mm
L1 in mm	65 mm
L1 in inch	2.559 inch
Electric shock protection to DIN VDE 0470	IP 20
Electric shock protection to DIN VDE 0470	Safe from finger touch

Material data

Insulating material	PBT
Colour	orange
colour chart	Similar to RAL 2000
Insulating material group	IIIa
Flammability class UL 94	V-0
CTI	>= 200

Product catalogue | PCB connection systems | PCB plug-in connectors | Pitch 5.00 / 5.08 mm (0.197 / 0.200 inch) | Socket connectors, tension clamp connection, pitch 5.00/5.08 | BLZ 5.00-5.08/90/270 | BLZ 5.00/90B

Material data

Contact base material	Copper alloy
Contact surface	tinned

Connectable conductors

Clamping range, min.	0.13 mm ²
Clamping range, max.	3.31 mm ²
AWG, min.	26
AWG, max.	12
Solid, min. H05(07) V-U	0.5 mm ²
Solid, max. H05(07) V-U	2.5 mm ²
Flexible, min. H05(07) V-K	0.5 mm ²
Flexible, max. H05(07) V-K	2.5 mm ²
With wire end ferrule, acc. to DIN 46 228/1, min.	0.5 mm ²
With wire end ferrule, acc. to DIN 46 228/1, max.	2.5 mm ²
w. plastic collar ferrule, DIN 46228 pt 4, min.	0.5 mm ²
w. plastic collar ferrule, DIN 46228 pt 4, max.	2.5 mm ²
Gauge to EN 60999 a x b; ø	2.8 mm x 2.0 mm; 2.4 mm

DIN IEC rating data

Rated current, min. No. pins (Tu=20°C)	15 A
Rated current, max. No. pins (Tu=20°C)	12 A
Rated current, min. No. pins (Tu=40°C)	12 A
Rated current, max. No. pins (Tu=40°C)	10 A
Rated voltage for overvoltage class/pollution severity II/2	400 V
Rated voltage for overvoltage class/pollution severity III/2	320 V
Rated voltage for overvoltage class/pollution severity III/3	250 V
Rated impulse withstand voltage for overvoltage class/pollution severity II/2	4 kV
Rated impulse withstand voltage for overvoltage class/pollution severity III/2	4 kV
Rated impulse withstand voltage for overvoltage class/pollution severity III/3	4 kV
Short-time withstand current resistance	3 x 1s with 120 A

CSA rating data

Rated voltage (Use group D)	300 V
Rated current (Use group D)	10 A
AWG conductor (field wiring), min.	26
AWG conductor (field wiring), max.	12

UL 1059 rating data

Rated voltage (Use group D)	300 V
Rated current (Use group D)	10 A
AWG conductor, min.	26
AWG conductor, max.	12

Product catalogue | PCB connection systems | PCB plug-in connectors | Pitch 5.00 / 5.08 mm (0.197 / 0.200 inch) | Socket connectors, tension clamp connection, pitch 5.00/5.08 | BLZ 5.00-5.08/90/270 | BLZ 5.00/90B

Approvals

Approvals institutes



Classifications

ETIM 2.0	NK
ETIM 3.0	EC001284
eClass 4.1	27-26-07-01
eClass 5.0	27-26-07-01
eClass 5.1	27-26-07-04

Similar products

Order No.	Part designation	Version
1637120000	BLZ 5.00/2/90B SN OR	PCB plug-in connector, Female connectors, Clamping yoke connection, Clamping range, max.: 3.31 mm ² , Pitch: 5.00 mm, No. of poles: 2, 90°, Box
1637350000	BLZ 5.00/2/90B SN SW	PCB plug-in connector, Female connectors, Clamping yoke connection, Clamping range, max.: 3.31 mm ² , Pitch: 5.00 mm, No. of poles: 2, 90°, Box
1637130000	BLZ 5.00/3/90B SN OR	PCB plug-in connector, Female connectors, Clamping yoke connection, Clamping range, max.: 3.31 mm ² , Pitch: 5.00 mm, No. of poles: 3, 90°, Box
1637360000	BLZ 5.00/3/90B SN SW	PCB plug-in connector, Female connectors, Clamping yoke connection, Clamping range, max.: 3.31 mm ² , Pitch: 5.00 mm, No. of poles: 3, 90°, Box
1637140000	BLZ 5.00/4/90B SN OR	PCB plug-in connector, Female connectors, Clamping yoke connection, Clamping range, max.: 3.31 mm ² , Pitch: 5.00 mm, No. of poles: 4, 90°, Box
1637370000	BLZ 5.00/4/90B SN SW	PCB plug-in connector, Female connectors, Clamping yoke connection, Clamping range, max.: 3.31 mm ² , Pitch: 5.00 mm, No. of poles: 4, 90°, Box
1637150000	BLZ 5.00/5/90B SN OR	PCB plug-in connector, Female connectors, Clamping yoke connection, Clamping range, max.: 3.31 mm ² , Pitch: 5.00 mm, No. of poles: 5, 90°, Box
1637380000	BLZ 5.00/5/90B SN SW	PCB plug-in connector, Female connectors, Clamping yoke connection, Clamping range, max.: 3.31 mm ² , Pitch: 5.00 mm, No. of poles: 5, 90°, Box
1637160000	BLZ 5.00/6/90B SN OR	PCB plug-in connector, Female connectors, Clamping yoke connection, Clamping range, max.: 3.31 mm ² , Pitch: 5.00 mm, No. of poles: 6, 90°, Box
1637170000	BLZ 5.00/7/90B SN OR	PCB plug-in connector, Female connectors, Clamping yoke connection, Clamping range, max.: 3.31 mm ² , Pitch: 5.00 mm, No. of poles: 7, 90°, Box
1637180000	BLZ 5.00/8/90B SN OR	PCB plug-in connector, Female connectors, Clamping yoke connection, Clamping range, max.: 3.31 mm ² , Pitch: 5.00 mm, No. of poles: 8, 90°, Box

Product catalogue | PCB connection systems | PCB plug-in connectors | Pitch 5.00 / 5.08 mm (0.197 / 0.200 inch) | Socket connectors, tension clamp connection, pitch 5.00/5.08 | BLZ 5.00-5.08/90/270 | BLZ 5.00/90B

1637410000	BLZ 5.00/8/90B SN SW	PCB plug-in connector, Female connectors, Clamping yoke connection, Clamping range, max.: 3.31 mm ² , Pitch: 5.00 mm, No. of poles: 8, 90°, Box
1637190000	BLZ 5.00/9/90B SN OR	PCB plug-in connector, Female connectors, Clamping yoke connection, Clamping range, max.: 3.31 mm ² , Pitch: 5.00 mm, No. of poles: 9, 90°, Box
1637420000	BLZ 5.00/9/90B SN SW	PCB plug-in connector, Female connectors, Clamping yoke connection, Clamping range, max.: 3.31 mm ² , Pitch: 5.00 mm, No. of poles: 9, 90°, Box
1637200000	BLZ 5.00/10/90B SN OR	PCB plug-in connector, Female connectors, Clamping yoke connection, Clamping range, max.: 3.31 mm ² , Pitch: 5.00 mm, No. of poles: 10, 90°, Box
1637430000	BLZ 5.00/10/90B SN SW	PCB plug-in connector, Female connectors, Clamping yoke connection, Clamping range, max.: 3.31 mm ² , Pitch: 5.00 mm, No. of poles: 10, 90°, Box
1637210000	BLZ 5.00/11/90B SN OR	PCB plug-in connector, Female connectors, Clamping yoke connection, Clamping range, max.: 3.31 mm ² , Pitch: 5.00 mm, No. of poles: 11, 90°, Box
1637440000	BLZ 5.00/11/90B SN SW	PCB plug-in connector, Female connectors, Clamping yoke connection, Clamping range, max.: 3.31 mm ² , Pitch: 5.00 mm, No. of poles: 11, 90°, Box
1637220000	BLZ 5.00/12/90B SN OR	PCB plug-in connector, Female connectors, Clamping yoke connection, Clamping range, max.: 3.31 mm ² , Pitch: 5.00 mm, No. of poles: 12, 90°, Box
1637450000	BLZ 5.00/12/90B SN SW	PCB plug-in connector, Female connectors, Clamping yoke connection, Clamping range, max.: 3.31 mm ² , Pitch: 5.00 mm, No. of poles: 12, 90°, Box
1637230000	BLZ 5.00/13/90B SN OR	PCB plug-in connector, Female connectors, Clamping yoke connection, Clamping range, max.: 3.31 mm ² , Pitch: 5.00 mm, No. of poles: 13, 90°, Box
1637250000	BLZ 5.00/15/90B SN OR	PCB plug-in connector, Female connectors, Clamping yoke connection, Clamping range, max.: 3.31 mm ² , Pitch: 5.00 mm, No. of poles: 15, 90°, Box
1637260000	BLZ 5.00/16/90B SN OR	PCB plug-in connector, Female connectors, Clamping yoke connection, Clamping range, max.: 3.31 mm ² , Pitch: 5.00 mm, No. of poles: 16, 90°, Box
1637270000	BLZ 5.00/17/90B SN OR	PCB plug-in connector, Female connectors, Clamping yoke connection, Clamping range, max.: 3.31 mm ² , Pitch: 5.00 mm, No. of poles: 17, 90°, Box
1637280000	BLZ 5.00/18/90B SN OR	PCB plug-in connector, Female connectors, Clamping yoke connection, Clamping range, max.: 3.31 mm ² , Pitch: 5.00 mm, No. of poles: 18, 90°, Box
1637290000	BLZ 5.00/19/90B SN OR	PCB plug-in connector, Female connectors, Clamping yoke connection, Clamping range, max.: 3.31 mm ² , Pitch: 5.00 mm, No. of poles: 19, 90°, Box
1637300000	BLZ 5.00/20/90B SN OR	PCB plug-in connector, Female connectors, Clamping yoke connection, Clamping range, max.: 3.31 mm ² , Pitch: 5.00 mm, No. of poles: 20, 90°, Box
1637530000	BLZ 5.00/20/90B SN SW	PCB plug-in connector, Female connectors, Clamping yoke connection, Clamping range, max.: 3.31 mm ² , Pitch: 5.00 mm, No. of poles: 20, 90°, Box

1637310000	BLZ 5.00/21/90B SN OR	PCB plug-in connector, Female connectors, Clamping yoke connection, Clamping range, max.: 3.31 mm ² , Pitch: 5.00 mm, No. of poles: 21, 90°, Box
1637540000	BLZ 5.00/21/90B SN SW	PCB plug-in connector, Female connectors, Clamping yoke connection, Clamping range, max.: 3.31 mm ² , Pitch: 5.00 mm, No. of poles: 21, 90°, Box
1637320000	BLZ 5.00/22/90B SN OR	PCB plug-in connector, Female connectors, Clamping yoke connection, Clamping range, max.: 3.31 mm ² , Pitch: 5.00 mm, No. of poles: 22, 90°, Box
1637330000	BLZ 5.00/23/90B SN OR	PCB plug-in connector, Female connectors, Clamping yoke connection, Clamping range, max.: 3.31 mm ² , Pitch: 5.00 mm, No. of poles: 23, 90°, Box
1637340000	BLZ 5.00/24/90B SN OR	PCB plug-in connector, Female connectors, Clamping yoke connection, Clamping range, max.: 3.31 mm ² , Pitch: 5.00 mm, No. of poles: 24, 90°, Box