

Features

- Ideal for indication light on hand held products
- Long life and robust package
- Standard Package: 2,000pcs/ Reel
- MSL (Moisture Sensitivity Level): 3
- RoHS compliant



ATTENTION
OBSERVE PRECAUTIONS
FOR HANDLING
ELECTROSTATIC
DISCHARGE
SENSITIVE
DEVICES

Package Schematics

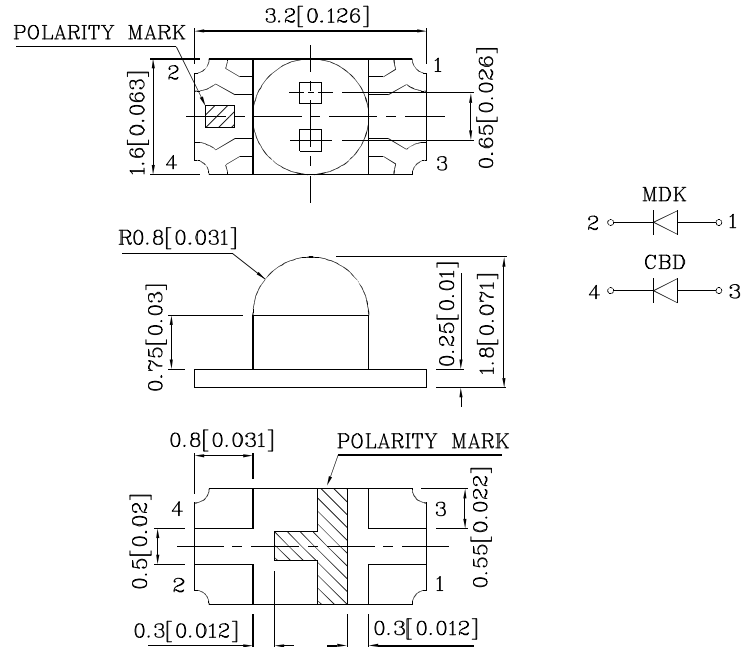

Notes:

1. All dimensions are in millimeters (inches).
2. Tolerance is $\pm 0.2(0.008)$ unless otherwise noted.
3. Specifications are subject to change without notice.

Absolute Maximum Ratings ($T_A=25^\circ\text{C}$)		MDK (AlGaInP)	CBD (InGaN)	Unit
Reverse Voltage	V_R	5	5	V
Forward Current	I_F	30	30	mA
Forward Current (Peak) 1/10 Duty Cycle 0.1ms Pulse Width	i_{FS}	185	150	mA
Power Dissipation	P_D	75	120	mW
Electrostatic Discharge Threshold (HBM)		-	250	V
Operating Temperature	T_A	-40 ~ +85		°C
Storage Temperature	T_{stg}	-40 ~ +85		

Operating Characteristics ($T_A=25^\circ\text{C}$)		MDK (AlGaInP)	CBD (InGaN)	Unit
Forward Voltage (Typ.) ($I_F=20\text{mA}$)	V_F	1.95	3.3	V
Forward Voltage (Max.) ($I_F=20\text{mA}$)	V_F	2.5	4	V
Reverse Current (Max.) ($V_R=5\text{V}$)	I_R	10	50	μA
Wavelength of Peak Emission CIE127-2007* (Typ.) ($I_F=20\text{mA}$)	λ_P	645*	460*	nm
Wavelength of Dominant Emission CIE127-2007* (Typ.) ($I_F=20\text{mA}$)	λ_D	630*	465*	nm
Spectral Line Full Width At Half-Maximum (Typ.) ($I_F=20\text{mA}$)	$\Delta\lambda$	28	25	nm
Capacitance (Typ.) ($V_F=0\text{V}$, $f=1\text{MHz}$)	C	35	100	pF

Part Number	Emitting Color	Emitting Material	Lens-color	Luminous Intensity CIE127-2007* ($I_F=20\text{mA}$) med		Wavelength CIE127-2007* nm λ_P	Viewing Angle 2 θ 1/2
				min.	typ.		
XZMDKCB55W-8	Red	AlGaInP	Water Clear	500	895	645*	30°
	Blue	InGaN		200*	397*		
				100	248	460*	
				100*	248*		

*Luminous intensity value and wavelength are in accordance with CIE127-2007 standards.

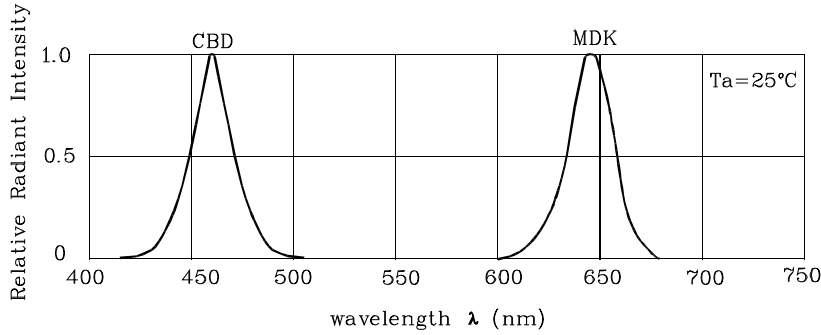

RELATIVE INTENSITY Vs. CIE WAVELENGTH

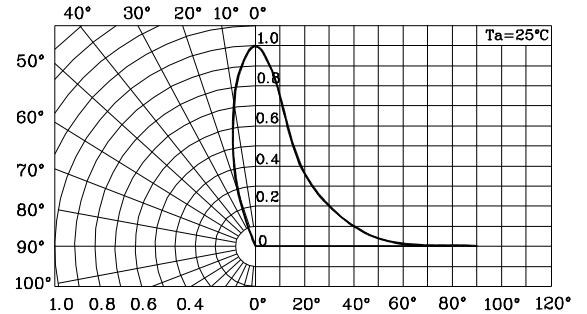

SPATIAL DISTRIBUTION

❖ MDK

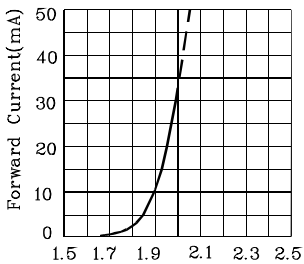

Forward Voltage(V)
FORWARD CURRENT Vs.
FORWARD VOLTAGE

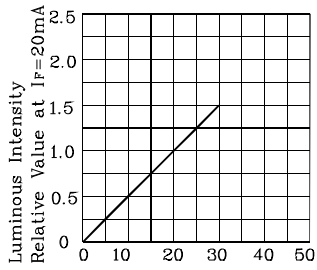

I_f -Forward Current (mA)
LUMINOUS INTENSITY Vs.
FORWARD CURRENT

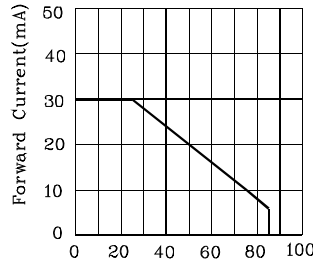

Ambient Temperature T_a (°C)
FORWARD CURRENT
DERATING CURVE

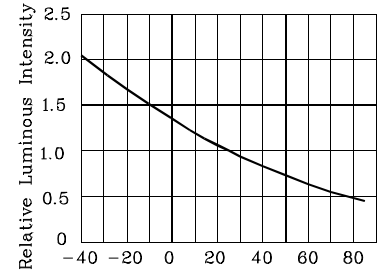

Ambient Temperature T_a (°C)
LUMINOUS INTENSITY Vs.
AMBIENT TEMPERATURE

❖ CBD

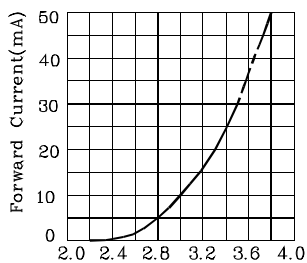

Forward Voltage(V)
FORWARD CURRENT Vs.
FORWARD VOLTAGE

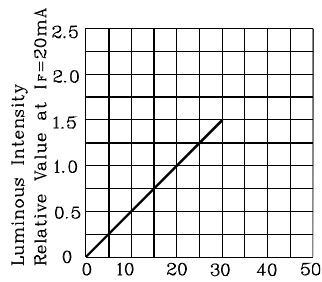

I_f -Forward Current (mA)
LUMINOUS INTENSITY Vs.
FORWARD CURRENT

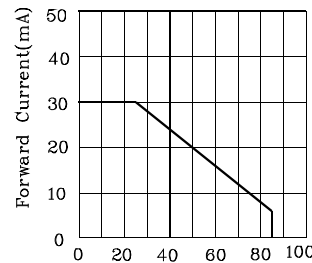

Ambient Temperature T_a (°C)
FORWARD CURRENT
DERATING CURVE

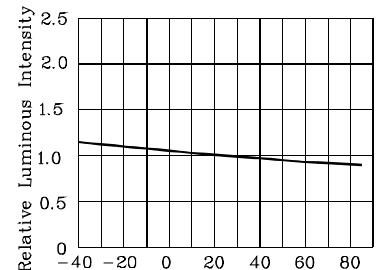

Ambient Temperature T_a (°C)
LUMINOUS INTENSITY Vs.
AMBIENT TEMPERATURE

LED is recommended for reflow soldering and soldering profile is shown below.

❖ The device has a single mounting surface. The device must be mounted according to the specifications.

Reflow Soldering Profile for SMD Products (Pb-Free Components)

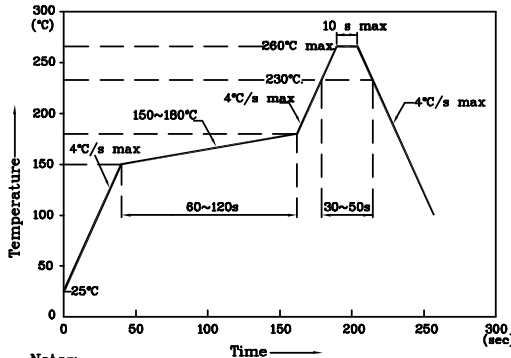

Notes:

1. Maximum soldering temperature should not exceed 260°C
2. Recommended reflow temperature: 145°C-260°C
3. Do not put stress to the epoxy resin during high temperatures conditions

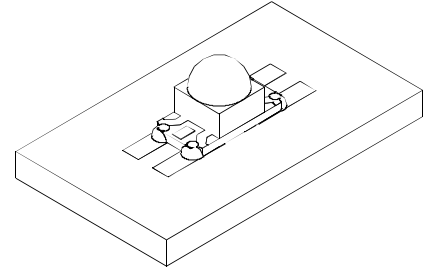

❖ Recommended Soldering Pattern (Units : mm; Tolerance: ± 0.1)

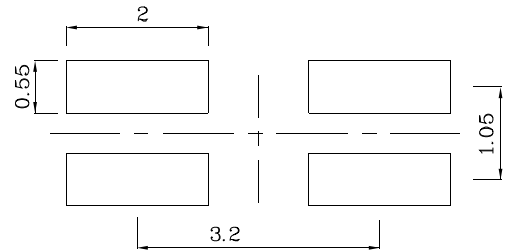

❖ Tape Specification (Units : mm)

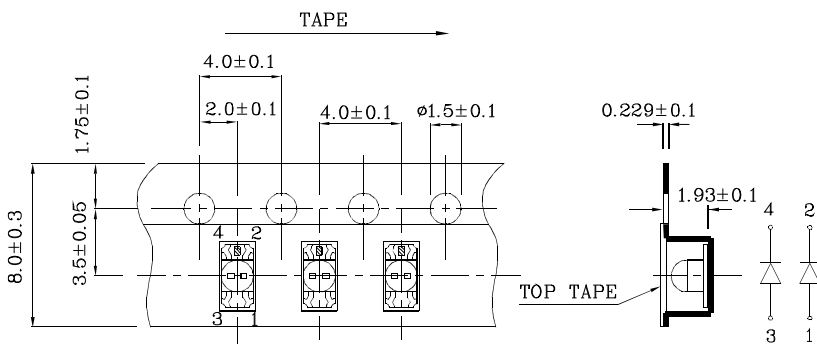

❖ Reel Dimension

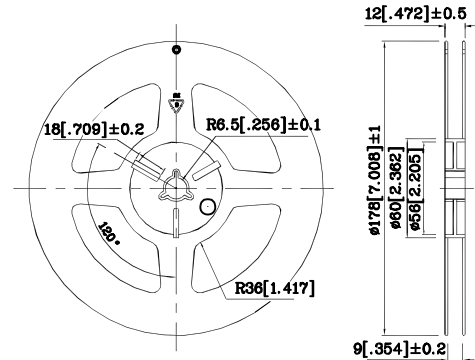



Remarks:



If special sorting is required (e.g. binning based on forward voltage, Luminous intensity / luminous flux, or wavelength), the typical accuracy of the sorting process is as follows:

1. Wavelength: +/-1nm
2. Luminous intensity / luminous flux: +/-15%
3. Forward Voltage: +/-0.1V

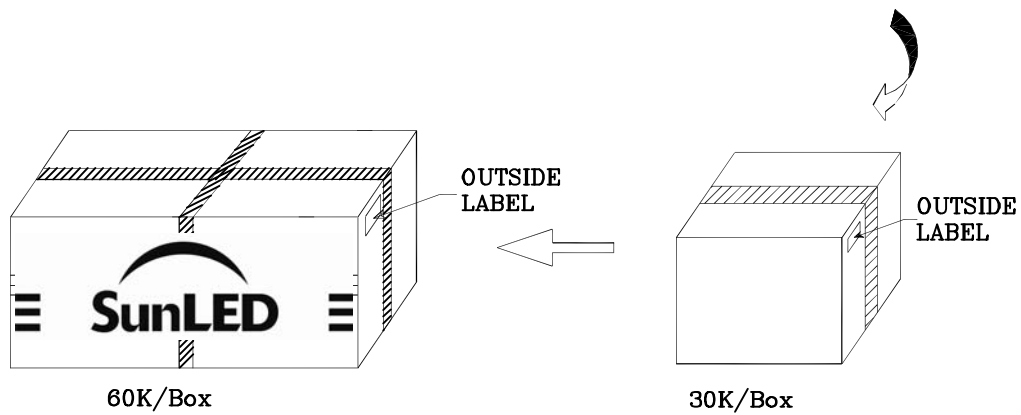
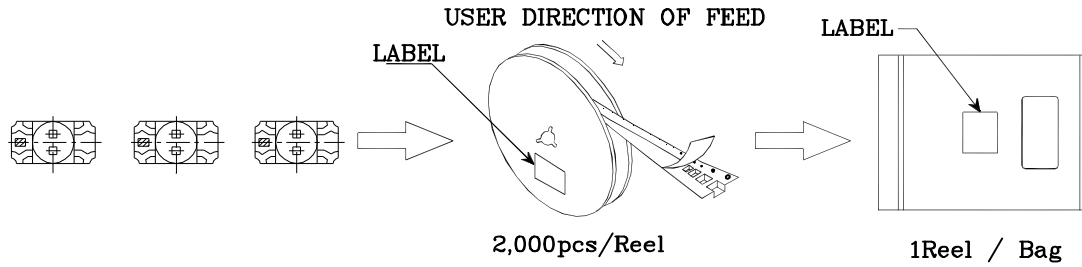
Note: Accuracy may depend on the sorting parameters.

PACKING & LABEL SPECIFICATIONS

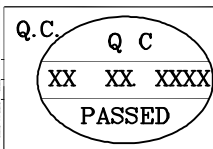
	
P/NO : XZxx55x	
QTY : 2,000 pcs	CODE: XXX
S/N : XX	
LOT NO:	
 XXXXXXXXXXXXXXXXXXXX	
RoHS Compliant	

TERMS OF USE

1. Data presented in this document reflect statistical figures and should be treated as technical reference only.
2. Contents within this document are subject to improvement and enhancement changes without notice.
3. The product(s) in this document are designed to be operated within the electrical and environmental specifications indicated on the datasheet. User accepts full risk and responsibility when operating the product(s) beyond their intended specifications.
4. The product(s) described in this document are intended for electronic applications in which a person's life is not reliant upon the LED. Please consult with a SunLED representative for special applications where the LED may have a direct impact on a person's life.
5. The contents within this document may not be altered without prior consent by SunLED.
6. Additional technical notes are available at <http://www.SunLEDusa.com/TechnicalNotes.asp>