

Excellent Integrated System Limited

Stocking Distributor

Click to view price, real time Inventory, Delivery & Lifecycle Information:

[Weidmüller](#)
[1702470000](#)

For any questions, you can email us directly:

sales@integrated-circuit.com

Product catalogue | PCB connection systems | PCB plug-in connectors | Pitch 7.50 / 7.62 mm (0.295 / 0.300 inch) | Socket connectors, tension clamp connection, pitch 7.50/7.62 | BLZ 7.50-7.62/90/270 | BLZ 7.50/270B

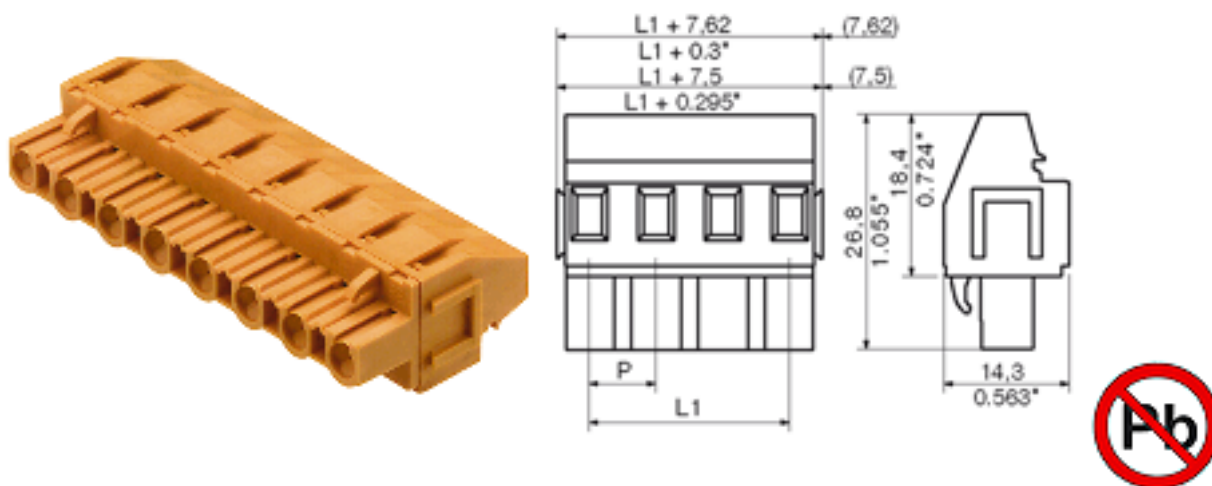
General ordering data

Order No.	1702470000
Part designation	BLZ 7.50/4/270B SN OR
Version	PCB plug-in connector, Female connectors, Clamping yoke connection, Clamping range, max.: 3.31 mm ² , Pitch: 7.50 mm, No. of poles: 4, 270°, Box
EAN	4008190908959
Qty.	100 pc(s).

System parameters

Conductor connection system	Clamping yoke connection
Outgoing direction of conductor	270°
Pitch	7.5 mm
Pitch in inch	0.295 inch
No. of poles	4
No. of rows	1
Screwdriver blade	0.6 x 3.5
Screwdriver blade standard	DIN 5264
Tightening torque, min.	0.4 Nm
Tightening torque, max.	0.5 Nm
Clamping screw	M 2.5
Stripping length	7 mm
L1 in mm	22.5 mm
L1 in inch	0.886 inch
Electric shock protection to DIN VDE 0470	Safe from finger touch

Material data

Insulating material	PBT
Colour	orange
colour chart	Similar to RAL 2000
Insulating material group	IIIa
Flammability class UL 94	V-0
CTI	>= 200
Contact base material	Copper alloy

Product catalogue | PCB connection systems | PCB plug-in connectors | Pitch 7.50 / 7.62 mm (0.295 / 0.300 inch) | Socket connectors, tension clamp connection, pitch 7.50/7.62 | BLZ 7.50-7.62/90/270 | BLZ 7.50/270B

Material data

Contact surface tinned

Connectable conductors

Clamping range, min.	0.13 mm ²
Clamping range, max.	3.31 mm ²
AWG, min.	26
AWG, max.	12
Solid, min. H05(07) V-U	0.2 mm ²
Solid, max. H05(07) V-U	2.5 mm ²
Flexible, min. H05(07) V-K	0.2 mm ²
Flexible, max. H05(07) V-K	2.5 mm ²
With wire end ferrule, acc. to DIN 46 228/1, min.	0.2 mm ²
With wire end ferrule, acc. to DIN 46 228/1, max.	2.5 mm ²
w. plastic collar ferrule, DIN 46228 pt 4, min.	0.2 mm ²
w. plastic collar ferrule, DIN 46228 pt 4, max.	2.5 mm ²
Gauge to EN 60999 a x b; ø	2.8 mm x 2.0 mm; 2.4 mm

DIN IEC rating data

Rated current, min. No. pins (Tu=20°C)	15 A
Rated current, max. No. pins (Tu=20°C)	13 A
Rated current, min. No. pins (Tu=40°C)	12.5 A
Rated current, max. No. pins (Tu=40°C)	11 A
Rated voltage for overvoltage class/pollution severity II/2	800 V
Rated voltage for overvoltage class/pollution severity III/2	800 V
Rated voltage for overvoltage class/pollution severity III/3	500 V
Rated impulse withstand voltage for overvoltage class/pollution severity II/2	8 kV
Rated impulse withstand voltage for overvoltage class/pollution severity III/2	8 kV
Rated impulse withstand voltage for overvoltage class/pollution severity III/3	6 kV
Short-time withstand current resistance	3 x 1s with 120 A

CSA rating data

Rated voltage (Use group D)	300 V
Rated current (Use group D)	10 A
AWG conductor (field wiring), min.	26
AWG conductor (field wiring), max.	12

UL 1059 rating data

Rated voltage (Use group D)	300 V
Rated current (Use group D)	10 A
AWG conductor, min.	26
AWG conductor, max.	12

Approvals

Approvals institutes

Classifications

ETIM 2.0	NK
ETIM 3.0	EC001284
eClass 4.1	27-26-07-01
eClass 5.0	27-26-07-01
eClass 5.1	27-26-07-04

Similar products

Order No.	Part designation	Version
1702450000	BLZ 7.50/2/270B SN OR	PCB plug-in connector, Female connectors, Clamping yoke connection, Clamping range, max.: 3.31 mm ² , Pitch: 7.50 mm, No. of poles: 2, 270°, Box
1702460000	BLZ 7.50/3/270B SN OR	PCB plug-in connector, Female connectors, Clamping yoke connection, Clamping range, max.: 3.31 mm ² , Pitch: 7.50 mm, No. of poles: 3, 270°, Box
1702480000	BLZ 7.50/5/270B SN OR	PCB plug-in connector, Female connectors, Clamping yoke connection, Clamping range, max.: 3.31 mm ² , Pitch: 7.50 mm, No. of poles: 5, 270°, Box
1702490000	BLZ 7.50/6/270B SN OR	PCB plug-in connector, Female connectors, Clamping yoke connection, Clamping range, max.: 3.31 mm ² , Pitch: 7.50 mm, No. of poles: 6, 270°, Box
1702500000	BLZ 7.50/7/270B SN OR	PCB plug-in connector, Female connectors, Clamping yoke connection, Clamping range, max.: 3.31 mm ² , Pitch: 7.50 mm, No. of poles: 7, 270°, Box
1702510000	BLZ 7.50/8/270B SN OR	PCB plug-in connector, Female connectors, Clamping yoke connection, Clamping range, max.: 3.31 mm ² , Pitch: 7.50 mm, No. of poles: 8, 270°, Box
1702520000	BLZ 7.50/9/270B SN OR	PCB plug-in connector, Female connectors, Clamping yoke connection, Clamping range, max.: 3.31 mm ² , Pitch: 7.50 mm, No. of poles: 9, 270°, Box
1702530000	BLZ 7.50/10/270B SN OR	PCB plug-in connector, Female connectors, Clamping yoke connection, Clamping range, max.: 3.31 mm ² , Pitch: 7.50 mm, No. of poles: 10, 270°, Box
1702540000	BLZ 7.50/11/270B SN OR	PCB plug-in connector, Female connectors, Clamping yoke connection, Clamping range, max.: 3.31 mm ² , Pitch: 7.50 mm, No. of poles: 11, 270°, Box
1702550000	BLZ 7.50/12/270B SN OR	PCB plug-in connector, Female connectors, Clamping yoke connection, Clamping range, max.: 3.31 mm ² , Pitch: 7.50 mm, No. of poles: 12, 270°, Box