

Excellent Integrated System Limited

Stocking Distributor

Click to view price, real time Inventory, Delivery & Lifecycle Information:

[Triad Magnetics](#)
[C-24X](#)

For any questions, you can email us directly:
sales@integrated-circuit.com



Inductors

C-24X

Description:

Smoothing chokes are power supply filter chokes having a core with an air gap which prevents saturation at maximum current. Hipot to 1500 VRMS between winding and core for safety.

Electrical Specifications (@25C):

Current DC M/A	Inductance †† Henries	Resistance Ohms
240.0	1.0	50

†† = Inductance tolerance -20%, + 50 %

Dimensions:

Unit: In inches

A	B	C	D
1.625	2.812	1.50	2.375

Weight: 0.75 lbs.

Schematic:

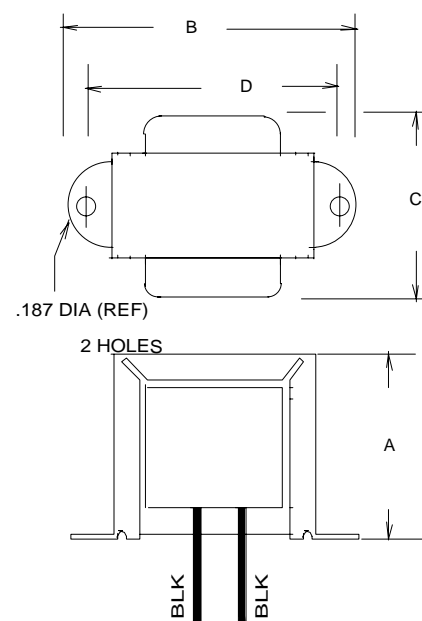
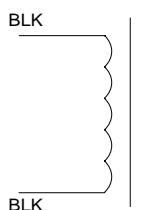

RoHS Compliance: As of manufacturing date February 2005, all standard products meet the requirements of 2011/65/EU, known as the RoHS initiative.

* Upon printing, this document is considered "uncontrolled". Please contact Triad Magnetics' website for the most current version

Web: www.TriadMagnetics.com
Phone 951-277-0757
Fax 951-277-2757

460 Harley Knox Blvd.
Perris, California 92571

Publish Date: December 4, 2013