

## Excellent Integrated System Limited

Stocking Distributor

Click to view price, real time Inventory, Delivery & Lifecycle Information:

[Vishay Semiconductor/Diodes Division](#)  
[VS-UFL60FA60P](#)

For any questions, you can email us directly:

[sales@integrated-circuit.com](mailto:sales@integrated-circuit.com)



## UFL60FA60P

Vishay Semiconductors

### Insulated Ultrafast Rectifier Module, 60 A



SOT-227

#### FEATURES

- Two fully independent diodes
- Ceramic fully insulated package ( $V_{ISOL} = 2500 V_{AC}$ )
- Ultrafast reverse recovery
- Ultrasoft reverse recovery current shape
- Low forward voltage
- Optimized for power conversion: welding and industrial SMPS applications
- Industry standard outline
- Plug-in compatible with other SOT-227 packages
- Easy to assemble
- Direct mounting to heatsink
- UL approved file E78996 
- Compliant to RoHS directive 2002/95/EC
- Designed and qualified for industrial level



**RoHS**  
COMPLIANT

PRODUCT SUMMARY	
$V_R$	600 V
$I_{F(AV)}$ per module at $T_C = 114\text{ }^\circ\text{C}$	60 A
$t_{rr}$	120 ns

#### DESCRIPTION

The UFL60FA60P insulated modules integrate two state of the art Vishay Semiconductors ultrafast recovery rectifiers in the compact, industry standard SOT-227 package. The planar structure of the diodes, and the platinum doping life time control, provide an ultrasoft recovery current shape, together with the best overall performance, ruggedness, and reliability characteristics.

These devices are thus intended for high frequency applications in which the switching energy is designed not to be a predominant portion of the total energy, such as in the output rectification stage of welding machines, SMPS, and DC/DC converters. Their extremely optimized stored charge and low recovery current reduce both over dissipation in the switching elements (and snubbers) and EMI/RFI.

ABSOLUTE MAXIMUM RATINGS				
PARAMETER	SYMBOL	TEST CONDITIONS	MAX.	UNITS
Cathode to anode voltage	$V_R$		600	V
Continuous forward current per diode	$I_F$	$T_C = 85\text{ }^\circ\text{C}$	48	A
Single pulse forward current per diode	$I_{FSM}$	$T_C = 25\text{ }^\circ\text{C}$	300	
Maximum power dissipation per module	$P_D$	$T_C = 85\text{ }^\circ\text{C}$	120	W
RMS isolation voltage	$V_{ISOL}$	Any terminal to case, $t = 1\text{ min}$	2500	V
Operating junction and storage temperatures	$T_J, T_{Stg}$		- 55 to 175	$^\circ\text{C}$

# UFL60FA60P

Vishay Semiconductors

Insulated Ultrafast Rectifier Module, 60 A



ELECTRICAL SPECIFICATIONS (T <sub>J</sub> = 25 °C unless otherwise specified)							
PARAMETER	SYMBOL	TEST CONDITIONS	MIN.	TYP.	MAX.	UNITS	
Cathode to anode breakdown voltage	V <sub>BR</sub>	I <sub>R</sub> = 100 μA	600	-	-	V	
Forward voltage	V <sub>FM</sub>	I <sub>F</sub> = 30 A	-	1.1	1.3		
		I <sub>F</sub> = 60 A	-	1.27	1.4		
		I <sub>F</sub> = 30 A	T <sub>J</sub> = 125 °C	-	1.0		1.23
		I <sub>F</sub> = 60 A		-	1.17		1.35
Reverse leakage current	I <sub>RM</sub>	V <sub>R</sub> = V <sub>R</sub> rated	-	0.1	100	μA	
		T <sub>J</sub> = 175 °C, V <sub>R</sub> = V <sub>R</sub> rated	-	0.2	1.0	mA	
Junction capacitance	C <sub>T</sub>	V <sub>R</sub> = 600 V	-	50	-	pF	

DYNAMIC RECOVERY CHARACTERISTICS (T <sub>J</sub> = 25 °C unless otherwise specified)							
PARAMETER	SYMBOL	TEST CONDITIONS	MIN.	TYP.	MAX.	UNITS	
Reverse recovery time	t <sub>rr</sub>	T <sub>J</sub> = 25 °C	-	120	157	ns	
		T <sub>J</sub> = 125 °C	-	206	252		
Peak recovery current	I <sub>RRM</sub>	T <sub>J</sub> = 25 °C	I <sub>F</sub> = 30 A di/dt = 200 A/μs V <sub>R</sub> = 200 V	-	11	15	A
		T <sub>J</sub> = 125 °C		-	20	25	
Reverse recovery charge	Q <sub>rr</sub>	T <sub>J</sub> = 25 °C		-	600	1178	nC
		T <sub>J</sub> = 125 °C		-	2060	3150	

THERMAL - MECHANICAL SPECIFICATIONS						
PARAMETER	SYMBOL	TEST CONDITIONS	MIN.	TYP.	MAX.	UNITS
Junction to case, single leg conducting	R <sub>thJC</sub>		-	-	1.5	°C/W
Junction to case, both leg conducting			-	-	0.75	
Case to heatsink	R <sub>thCS</sub>	Flat, greased surface	-	0.05	-	
Weight			-	30	-	g
Mounting torque			-	1.3	-	N · m



**UFL60FA60P**

Insulated Ultrafast  
Rectifier Module, 60 A

Vishay Semiconductors

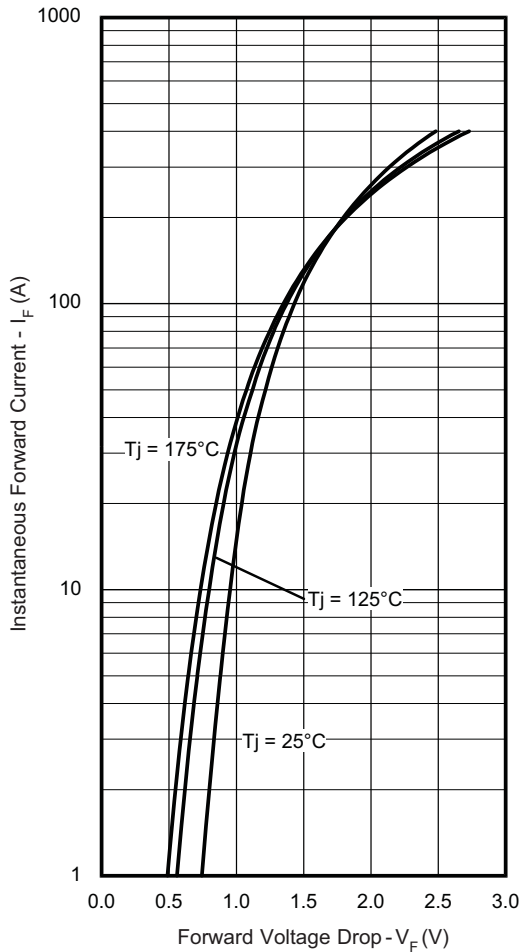

Fig. 1 - Typical Forward Voltage Drop Characteristics (Per Diode)

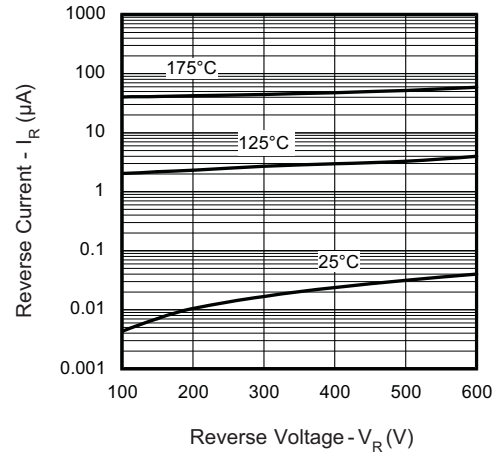

Fig. 2 - Typical Values of Reverse Current vs. Reverse Voltage

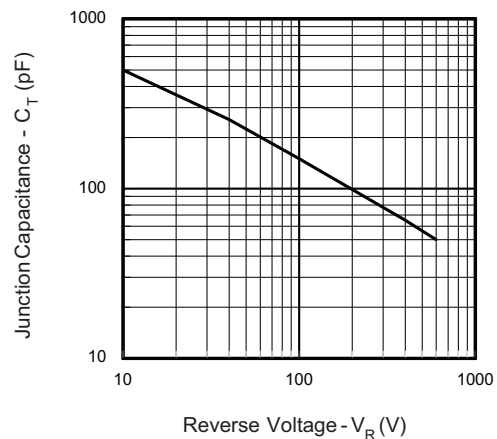

Fig. 3 - Typical Junction Capacitance vs. Reverse Voltage

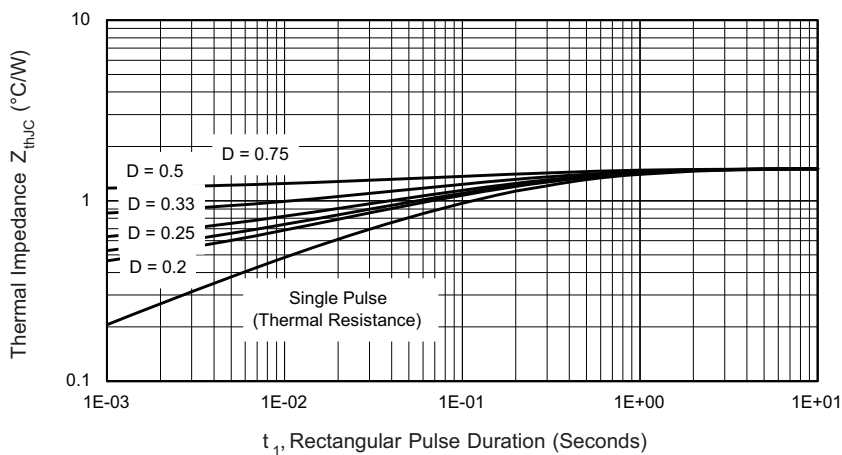

Fig. 4 - Maximum Thermal Impedance  $Z_{thJC}$  Characteristics (Per Diode)

# UFL60FA60P

Vishay Semiconductors

Insulated Ultrafast Rectifier Module, 60 A

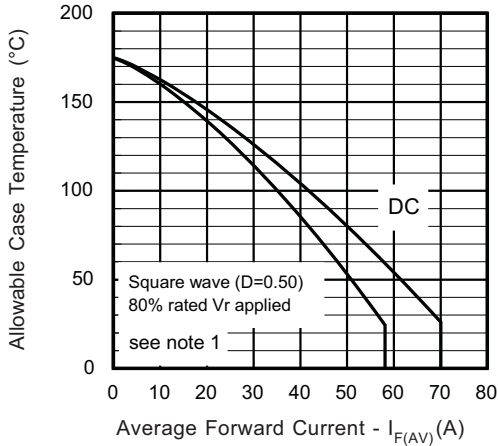

Fig. 5 - Maximum Allowable Case Temperature vs. Average Forward Current (Per Leg)

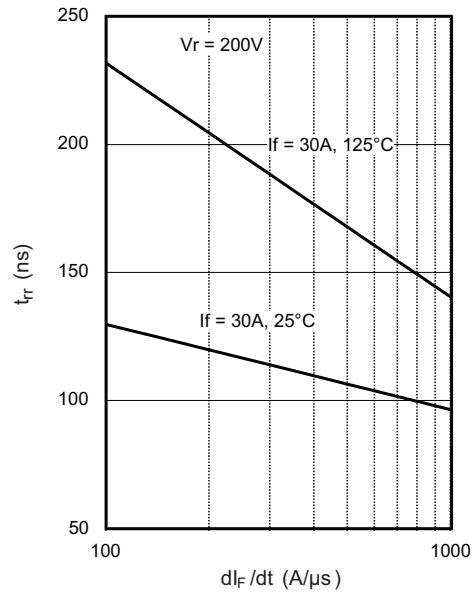

Fig. 7 - Typical Reverse Recovery Time vs.  $dI_F/dt$

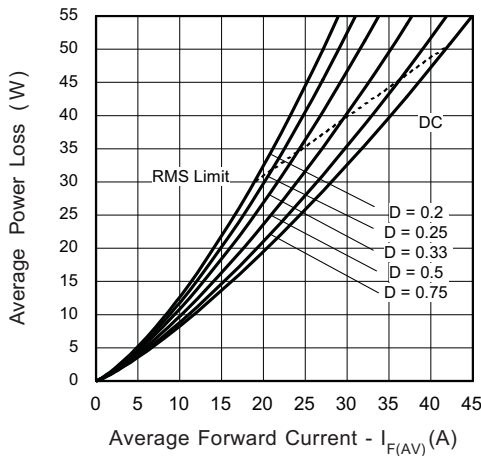

Fig. 6 - Forward Power Loss Characteristics (Per Leg)

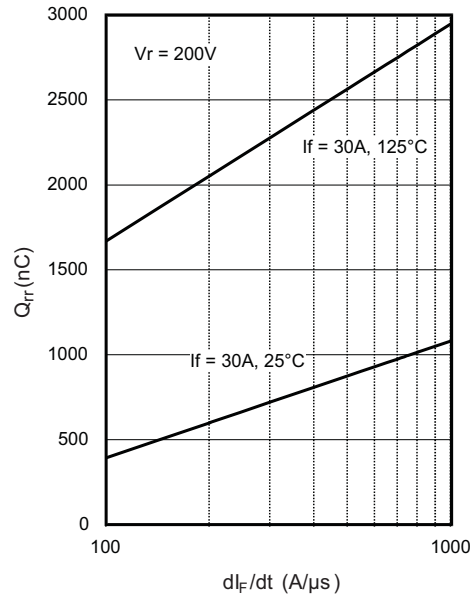

Fig. 8 - Typical Stored Charge vs.  $dI_F/dt$

**Note**

(1) Formula used:  $T_C = T_J - (P_d + P_{dREV}) \times R_{thJC}$ ;  
 $P_d$  = Forward power loss =  $I_{F(AV)} \times V_{FM}$  at  $(I_{F(AV)}/D)$  (see fig. 6);  
 $P_{dREV}$  = Inverse power loss =  $V_{R1} \times I_R (1 - D)$ ;  $I_R$  at  $V_{R1} = 80\%$  rated  $V_R$



**UFL60FA60P**

Insulated Ultrafast Rectifier Module, 60 A

Vishay Semiconductors

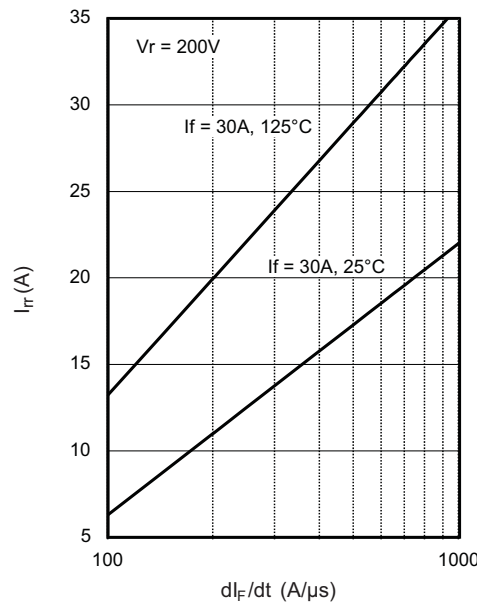

Fig. 9 - Typical Stored Current vs.  $dI_F/dt$

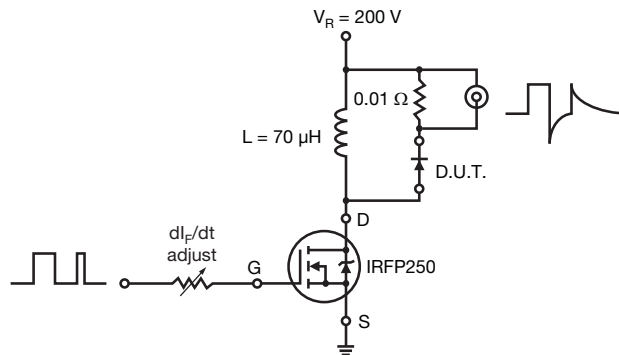
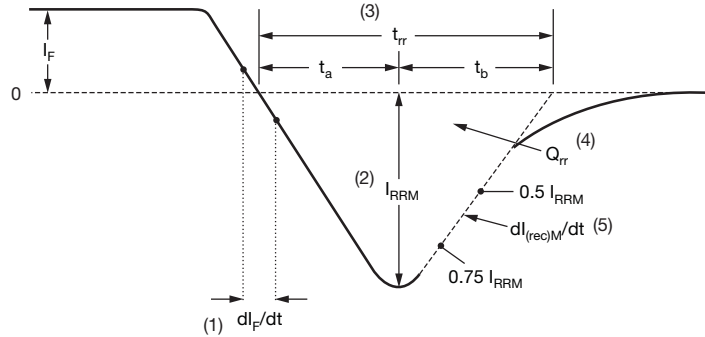

Fig. 10 - Reverse Recovery Parameter Test Circuit

# UFL60FA60P

Vishay Semiconductors

Insulated Ultrafast Rectifier Module, 60 A



- (1)  $di_F/dt$  - rate of change of current through zero crossing
- (2)  $I_{RRM}$  - peak reverse recovery current
- (3)  $t_{rr}$  - reverse recovery time measured from zero crossing point of negative going  $I_F$  to point where a line passing through  $0.75 I_{RRM}$  and  $0.50 I_{RRM}$  extrapolated to zero current.
- (4)  $Q_{rr}$  - area under curve defined by  $t_{rr}$  and  $I_{RRM}$   

$$Q_{rr} = \frac{t_{rr} \times I_{RRM}}{2}$$
- (5)  $di_{(rec)M}/dt$  - peak rate of change of current during  $t_b$  portion of  $t_{rr}$

Fig. 11 - Reverse Recovery Waveform and Definitions

## ORDERING INFORMATION TABLE

Device code	<b>UF</b>	<b>L</b>	<b>60</b>	<b>F</b>	<b>A</b>	<b>60</b>	<b>P</b>		
	①	②	③	④	⑤	⑥	⑦		
	<b>1</b>	-	Ultrafast rectifier	<b>2</b>	-	Ultrafast Pt low $V_F$	<b>3</b>	-	Current rating (60 = 60 A)
	<b>4</b>	-	Circuit configuration (2 separate diodes, parallel pin-out)	<b>5</b>	-	Package indicator (SOT-227 standard isolated base)	<b>6</b>	-	Voltage rating (60 = 600 V)
	<b>7</b>	-	P = Lead (Pb)-free						

## CIRCUIT CONFIGURATION

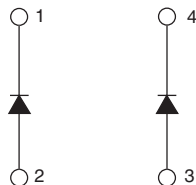

LINKS TO RELATED DOCUMENTS	
Dimensions	<a href="http://www.vishay.com/doc?95036">www.vishay.com/doc?95036</a>
Packaging information	<a href="http://www.vishay.com/doc?95037">www.vishay.com/doc?95037</a>



## Disclaimer

ALL PRODUCT, PRODUCT SPECIFICATIONS AND DATA ARE SUBJECT TO CHANGE WITHOUT NOTICE TO IMPROVE RELIABILITY, FUNCTION OR DESIGN OR OTHERWISE.

Vishay Intertechnology, Inc., its affiliates, agents, and employees, and all persons acting on its or their behalf (collectively, "Vishay"), disclaim any and all liability for any errors, inaccuracies or incompleteness contained in any datasheet or in any other disclosure relating to any product.

Vishay makes no warranty, representation or guarantee regarding the suitability of the products for any particular purpose or the continuing production of any product. To the maximum extent permitted by applicable law, Vishay disclaims (i) any and all liability arising out of the application or use of any product, (ii) any and all liability, including without limitation special, consequential or incidental damages, and (iii) any and all implied warranties, including warranties of fitness for particular purpose, non-infringement and merchantability.

Statements regarding the suitability of products for certain types of applications are based on Vishay's knowledge of typical requirements that are often placed on Vishay products in generic applications. Such statements are not binding statements about the suitability of products for a particular application. It is the customer's responsibility to validate that a particular product with the properties described in the product specification is suitable for use in a particular application. Parameters provided in datasheets and/or specifications may vary in different applications and performance may vary over time. All operating parameters, including typical parameters, must be validated for each customer application by the customer's technical experts. Product specifications do not expand or otherwise modify Vishay's terms and conditions of purchase, including but not limited to the warranty expressed therein.

Except as expressly indicated in writing, Vishay products are not designed for use in medical, life-saving, or life-sustaining applications or for any other application in which the failure of the Vishay product could result in personal injury or death. Customers using or selling Vishay products not expressly indicated for use in such applications do so at their own risk. Please contact authorized Vishay personnel to obtain written terms and conditions regarding products designed for such applications.

No license, express or implied, by estoppel or otherwise, to any intellectual property rights is granted by this document or by any conduct of Vishay. Product names and markings noted herein may be trademarks of their respective owners.

## Material Category Policy

**Vishay Intertechnology, Inc. hereby certifies that all its products that are identified as RoHS-Compliant fulfill the definitions and restrictions defined under Directive 2011/65/EU of The European Parliament and of the Council of June 8, 2011 on the restriction of the use of certain hazardous substances in electrical and electronic equipment (EEE) - recast, unless otherwise specified as non-compliant.**

**Please note that some Vishay documentation may still make reference to RoHS Directive 2002/95/EC. We confirm that all the products identified as being compliant to Directive 2002/95/EC conform to Directive 2011/65/EU.**

**Vishay Intertechnology, Inc. hereby certifies that all its products that are identified as Halogen-Free follow Halogen-Free requirements as per JEDEC JS709A standards. Please note that some Vishay documentation may still make reference to the IEC 61249-2-21 definition. We confirm that all the products identified as being compliant to IEC 61249-2-21 conform to JEDEC JS709A standards.**