

Excellent Integrated System Limited

Stocking Distributor

Click to view price, real time Inventory, Delivery & Lifecycle Information:

[Weidmüller](#)
[1605120000](#)

For any questions, you can email us directly:

sales@integrated-circuit.com

Product catalogue | PCB connection systems | PCB plug-in connectors | Pitch 3.50 mm (0.138 inch) | Plug connectors, solder connection, pitch 3.5 | SL 3.5/90 | SL 3.5/90G

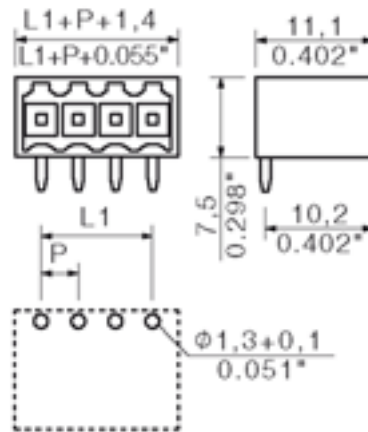
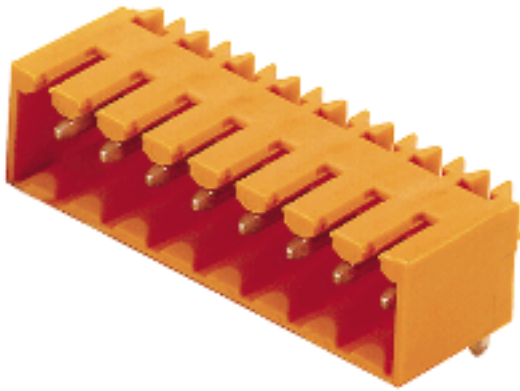

General ordering data

Order No.	1605120000
Part designation	SL 3.5/7/90G3.2SN OR
Version	PCB plug-in connector, Male connectors, Soldered connection, Pitch: 3.50 mm, No. of poles: 7, 90°, Box
EAN	4008190169954
Qty.	50 pc(s).

System parameters

Fitted to PCB	Soldered connection
Outgoing elbow	90°
Pitch	3.5 mm
Pitch in inch	0.138 inch
No. of poles	7
Solder pin length	3.2 mm
Can be coded	Yes
No. of rows	1
No. of solder pins per pole	1
Dia. of fitting hole	1.3 mm
Fitting hole tolerance	+ 0.1 mm
L1 in mm	21 mm
L1 in inch	0.827 inch
Insulation resistance	1 MΩ

System parameters

Electric shock protection to DIN VDE 0470	IP 10
Electric shock protection to DIN VDE 0470	Safe from back-of-hand touch

Material data

Insulating material	PBT
Colour	orange
colour chart	Similar to RAL 2000
Insulating material group	IIIa
Flammability class UL 94	V-0
CTI	>= 200
Contact base material	CuSn
Contact surface	tinned
Constant operating temp., min.	-25 °C
Constant operating temp., max.	100 °C
Storage temperature, min.	-25 °C
Storage temperature, max.	55 °C
Max. relative humidity during storage	80 %

DIN IEC rating data

Rated current, min. No. pins (Tu=20°C)	17 A
Rated current, max. No. pins (Tu=20°C)	12 A
Rated current, min. No. pins (Tu=40°C)	14.5 A
Rated current, max. No. pins (Tu=40°C)	10 A
Rated voltage for overvoltage class/pollution severity III/3	160 V
Rated impulse withstand voltage for overvoltage class/pollution severity III/3	2.5 kV
Rated voltage for overvoltage class/pollution severity III/2	160 V
Rated impulse withstand voltage for overvoltage class/pollution severity III/2	2.5 kV
Rated voltage for overvoltage class/pollution severity II/2	320 V
Rated impulse withstand voltage for overvoltage class/pollution severity II/2	2.5 kV
Short-time withstand current resistance	3 x 1s with 100 A

CSA rating data

Rated voltage (Use group D)	300 V
Rated current (Use group D)	10 A

UL 1059 rating data

Rated voltage (Use group D)	300 V
Rated current (Use group D)	10 A

Approvals

Approvals institutes



Downloads

CAD Library (P-CAD Format - Standard) SL.LIB

Classifications

ETIM 2.0	NK
ETIM 3.0	EC001284
eClass 4.1	27-26-07-01
eClass 5.0	27-26-07-01
eClass 5.1	27-26-07-04

Similar products

Order No.	Part designation	Version
1605070000	SL 3.5/2/90G3.2SN OR	PCB plug-in connector, Male connectors, Soldered connection, Pitch: 3.50 mm, No. of poles: 2, 90°, Box
1605080000	SL 3.5/3/90G3.2SN OR	PCB plug-in connector, Male connectors, Soldered connection, Pitch: 3.50 mm, No. of poles: 3, 90°, Box
1605090000	SL 3.5/4/90G3.2SN OR	PCB plug-in connector, Male connectors, Soldered connection, Pitch: 3.50 mm, No. of poles: 4, 90°, Box
1605100000	SL 3.5/5/90G3.2SN OR	PCB plug-in connector, Male connectors, Soldered connection, Pitch: 3.50 mm, No. of poles: 5, 90°, Box
1605110000	SL 3.5/6/90G3.2SN OR	PCB plug-in connector, Male connectors, Soldered connection, Pitch: 3.50 mm, No. of poles: 6, 90°, Box
1605130000	SL 3.5/8/90G3.2SN OR	PCB plug-in connector, Male connectors, Soldered connection, Pitch: 3.50 mm, No. of poles: 8, 90°, Box
1605140000	SL 3.5/9/90G3.2SN OR	PCB plug-in connector, Male connectors, Soldered connection, Pitch: 3.50 mm, No. of poles: 9, 90°, Box
1605150000	SL 3.5/10/90G3.2SN OR	PCB plug-in connector, Male connectors, Soldered connection, Pitch: 3.50 mm, No. of poles: 10, 90°, Box
1605160000	SL 3.5/11/90G3.2SN OR	PCB plug-in connector, Male connectors, Soldered connection, Pitch: 3.50 mm, No. of poles: 11, 90°, Box
1605170000	SL 3.5/12/90G3.2SN OR	PCB plug-in connector, Male connectors, Soldered connection, Pitch: 3.50 mm, No. of poles: 12, 90°, Box

1605180000	SL 3.5/13/90G3.2SN OR	PCB plug-in connector, Male connectors, Soldered connection, Pitch: 3.50 mm, No. of poles: 13, 90°, Box
1605190000	SL 3.5/14/90G3.2SN OR	PCB plug-in connector, Male connectors, Soldered connection, Pitch: 3.50 mm, No. of poles: 14, 90°, Box
1605200000	SL 3.5/15/90G3.2SN OR	PCB plug-in connector, Male connectors, Soldered connection, Pitch: 3.50 mm, No. of poles: 15, 90°, Box
1605210000	SL 3.5/16/90G3.2SN OR	PCB plug-in connector, Male connectors, Soldered connection, Pitch: 3.50 mm, No. of poles: 16, 90°, Box
1619380000	SL 3.5/17/90G3.2SN OR	PCB plug-in connector, Male connectors, Soldered connection, Pitch: 3.50 mm, No. of poles: 17, 90°, Box
1619390000	SL 3.5/18/90G3.2SN OR	PCB plug-in connector, Male connectors, Soldered connection, Pitch: 3.50 mm, No. of poles: 18, 90°, Box
1619400000	SL 3.5/19/90G3.2SN OR	PCB plug-in connector, Male connectors, Soldered connection, Pitch: 3.50 mm, No. of poles: 19, 90°, Box
1619410000	SL 3.5/20/90G3.2SN OR	PCB plug-in connector, Male connectors, Soldered connection, Pitch: 3.50 mm, No. of poles: 20, 90°, Box
1619420000	SL 3.5/21/90G3.2SN OR	PCB plug-in connector, Male connectors, Soldered connection, Pitch: 3.50 mm, No. of poles: 21, 90°, Box
1619430000	SL 3.5/22/90G3.2SN OR	PCB plug-in connector, Male connectors, Soldered connection, Pitch: 3.50 mm, No. of poles: 22, 90°, Box
1619440000	SL 3.5/23/90G3.2SN OR	PCB plug-in connector, Male connectors, Soldered connection, Pitch: 3.50 mm, No. of poles: 23, 90°, Box
1619450000	SL 3.5/24/90G3.2SN OR	PCB plug-in connector, Male connectors, Soldered connection, Pitch: 3.50 mm, No. of poles: 24, 90°, Box