

Excellent Integrated System Limited

Stocking Distributor

Click to view price, real time Inventory, Delivery & Lifecycle Information:

[Weidmüller](#)
[1614940000](#)

For any questions, you can email us directly:
sales@integrated-circuit.com

Product catalogue | PCB connection systems | PCB plug-in connectors | Pitch 5.00 / 5.08 mm (0.197 / 0.200 inch) | Plug connectors, solder connection, pitch 5.00/5.08 | SLD 5.00-5.08 | SLD 5.00/180G

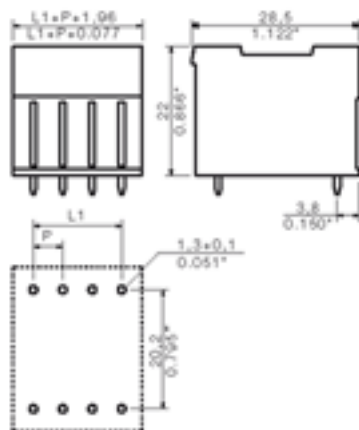
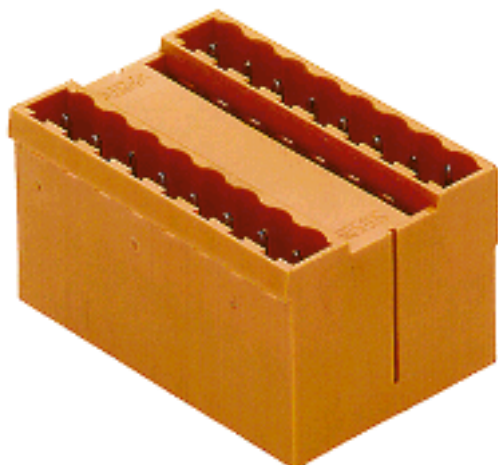

General ordering data

Order No.	1614940000
Part designation	SLD 5.00R20/30/3.2SN OR
Version	PCB plug-in connector, Male connectors, Soldered connection, Pitch: 5.00 mm, No. of poles: 30, 180°, Box
EAN	4008190040529
Qty.	10 pc(s).

System parameters

Fitted to PCB	Soldered connection
Outgoing elbow	180°
Pitch	5 mm
Pitch in inch	0.197 inch
No. of poles	30
Solder pin length	3.2 mm
Can be coded	Yes
No. of rows	2
No. of solder pins per pole	1
Dia. of fitting hole	1.3 mm
Fitting hole tolerance	+ 0.1 mm
L1 in mm	70 mm
L1 in inch	2.756 inch
Insulation resistance	1 MΩ

Product catalogue | PCB connection systems | PCB plug-in connectors | Pitch 5.00 / 5.08 mm (0.197 / 0.200 inch) | Plug connectors, solder connection, pitch 5.00/5.08 | SLD 5.00-5.08 | SLD 5.00/180G

System parameters

Electric shock protection to DIN VDE 0470 Safe from back-of-hand touch

Material data

Insulating material	PBT
Colour	orange
colour chart	Similar to RAL 2000
Insulating material group	I
Flammability class UL 94	V-0
CTI	>= 600
Contact base material	CuSn
Contact surface	tinned
Constant operating temp., min.	-25 °C
Constant operating temp., max.	100 °C
Storage temperature, min.	-25 °C
Storage temperature, max.	55 °C
Max. relative humidity during storage	80 %

DIN IEC rating data

Rated current, min. No. pins (Tu=20°C)	11 A
Rated current, max. No. pins (Tu=20°C)	8.5 A
Rated current, min. No. pins (Tu=40°C)	9.5 A
Rated current, max. No. pins (Tu=40°C)	7 A
Rated voltage for overvoltage class/pollution severity III/3	250 V
Rated impulse withstand voltage for overvoltage class/pollution severity III/3	4 kV
Rated voltage for overvoltage class/pollution severity III/2	320 V
Rated impulse withstand voltage for overvoltage class/pollution severity III/2	4 kV
Rated voltage for overvoltage class/pollution severity II/2	400 V
Rated impulse withstand voltage for overvoltage class/pollution severity II/2	4 kV
Short-time withstand current resistance	1 x 1s with 120 A

CSA rating data

Rated voltage (Use group D)	300 V
Rated current (Use group D)	10 A

UL 1059 rating data

Rated voltage (Use group D)	300 V
Rated current (Use group D)	10 A

Approvals

Approvals institutes



Product catalogue | PCB connection systems | PCB plug-in connectors | Pitch 5.00 / 5.08 mm (0.197 / 0.200 inch) | Plug connectors, solder connection, pitch 5.00/5.08 | SLD 5.00-5.08 | SLD 5.00/180G

Classifications

ETIM 2.0	NK
ETIM 3.0	EC001284
eClass 4.1	27-26-07-01
eClass 5.0	27-26-07-01
eClass 5.1	27-26-07-04

Similar products

Order No.	Part designation	Version
1614810000	SLD 5.00R20/4/3.2SN OR	PCB plug-in connector, Male connectors, Soldered connection, Pitch: 5.00 mm, No. of poles: 4, 180°, Box
1614820000	SLD 5.00R20/6/3.2SN OR	PCB plug-in connector, Male connectors, Soldered connection, Pitch: 5.00 mm, No. of poles: 6, 180°, Box
1614830000	SLD 5.00R20/8/3.2SN OR	PCB plug-in connector, Male connectors, Soldered connection, Pitch: 5.00 mm, No. of poles: 8, 180°, Box
1614840000	SLD 5.00R20/10/3.2SN OR	PCB plug-in connector, Male connectors, Soldered connection, Pitch: 5.00 mm, No. of poles: 10, 180°, Box
1614850000	SLD 5.00R20/12/3.2SN OR	PCB plug-in connector, Male connectors, Soldered connection, Pitch: 5.00 mm, No. of poles: 12, 180°, Box
1614860000	SLD 5.00R20/14/3.2SN OR	PCB plug-in connector, Male connectors, Soldered connection, Pitch: 5.00 mm, No. of poles: 14, 180°, Box
1614870000	SLD 5.00R20/16/3.2SN OR	PCB plug-in connector, Male connectors, Soldered connection, Pitch: 5.00 mm, No. of poles: 16, 180°, Box
1614880000	SLD 5.00R20/18/3.2SN OR	PCB plug-in connector, Male connectors, Soldered connection, Pitch: 5.00 mm, No. of poles: 18, 180°, Box
1614890000	SLD 5.00R20/20/3.2SN OR	PCB plug-in connector, Male connectors, Soldered connection, Pitch: 5.00 mm, No. of poles: 20, 180°, Box
1614900000	SLD 5.00R20/22/3.2SN OR	PCB plug-in connector, Male connectors, Soldered connection, Pitch: 5.00 mm, No. of poles: 22, 180°, Box
1614910000	SLD 5.00R20/24/3.2SN OR	PCB plug-in connector, Male connectors, Soldered connection, Pitch: 5.00 mm, No. of poles: 24, 180°, Box
1614920000	SLD 5.00R20/26/3.2SN OR	PCB plug-in connector, Male connectors, Soldered connection, Pitch: 5.00 mm, No. of poles: 26, 180°, Box
1614930000	SLD 5.00R20/28/3.2SN OR	PCB plug-in connector, Male connectors, Soldered connection, Pitch: 5.00 mm, No. of poles: 28, 180°, Box
1614950000	SLD 5.00R20/32/3.2SN OR	PCB plug-in connector, Male connectors, Soldered connection, Pitch: 5.00 mm, No. of poles: 32, 180°, Box
1614960000	SLD 5.00R20/34/3.2SN OR	PCB plug-in connector, Male connectors, Soldered connection, Pitch: 5.00 mm, No. of poles: 34, 180°, Box
1614970000	SLD 5.00R20/36/3.2SN OR	PCB plug-in connector, Male connectors, Soldered connection, Pitch: 5.00 mm, No. of poles: 36, 180°, Box
1614980000	SLD 5.00R20/38/3.2SN OR	PCB plug-in connector, Male connectors, Soldered connection, Pitch: 5.00 mm, No. of poles: 38, 180°, Box
1614990000	SLD 5.00R20/40/3.2SN OR	PCB plug-in connector, Male connectors, Soldered connection, Pitch: 5.00 mm, No. of poles: 40, 180°, Box
1615000000	SLD 5.00R20/42/3.2SN OR	PCB plug-in connector, Male connectors, Soldered connection, Pitch: 5.00 mm, No. of poles: 42, 180°, Box
1615010000	SLD 5.00R20/44/3.2SN OR	PCB plug-in connector, Male connectors, Soldered connection, Pitch: 5.00 mm, No. of poles: 44, 180°, Box

Product catalogue | PCB connection systems | PCB plug-in connectors | Pitch 5.00 / 5.08 mm (0.197 / 0.200 inch) | Plug connectors, solder connection, pitch 5.00/5.08 | SLD 5.00-5.08 | SLD 5.00/180G

1615020000	SLD 5.00R20/46/3.2SN OR	PCB plug-in connector, Male connectors, Soldered connection, Pitch: 5.00 mm, No. of poles: 46, 180°, Box
1615030000	SLD 5.00R20/48/3.2SN OR	PCB plug-in connector, Male connectors, Soldered connection, Pitch: 5.00 mm, No. of poles: 48, 180°, Box