

Excellent Integrated System Limited

Stocking Distributor

Click to view price, real time Inventory, Delivery & Lifecycle Information:

[Weidmüller](#)
[1627380000](#)

For any questions, you can email us directly:

sales@integrated-circuit.com

Product catalogue | PCB connection systems | PCB plug-in connectors | Pitch 5.00 / 5.08 mm (0.197 / 0.200 inch) | Plug connectors, tension clamp connection, pitch 5.00/5.08 | SLS 5.08 | SLS 5.08/180B

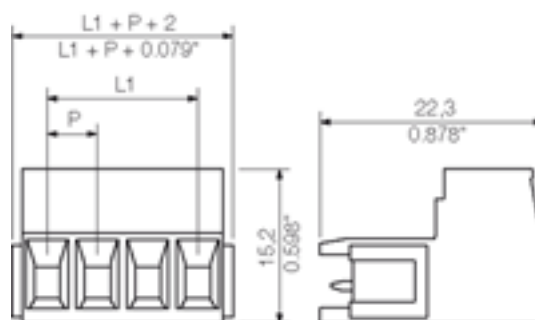
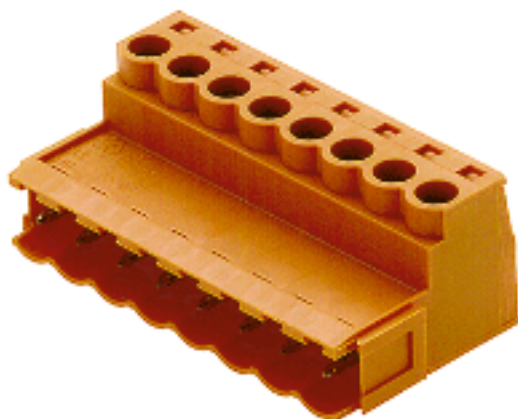

General ordering data

Order No.	1627380000
Part designation	SLS 5.08/16B SN OR
Version	PCB plug-in connector, Male connectors, Clamping yoke connection, Clamping range, max.: 3.31 mm ² , Pitch: 5.08 mm, No. of poles: 16, 180°, Box
EAN	4008190199890
Qty.	50 pc(s).

System parameters

Conductor connection system	Clamping yoke connection
Outgoing direction of conductor	180°
Pitch	5.08 mm
Pitch in inch	0.2 inch
No. of poles	16
No. of rows	1
Tightening torque, min.	0.4 Nm
Tightening torque, max.	0.5 Nm
Clamping screw	M 2.5
Stripping length	7 mm
L1 in mm	76.2 mm
L1 in inch	3 inch

Product catalogue | PCB connection systems | PCB plug-in connectors | Pitch 5.00 / 5.08 mm (0.197 / 0.200 inch) | Plug connectors, tension clamp connection, pitch 5.00/5.08 | SLS 5.08 | SLS 5.08/180B

System parameters

Electric shock protection to DIN VDE 0470 Finger-safe plugged/ back-of-hand-safe unplugged

Material data

Insulating material PBT
 Colour orange
 colour chart Similar to RAL 2000
 Insulating material group IIIa
 Flammability class UL 94 V-0
 CTI >= 200
 Contact base material CuSn
 Contact surface tinned

Connectable conductors

Clamping range, min. 0.13 mm²
 Clamping range, max. 3.31 mm²
 AWG, min. 26
 AWG, max. 12
 Solid, min. H05(07) V-U 0.2 mm²
 Solid, max. H05(07) V-U 2.5 mm²
 Flexible, min. H05(07) V-K 0.2 mm²
 Flexible, max. H05(07) V-K 2.5 mm²
 With wire end ferrule, acc. to DIN 46 228/1, min. 0.2 mm²
 With wire end ferrule, acc. to DIN 46 228/1, max. 2.5 mm²
 w. plastic collar ferrule, DIN 46228 pt 4, min. 0.2 mm²
 w. plastic collar ferrule, DIN 46228 pt 4, max. 2.5 mm²
 Gauge to EN 60999 a x b; ø 2.8 mm x 2.0 mm; 2.4 mm

DIN IEC rating data

Rated current, min. No. pins (Tu=20°C) 21.5 A
 Rated current, max. No. pins (Tu=20°C) 16 A
 Rated current, min. No. pins (Tu=40°C) 18 A
 Rated current, max. No. pins (Tu=40°C) 14 A
 Rated voltage for overvoltage class/pollution severity II/2 400 V
 Rated voltage for overvoltage class/pollution severity III/2 320 V
 Rated voltage for overvoltage class/pollution severity III/3 250 V
 Rated impulse withstand voltage for overvoltage class/pollution severity II/2 4 kV
 Rated impulse withstand voltage for overvoltage class/pollution severity III/2 4 kV
 Rated impulse withstand voltage for overvoltage class/pollution severity III/3 4 kV
 Short-time withstand current resistance 3 x 1s with 120 A

CSA rating data

Rated voltage (Use group D) 300 V
 Rated current (Use group D) 10 A
 AWG conductor (field wiring), min. 26

Product catalogue | PCB connection systems | PCB plug-in connectors | Pitch 5.00 / 5.08 mm (0.197 / 0.200 inch) | Plug connectors, tension clamp connection, pitch 5.00/5.08 | SLS 5.08 | SLS 5.08/180B

CSA rating data

AWG conductor (field wiring), max. 12

UL 1059 rating data

Rated voltage (Use group D) 300 V

Rated current (Use group D) 10 A

AWG conductor, min. 26

AWG conductor, max. 12

Approvals

Approvals institutes



Classifications

ETIM 2.0	NK
ETIM 3.0	EC001284
eClass 4.1	27-26-07-01
eClass 5.0	27-26-07-01
eClass 5.1	27-26-07-04

Similar products

Order No.	Part designation	Version
1627240000	SLS 5.08/2B SN OR	PCB plug-in connector, Male connectors, Clamping yoke connection, Clamping range, max.: 3.31 mm ² , Pitch: 5.08 mm, No. of poles: 2, 180°, Box
1627250000	SLS 5.08/3B SN OR	PCB plug-in connector, Male connectors, Clamping yoke connection, Clamping range, max.: 3.31 mm ² , Pitch: 5.08 mm, No. of poles: 3, 180°, Box
1627260000	SLS 5.08/4B SN OR	PCB plug-in connector, Male connectors, Clamping yoke connection, Clamping range, max.: 3.31 mm ² , Pitch: 5.08 mm, No. of poles: 4, 180°, Box
1627270000	SLS 5.08/5B SN OR	PCB plug-in connector, Male connectors, Clamping yoke connection, Clamping range, max.: 3.31 mm ² , Pitch: 5.08 mm, No. of poles: 5, 180°, Box

Product catalogue | PCB connection systems | PCB plug-in connectors | Pitch 5.00 / 5.08 mm (0.197 / 0.200 inch) | Plug connectors, tension clamp connection, pitch 5.00/5.08 | SLS 5.08 | SLS 5.08/180B

1627280000	SLS 5.08/6B SN OR	PCB plug-in connector, Male connectors, Clamping yoke connection, Clamping range, max.: 3.31 mm ² , Pitch: 5.08 mm, No. of poles: 6, 180°, Box
1627290000	SLS 5.08/7B SN OR	PCB plug-in connector, Male connectors, Clamping yoke connection, Clamping range, max.: 3.31 mm ² , Pitch: 5.08 mm, No. of poles: 7, 180°, Box
1627300000	SLS 5.08/8B SN OR	PCB plug-in connector, Male connectors, Clamping yoke connection, Clamping range, max.: 3.31 mm ² , Pitch: 5.08 mm, No. of poles: 8, 180°, Box
1627310000	SLS 5.08/9B SN OR	PCB plug-in connector, Male connectors, Clamping yoke connection, Clamping range, max.: 3.31 mm ² , Pitch: 5.08 mm, No. of poles: 9, 180°, Box
1627320000	SLS 5.08/10B SN OR	PCB plug-in connector, Male connectors, Clamping yoke connection, Clamping range, max.: 3.31 mm ² , Pitch: 5.08 mm, No. of poles: 10, 180°, Box
1627330000	SLS 5.08/11B SN OR	PCB plug-in connector, Male connectors, Clamping yoke connection, Clamping range, max.: 3.31 mm ² , Pitch: 5.08 mm, No. of poles: 11, 180°, Box
1627340000	SLS 5.08/12B SN OR	PCB plug-in connector, Male connectors, Clamping yoke connection, Clamping range, max.: 3.31 mm ² , Pitch: 5.08 mm, No. of poles: 12, 180°, Box
1627350000	SLS 5.08/13B SN OR	PCB plug-in connector, Male connectors, Clamping yoke connection, Clamping range, max.: 3.31 mm ² , Pitch: 5.08 mm, No. of poles: 13, 180°, Box
1627360000	SLS 5.08/14B SN OR	PCB plug-in connector, Male connectors, Clamping yoke connection, Clamping range, max.: 3.31 mm ² , Pitch: 5.08 mm, No. of poles: 14, 180°, Box
1627370000	SLS 5.08/15B SN OR	PCB plug-in connector, Male connectors, Clamping yoke connection, Clamping range, max.: 3.31 mm ² , Pitch: 5.08 mm, No. of poles: 15, 180°, Box
1645150000	SLS 5.08/17B SN OR	PCB plug-in connector, Male connectors, Clamping yoke connection, Clamping range, max.: 3.31 mm ² , Pitch: 5.08 mm, No. of poles: 17, 180°, Box
1645160000	SLS 5.08/18B SN OR	PCB plug-in connector, Male connectors, Clamping yoke connection, Clamping range, max.: 3.31 mm ² , Pitch: 5.08 mm, No. of poles: 18, 180°, Box
1645170000	SLS 5.08/19B SN OR	PCB plug-in connector, Male connectors, Clamping yoke connection, Clamping range, max.: 3.31 mm ² , Pitch: 5.08 mm, No. of poles: 19, 180°, Box
1645180000	SLS 5.08/20B SN OR	PCB plug-in connector, Male connectors, Clamping yoke connection, Clamping range, max.: 3.31 mm ² , Pitch: 5.08 mm, No. of poles: 20, 180°, Box
1645190000	SLS 5.08/21B SN OR	PCB plug-in connector, Male connectors, Clamping yoke connection, Clamping range, max.: 3.31 mm ² , Pitch: 5.08 mm, No. of poles: 21, 180°, Box
1645200000	SLS 5.08/22B SN OR	PCB plug-in connector, Male connectors, Clamping yoke connection, Clamping range, max.: 3.31 mm ² , Pitch: 5.08 mm, No. of poles: 22, 180°, Box
1645210000	SLS 5.08/23B SN OR	PCB plug-in connector, Male connectors, Clamping yoke connection, Clamping range, max.: 3.31 mm ² , Pitch: 5.08 mm, No. of poles: 23, 180°, Box

Product catalogue | PCB connection systems | PCB plug-in connectors | Pitch 5.00 / 5.08 mm (0.197 / 0.200 inch) | Plug connectors, tension clamp connection, pitch 5.00/5.08 | SLS 5.08 | SLS 5.08/180B

1645220000 SLS 5.08/24B SN OR

PCB plug-in connector, Male connectors, Clamping yoke connection, Clamping range, max.: 3.31 mm², Pitch: 5.08 mm, No. of poles: 24, 180°, Box