

## Excellent Integrated System Limited

Stocking Distributor

Click to view price, real time Inventory, Delivery & Lifecycle Information:

[CUI Inc.](#)  
[SD-30LP](#)

For any questions, you can email us directly:

[sales@integrated-circuit.com](mailto:sales@integrated-circuit.com)

**SERIES:** SD-XXLP | **DESCRIPTION:** STANDARD DIN CONNECTOR

**FEATURES**

- locking
- metal bushing
- strain relief



**PART NUMBER KEY**

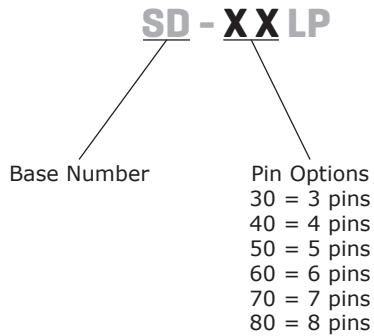

**SPECIFICATIONS**

parameter	conditions/description	min	typ	max	units
rated input voltage			100		Vac
rated input current				2	A
contact resistance				20	mΩ
insulation resistance	at 500 Vdc	100			MΩ
voltage withstand	at 50/60Hz for 1 minute			1000	Vac
operating temperature		-40		85	°C
RoHS	2011/65/EU				

## MECHANICAL DRAWINGS

units: mm[inches]

TOLERANCE: ±0.2mm

	MATERIAL	PLATING
contact terminals	brass	silver
clip plate	cold rolled steel	nickel
body/nut	zinc alloy	nickel
screw	steel	nickel
body	zinc alloy	nickel
strain relief	PVC	
plastic core	nylon	

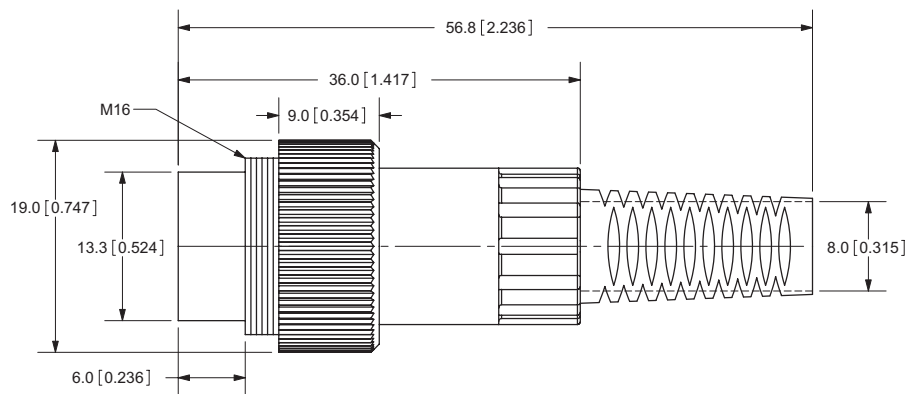
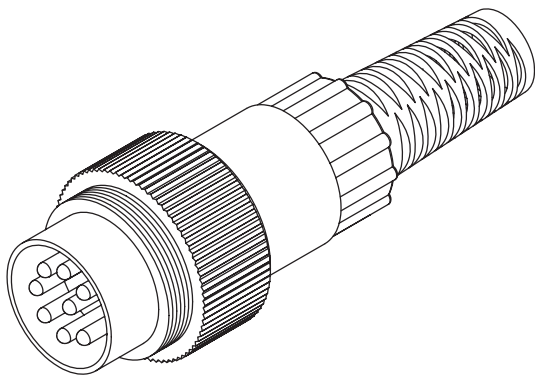

### SD-30LP

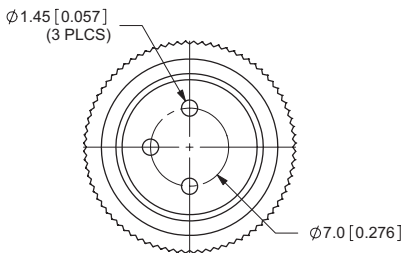

### SD-40LP

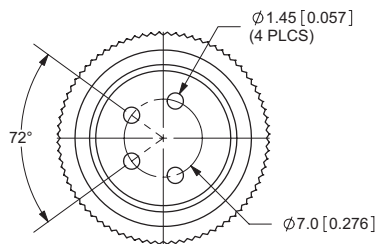

### SD-50LP

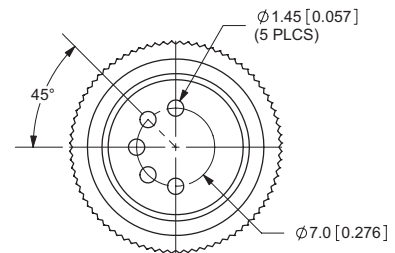

### SD-60LP

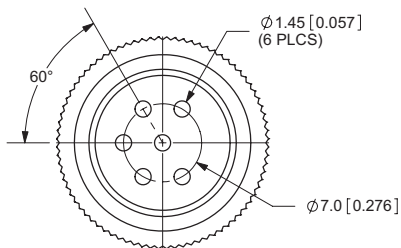

### SD-70LP

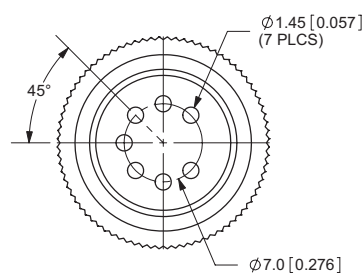

### SD-80LP

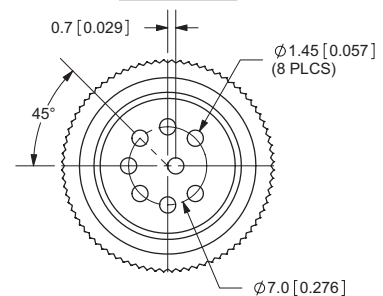



## REVISION HISTORY

rev.	description	date
1.0	initial release	02/23/2006
1.01	new template applied	02/07/2012
1.02	updated datasheet	11/24/2015

The revision history provided is for informational purposes only and is believed to be accurate.



**CUI INC**<sup>®</sup>

**Headquarters**

20050 SW 112th Ave.  
Tualatin, OR 97062  
**800.275.4899**

Fax 503.612.2383  
**cui.com**  
[techsupport@cui.com](mailto:techsupport@cui.com)

CUI offers a one (1) year limited warranty. Complete warranty information is listed on our website.

CUI reserves the right to make changes to the product at any time without notice. Information provided by CUI is believed to be accurate and reliable. However, no responsibility is assumed by CUI for its use, nor for any infringements of patents or other rights of third parties which may result from its use.

CUI products are not authorized or warranted for use as critical components in equipment that requires an extremely high level of reliability. A critical component is any component of a life support device or system whose failure to perform can be reasonably expected to cause the failure of the life support device or system, or to affect its safety or effectiveness.