

Excellent Integrated System Limited

Stocking Distributor

Click to view price, real time Inventory, Delivery & Lifecycle Information:

[Comchip Technology](#)
[ACDSV6-4448TI-G](#)

For any questions, you can email us directly:

sales@integrated-circuit.com

Small Signal Switching Diodes

ACDSV6-4448TI-G

Reverse Voltage: 80 Volts
Forward Current: 100 mA
RoHS Device

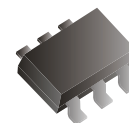

Features

- Design for mounting on small surface.
- High speed switching.
- High mounting capability, strong surge withstand, high reliability.
- Comply with AEC-Q101.

Mechanical data

- Case: SOT-363, molded plastic.
- Terminals: solderable per MIL-STD-750, method 2026.
- Approx. weight: 0.006 grams

Circuit diagram

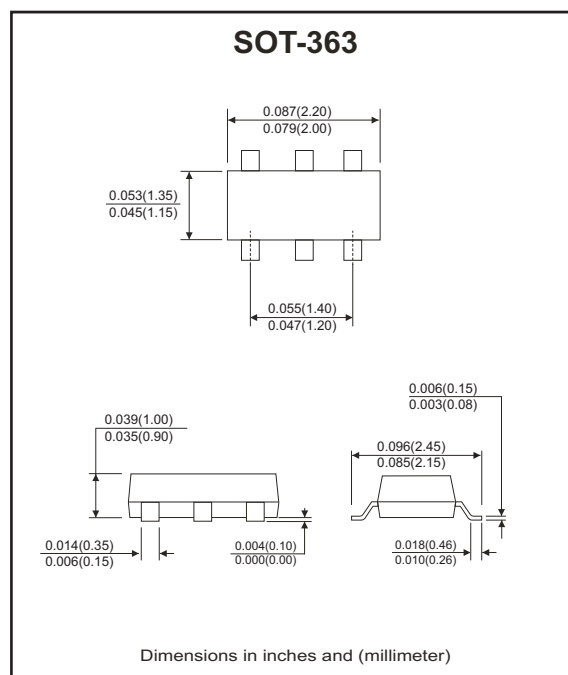
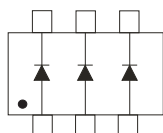

Maximum Ratings and Electrical Characteristics

(at Ta=25°C unless otherwise noted)

Parameter	Symbol	Conditions	Value	Units
Repetitive peak reverse voltage	V _{RRM}		80	V
DC blocking voltage	V _R		80	V
Forward current	I _F		100	mA
Peak surge forward current	I _{FSM}	T=1.0 μS	2	A
Power dissipation	P _D		200	mW
Maximum forward voltage	V _F	@I _F =1mA @I _F =10mA @I _F =100mA	0.72 0.855 1.0	V
Maximum reverse current	I _R	@V _R =20V @V _R =75V @V _R =25V, T _J =150 °C @V _R =75V, T _J =150 °C	0.025 0.1 30 50	μA
Maximum reverse recovery time	T _{rr}	I _F = I _R = 10mA I _{rr} = 0.1 x I _R , R _L = 100Ω	4	nS
Typical diode capacitance	C _T	V _R =6V, f=1.0MHz	3.5	pF
Maximum junction temperature	T _J		150	°C
Storage temperature	T _{STG}		-55 to +150	°C

Small Signal Switching Diodes



RATING AND CHARACTERISTIC CURVES (ACDSV6-4448TI-G)

Fig.1 - Forward Characteristics

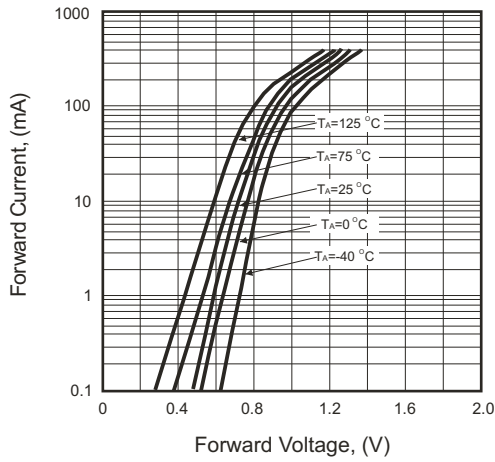

Fig.2 - Reverse Characteristics

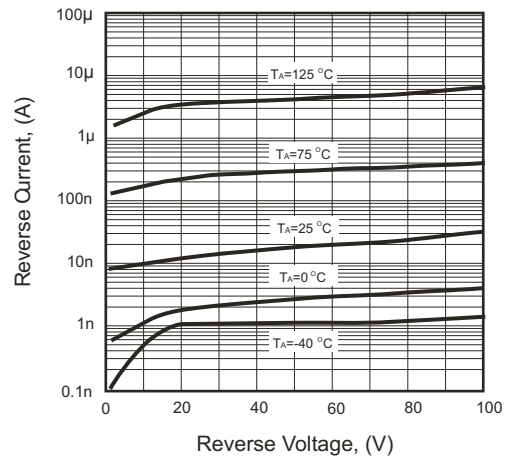

Fig.3 - Capacitance Between Terminals Characteristics

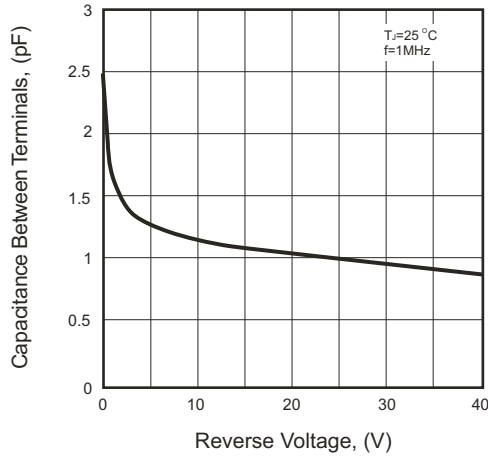
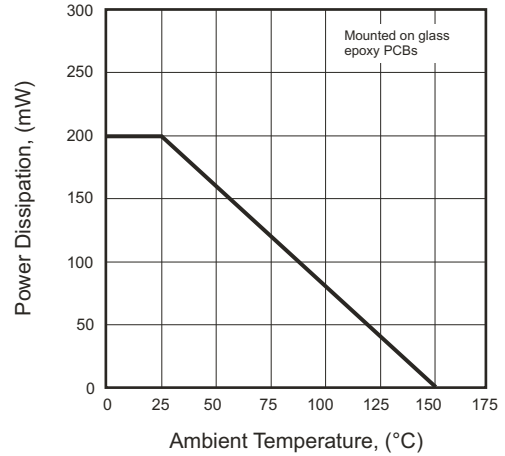

Fig.4 - Power Derating Curve



Small Signal Switching Diodes



Reel Taping Specification

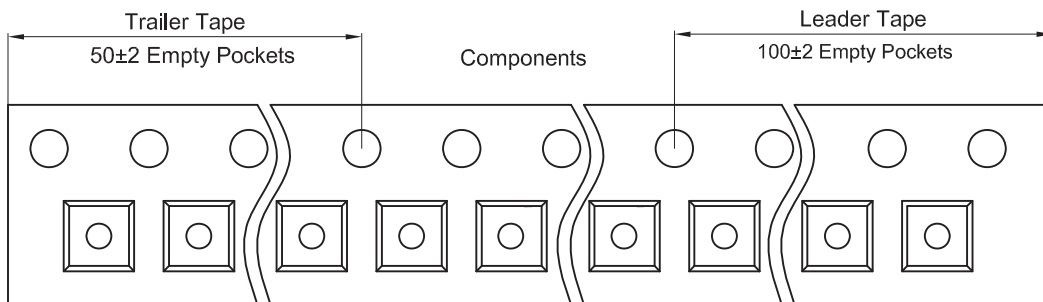
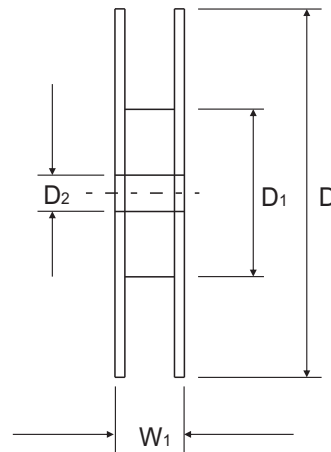
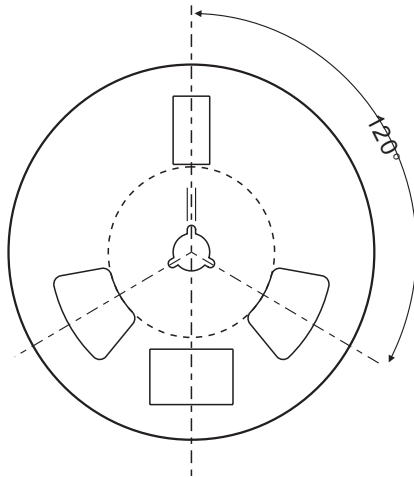
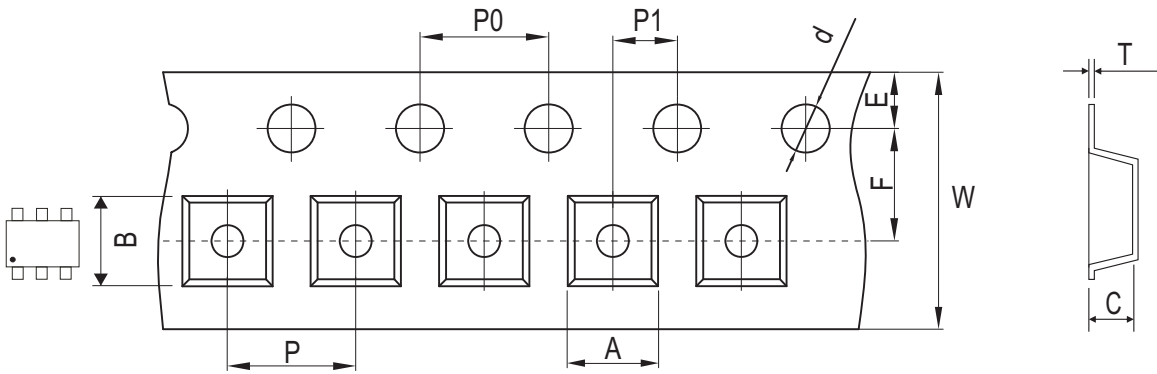

SOT-363	SYMBOL	A	B	C	d	D	D1	D2
	(mm)	2.25 ± 0.05	2.55 ± 0.05	1.20 ± 0.05	1.50 ± 0.10	178 ± 2.00	54.40 ± 1.00	13.00 ± 1.00
	(inch)	0.089 ± 0.002	0.100 ± 0.002	0.047 ± 0.002	0.059 ± 0.004	7.008 ± 0.079	2.142 ± 0.039	0.512 ± 0.039

SOT-363	SYMBOL	E	F	P	P0	P1	W	W1
	(mm)	1.75 ± 0.10	3.50 ± 0.10	4.00 ± 0.10	4.00 ± 0.10	2.00 ± 0.10	8.00 + 0.30 / - 0.10	12.30 ± 1.00
	(inch)	0.069 ± 0.004	0.138 ± 0.004	0.157 ± 0.004	0.157 ± 0.004	0.079 ± 0.004	0.315 + 0.012 / - 0.004	0.484 ± 0.039

Small Signal Switching Diodes

Marking Code

Part Number	Marking Code
ACDSV6-4448TI-G	KAA

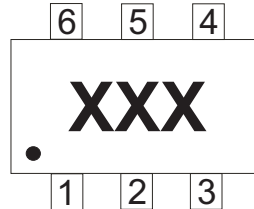

XXX = Product type marking code

Suggested PAD Layout

SIZE	SOT-363	
	(mm)	(inch)
A	0.40	0.016
B	0.80	0.031
C	0.65	0.026
D	1.94	0.076

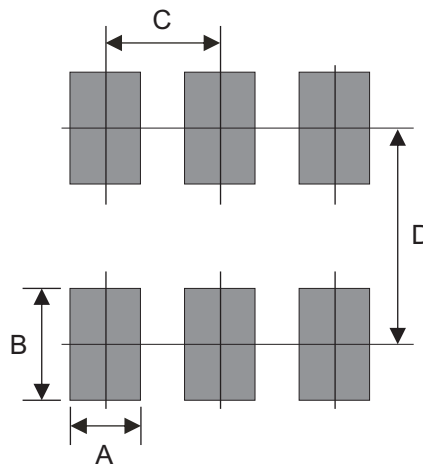

Standard Packaging

Case Type	REEL PACK	
	REEL (pcs)	Reel Size (inch)
SOT-363	3,000	7