

Excellent Integrated System Limited

Stocking Distributor

Click to view price, real time Inventory, Delivery & Lifecycle Information:

[Molex Connector Corporation](#)
[0459704130](#)

For any questions, you can email us directly:
sales@integrated-circuit.com

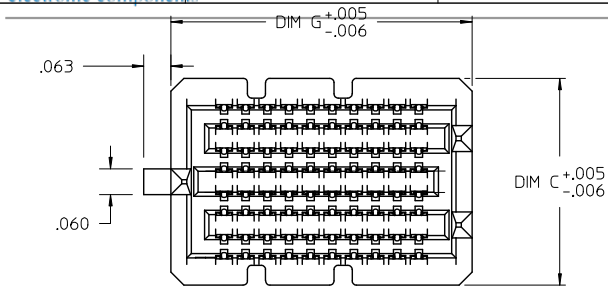

NOTES:

1. MATERIAL: HOUSING: LCP, UL94V-0, BLACK
CONTACTS: COPPER ALLOY
SOLDER CHARGE: TIN, 95.5/ Ag 3.8/ Cu 0.7
2. FINISH: SELECT GOLD IN CONTACT AREA: 30 MICROINCHES MINIMUM
SELECT GOLD FLASH IN TAIL, 7 MICROINCHES MINIMUM OVER NICKEL
3. PRODUCT SPECIFICATION: PS-45970-001
4. PACKAGING SPECIFICATION: TAPE AND REEL PACK, REFERENCE RPK-45971-009
5. MATES WITH SEARAY RECEPTACLE ASSY 45971
6. APPLICATION SPECIFICATION: AS-45970-001
7. COSMETIC SPECIFICATION: PS-45499-002 CLASS B
8. PART STATUS: CONTACT MOLEX

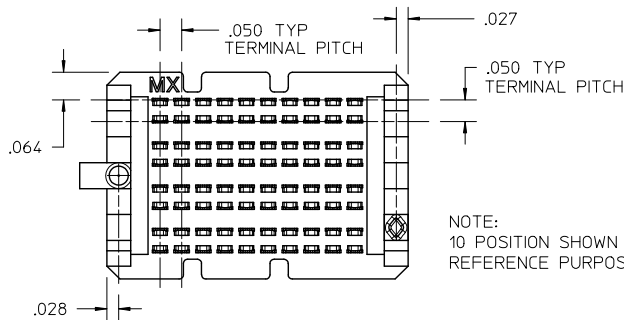
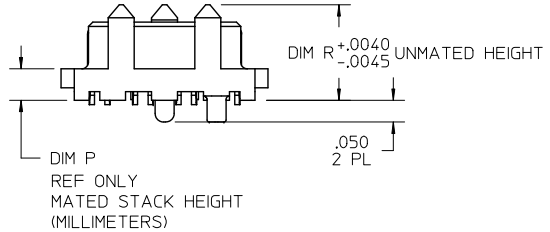
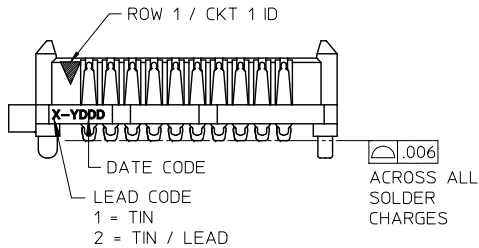

NOTE:
10 POSITION SHOWN FOR
REFERENCE PURPOSES ONLY.

| | |
|------------|--------|
| NO OF ROWS | 8 |
| POSITIONS | 40 |
| DIM C | .478 |
| DIM E | .175 |
| DIM G | 2.196 |
| DIM P | 2.0 MM |
| DIM R | .221 |

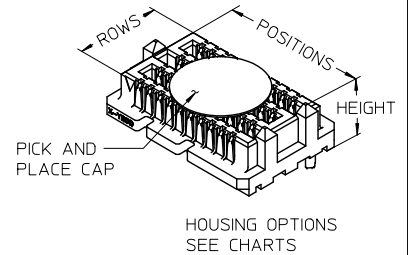

| | | | | | | | | | |
|---|--------------------------------------|---------------------------------------|------|---------------------------|---|-----------------|---|-----------------------------|------------------|
| REV. NOTE 4 TO REF: RPK-45970-009 EC NO: UCP2015-3314 DRWN: SWANG01 CHKD: BBARKER APPR: SMILLER | QUALITY SYMBOLS ▽=0 ▽=0 ▽=0 | GENERAL TOLERANCES (UNLESS SPECIFIED) | | DIMENSION STYLE INCH ONLY | | SCALE 3:1 | DESIGN UNITS INCH | THIRD ANGLE PROJECTION | |
| | | | mm | INCH | DRAWN BY RWHIPPLE | DATE 2014/04/18 | TITLE SEARAY PLUG ASSEMBLY .050 CENTERS molex | | |
| | | 4 PLACES | ±--- | ±--- | CHECKED BY BBARKER | DATE 2014/04/18 | | | |
| | | 3 PLACES | ±--- | ±.010 | APPROVED BY SMILLER | DATE 2014/05/22 | MATERIAL NO. 45970-4130 | DOCUMENT NO. RSD-45970-4130 | SHEET NO. 1 OF 2 |
| | | | | | THIS DRAWING CONTAINS INFORMATION THAT IS PROPRIETARY TO MOLEX INCORPORATED AND SHOULD NOT BE USED WITHOUT WRITTEN PERMISSION | | | | |

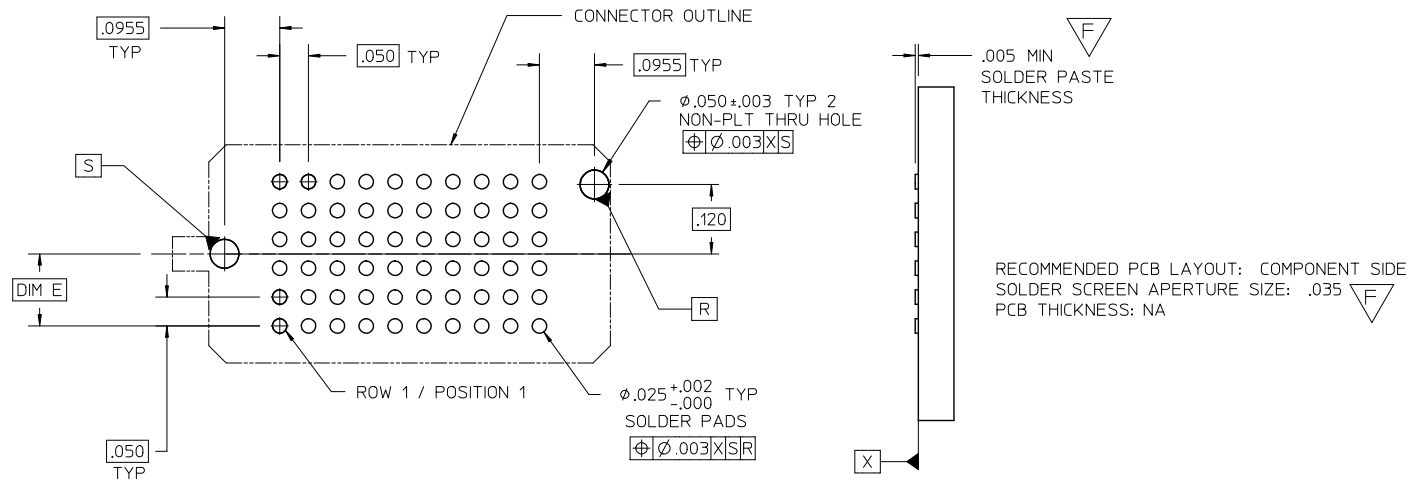

| DIM P PLUG STACK HEIGHT | MM | DIM R RECEPTACLE STACK HEIGHT | | | | |
|----------------------------|-----|----------------------------------|-----|-----|-----|------|
| | | 5.0 | 6.0 | 6.5 | 7.5 | 8.0 |
| | 2.0 | 7.0 | 8.0 | 8.5 | 9.5 | 10.0 |

MATED STACK HEIGHTS
(MILLIMETERS) REF

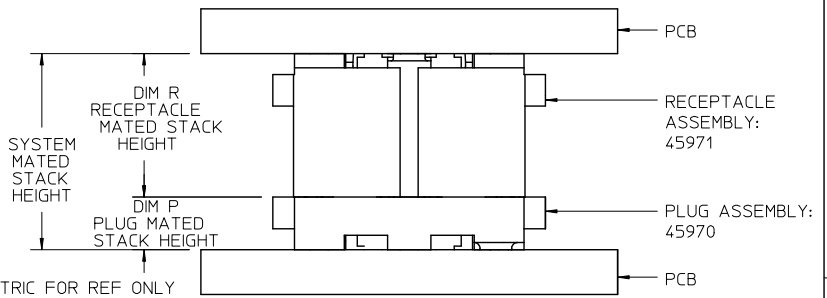

STACK HEIGHTS GIVEN IN METRIC FOR REF ONLY

| | | | | | | | |
|--|-----------------|---------------------------------------|--|-----------------|--------------|---|------------------------|
| SEE SHEET 1 EC NO: UCP2015-3314 DRWN: SVANG01 2015/08/12 CHKD: BBARKER 2015/08/12 APPR: SMILLER 2015/08/14 | QUALITY SYMBOLS | GENERAL TOLERANCES (UNLESS SPECIFIED) | | DIMENSION STYLE | SCALE | DESIGN UNITS | THIRD ANGLE PROJECTION |
| | ▽=0 | mm | INCH | INCH ONLY | 4:1 | INCH | |
| | ▽=0 | 4 PLACES ±--- | ±--- | RWHIPPLE | 2014/04/18 | TITLE | |
| | ▽=0 | 3 PLACES ±--- | ±.010 | CHECKED BY | DATE | SEARAY PLUG ASSEMBLY .050 CENTERS molex | |
| | ▽=0 | 2 PLACES ±--- | ±.015 | BBARKER | 2014/04/18 | | |
| | 1 PLACE ±--- | ±--- | APPROVED BY | DATE | MATERIAL NO. | DOCUMENT NO. | SHEET NO. |
| | 0 PLACE ± | ± | SMILLER | 2014/05/22 | SEE SHEET 1 | RSD-45970-4130 | 2 OF 2 |
| | | ANGULAR ±---° | DRAFT WHERE APPLICABLE MUST REMAIN WITHIN DIMENSIONS | | | | |