

Excellent Integrated System Limited

Stocking Distributor

Click to view price, real time Inventory, Delivery & Lifecycle Information:

[International Rectifier \(Infineon Technologies Americas Corp.\)
IRF6604](#)

For any questions, you can email us directly:

sales@integrated-circuit.com

International IOR Rectifier

- Application Specific MOSFETs
- Ideal for CPU Core DC-DC Converters
- Low Conduction Losses
- Low Switching Losses
- Low Profile (<0.7 mm)
- Dual Sided Cooling Compatible
- Compatible with existing Surface Mount Techniques

PD - 94365E

IRF6604

HEXFET® Power MOSFET

| V _{DSS} | R _{DS(on)} max | Qg |
|------------------|---------------------------------|------|
| 30V | 11.5mΩ @ V _{GS} = 7.0V | 17nC |
| | 13mΩ @ V _{GS} = 4.5V | |

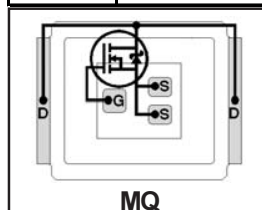

Applicable DirectFET Outline and Substrate Outline (see p.9,10 for details)

| | | | | | | | | | |
|----|----|----|-----------|----|----|--|--|--|--|
| SQ | SX | ST | MQ | MX | MT | | | | |
|----|----|----|-----------|----|----|--|--|--|--|

Description

The IRF6604 combines the latest HEXFET® Power MOSFET Silicon technology with the advanced DirectFET™ packaging to achieve the lowest on-state resistance charge product in a package that has the footprint of an SO-8 and only 0.7 mm profile. The DirectFET package is compatible with existing layout geometries used in power applications, PCB assembly equipment and vapor phase, infra-red or convection soldering techniques, when application note AN-1035 is followed regarding the manufacturing methods and process. The DirectFET package allows dual sided cooling to maximize thermal transfer in power systems, IMPROVING previous best thermal resistance by 80%.

The IRF6604 balances both low resistance and low charge along with ultra low package inductance to reduce both conduction and switching losses. The reduced total losses make this product ideal for high efficiency DC-DC converters that power the latest generation of processors operating at higher frequencies. The IRF6604 has been optimized for parameters that are critical in synchronous buck converters including Rds(on) and gate charge to minimize losses in the control FET socket.

Absolute Maximum Ratings

| | Parameter | Max. | Units |
|--|--|--------------|-------|
| V _{DS} | Drain-to-Source Voltage | 30 | V |
| V _{GS} | Gate-to-Source Voltage | ±12 | |
| I _D @ T _C = 25°C | Continuous Drain Current, V _{GS} @ 7.0V | 49 | A |
| I _D @ T _A = 25°C | Continuous Drain Current, V _{GS} @ 7.0V | 12 | |
| I _D @ T _A = 70°C | Continuous Drain Current, V _{GS} @ 7.0V | 9.2 | |
| I _{DM} | Pulsed Drain Current ① | 92 | |
| P _D @ T _A = 25°C | Power Dissipation ⑤ | 2.3 | W |
| P _D @ T _A = 70°C | Power Dissipation ⑤ | 1.5 | |
| P _D @ T _C = 25°C | Power Dissipation | 42 | |
| | Linear Derating Factor | 0.018 | W/°C |
| T _J | Operating Junction and | -40 to + 150 | °C |
| T _{STG} | Storage Temperature Range | | |

Thermal Resistance

| | Parameter | Typ. | Max. | Units |
|---------------------|-------------------------|------|------|-------|
| R _{θJA} | Junction-to-Ambient ④③ | — | 55 | °C/W |
| R _{θJA} | Junction-to-Ambient ⑤③ | 12.5 | — | |
| R _{θJA} | Junction-to-Ambient ⑥③ | 20 | — | |
| R _{θJC} | Junction-to-Case ⑦③ | — | 3.0 | |
| R _{θJ-PCB} | Junction-to-PCB Mounted | 1.0 | — | |

Notes ① through ③ are on page 11
www.irf.com

IRF6604

International
IR Rectifier

Static @ $T_J = 25^\circ\text{C}$ (unless otherwise specified)

| | Parameter | Min. | Typ. | Max. | Units | Conditions |
|--------------------------------|--|------|------|------|-------|---|
| BV_{DSS} | Drain-to-Source Breakdown Voltage | 30 | — | — | V | $V_{GS} = 0V, I_D = 250\mu A$ |
| $\Delta BV_{DSS}/\Delta T_J$ | Breakdown Voltage Temp. Coefficient | — | 27 | — | mV/°C | Reference to $25^\circ\text{C}, I_D = 1mA$ |
| $R_{DS(on)}$ | Static Drain-to-Source On-Resistance | — | 9.0 | 11.5 | mΩ | $V_{GS} = 7.0V, I_D = 12A$ ③ |
| | | — | 10 | 13 | | $V_{GS} = 4.5V, I_D = 9.6A$ ③ |
| $V_{GS(th)}$ | Gate Threshold Voltage | 1.3 | — | 2.1 | V | $V_{DS} = V_{GS}, I_D = 250\mu A$ |
| $\Delta V_{GS(th)}/\Delta T_J$ | Gate Threshold Voltage Coefficient | — | -4.5 | — | mV/°C | |
| I_{DSS} | Drain-to-Source Leakage Current | — | — | 30 | μA | $V_{DS} = 24V, V_{GS} = 0V$ |
| | | — | — | 50 | μA | $V_{DS} = 30V, V_{GS} = 0V$ |
| | | — | — | 100 | | $V_{DS} = 24V, V_{GS} = 0V, T_J = 125^\circ\text{C}$ |
| I_{GSS} | Gate-to-Source Forward Leakage | — | — | 100 | nA | $V_{GS} = 12V$ |
| | Gate-to-Source Reverse Leakage | — | — | -100 | | $V_{GS} = -12V$ |
| g_{fs} | Forward Transconductance | 38 | — | — | S | $V_{DS} = 15V, I_D = 9.6A$ |
| Q_g | Total Gate Charge | — | 17 | 26 | nC | $V_{DS} = 15V$ $V_{GS} = 4.5V$ $I_D = 9.6A$ See Fig. 16 |
| Q_{gs1} | Pre-V _{th} Gate-to-Source Charge | — | 4.1 | — | | |
| Q_{gs2} | Post-V _{th} Gate-to-Source Charge | — | 1.0 | — | | |
| Q_{gd} | Gate-to-Drain Charge | — | 6.3 | — | | |
| Q_{godr} | Gate Charge Overdrive | — | 5.6 | — | | |
| Q_{sw} | Switch Charge ($Q_{gs2} + Q_{gd}$) | — | 7.3 | — | | |
| Q_{oss} | Output Charge | — | 9.5 | — | nC | $V_{DS} = 16V, V_{GS} = 0V$ |
| R_G | Gate Resistance | — | 1.1 | 2.0 | Ω | |
| $t_{d(on)}$ | Turn-On Delay Time | — | 11 | — | ns | $V_{DD} = 15V, V_{GS} = 4.5V$ ③ $I_D = 9.6A$ Clamped Inductive Load |
| t_r | Rise Time | — | 4.3 | — | | |
| $t_{d(off)}$ | Turn-Off Delay Time | — | 18 | — | | |
| t_f | Fall Time | — | 25 | — | | |
| C_{iss} | Input Capacitance | — | 2270 | — | pF | $V_{GS} = 0V$ $V_{DS} = 15V$ $f = 1.0MHz$ |
| C_{oss} | Output Capacitance | — | 420 | — | | |
| C_{rss} | Reverse Transfer Capacitance | — | 190 | — | | |

Avalanche Characteristics

| | Parameter | Typ. | Max. | Units |
|----------|--|------|------|-------|
| E_{AS} | Single Pulse Avalanche Energy ^② | — | 32 | mJ |
| I_{AR} | Avalanche Current ① | — | 9.6 | A |
| E_{AR} | Repetitive Avalanche Energy ① | — | 0.23 | mJ |

Diode Characteristics

| | Parameter | Min. | Typ. | Max. | Units | Conditions |
|----------|---|------|------|------|-------|---|
| I_S | Continuous Source Current (Body Diode) | — | — | 42 | A | MOSFET symbol showing the integral reverse p-n junction diode. |
| I_{SM} | Pulsed Source Current (Body Diode) ① | — | — | 92 | | |
| V_{SD} | Diode Forward Voltage | — | 0.94 | 1.2 | V | $T_J = 25^\circ\text{C}, I_S = 9.6A, V_{GS} = 0V$ ③ |
| t_{rr} | Reverse Recovery Time | — | 31 | 47 | ns | $T_J = 25^\circ\text{C}, I_F = 9.6A$ |
| Q_{rr} | Reverse Recovery Charge | — | 26 | 39 | nC | $di/dt = 100A/\mu s$ ③ |

International
IR Rectifier

IRF6604

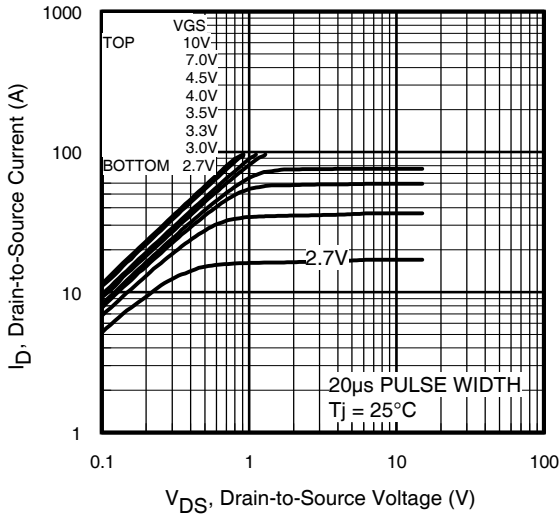

Fig 1. Typical Output Characteristics

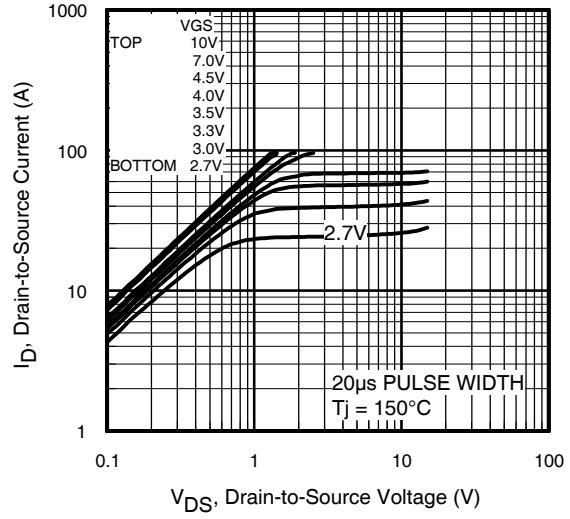

Fig 2. Typical Output Characteristics

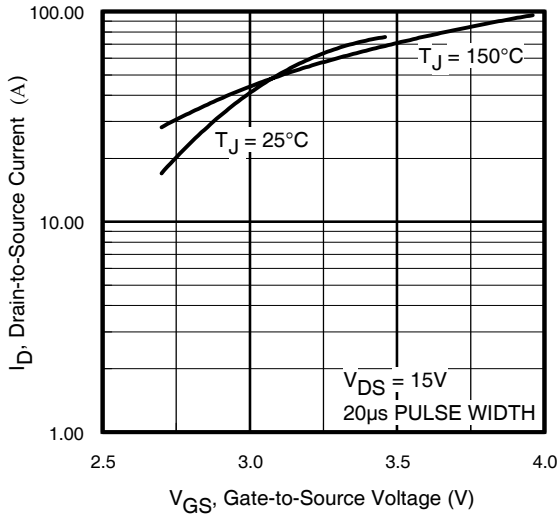

Fig 3. Typical Transfer Characteristics

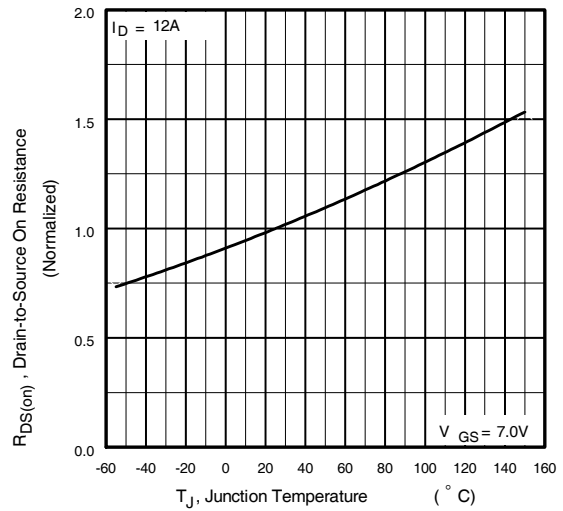

Fig 4. Normalized On-Resistance Vs. Temperature

IRF6604

International
IR Rectifier

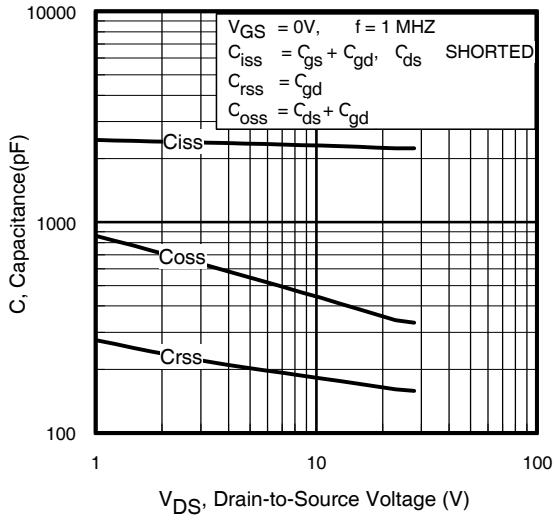

Fig 5. Typical Capacitance Vs. Drain-to-Source Voltage

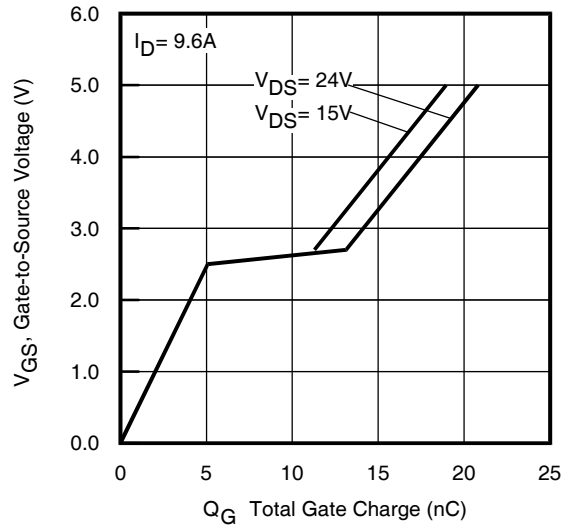

Fig 6. Typical Gate Charge Vs. Gate-to-Source Voltage

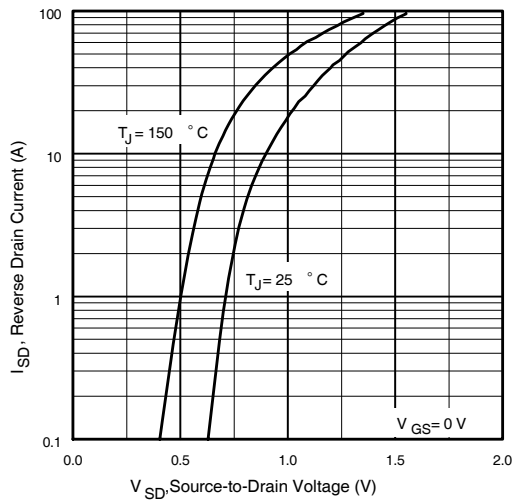

Fig 7. Typical Source-Drain Diode Forward Voltage

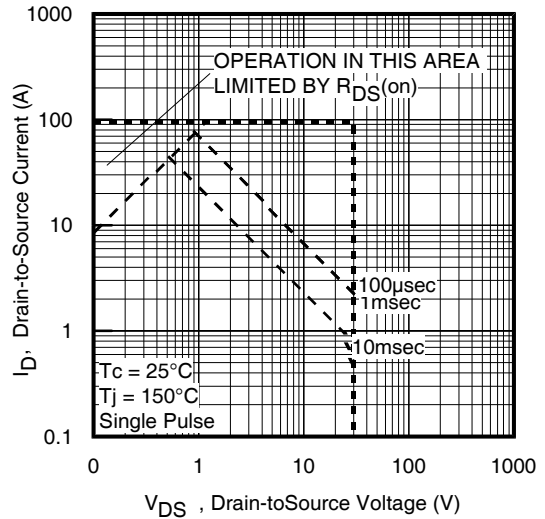

Fig 8. Maximum Safe Operating Area

International
IR Rectifier

IRF6604

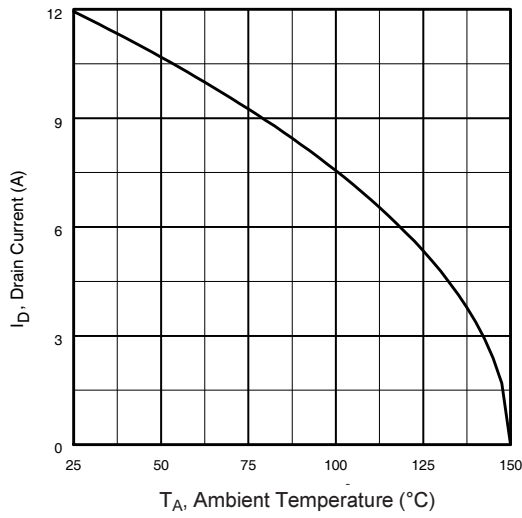

Fig 9. Maximum Drain Current Vs. Ambient Temperature

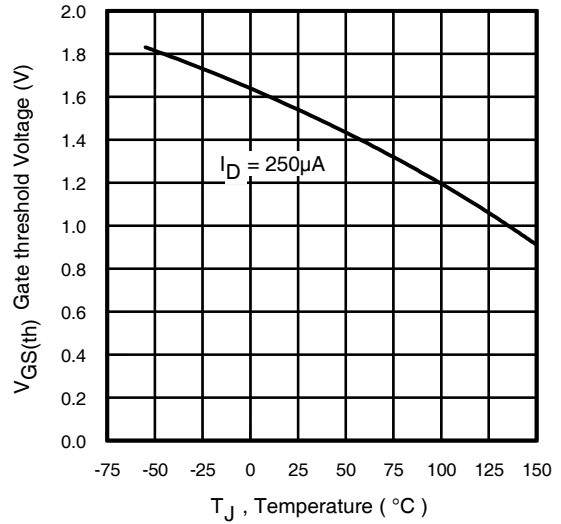

Fig 10. Threshold Voltage Vs. Temperature

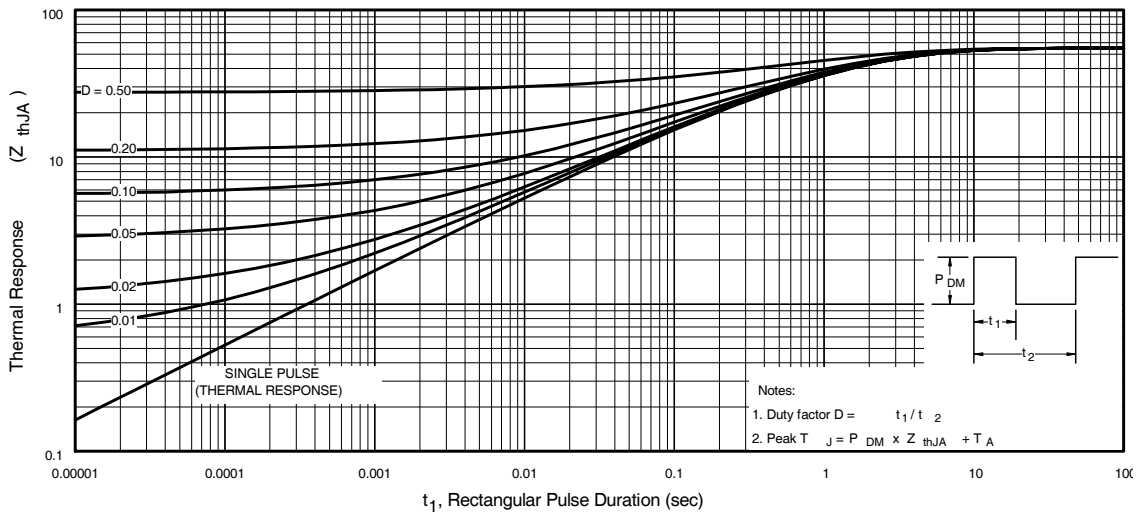

Fig 11. Maximum Effective Transient Thermal Impedance, Junction-to-Ambient

IRF6604

International
IR Rectifier

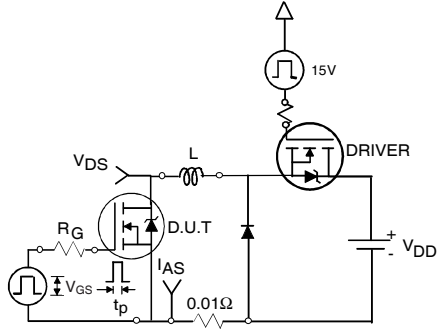

Fig 12a. Unclamped Inductive Test Circuit

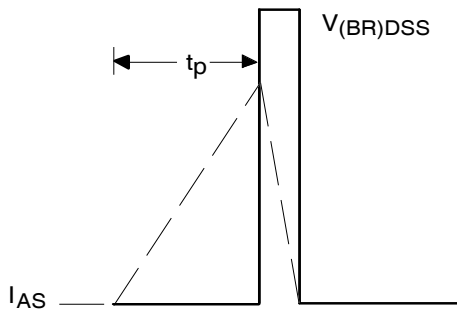

Fig 12b. Unclamped Inductive Waveforms

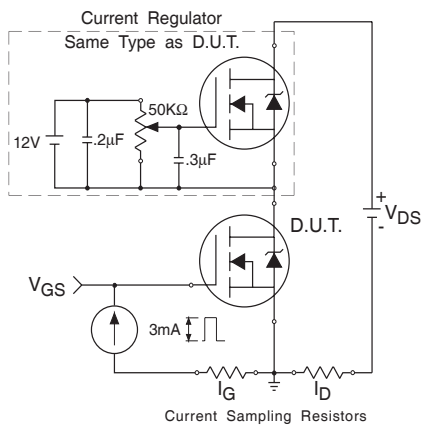

Fig 13. Gate Charge Test Circuit

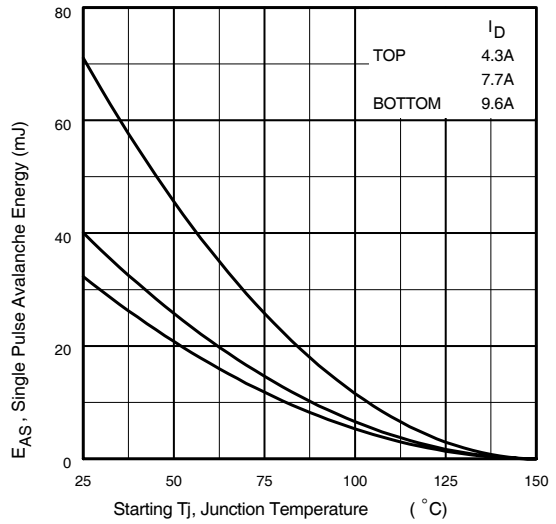

Fig 12c. Maximum Avalanche Energy Vs. Drain Current

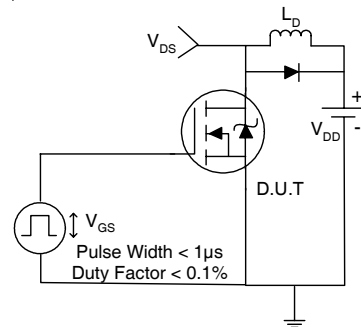

Fig 14a. Switching Time Test Circuit

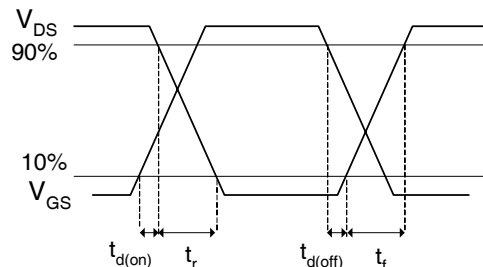

Fig 14b. Switching Time Waveforms

International
IR Rectifier

IRF6604

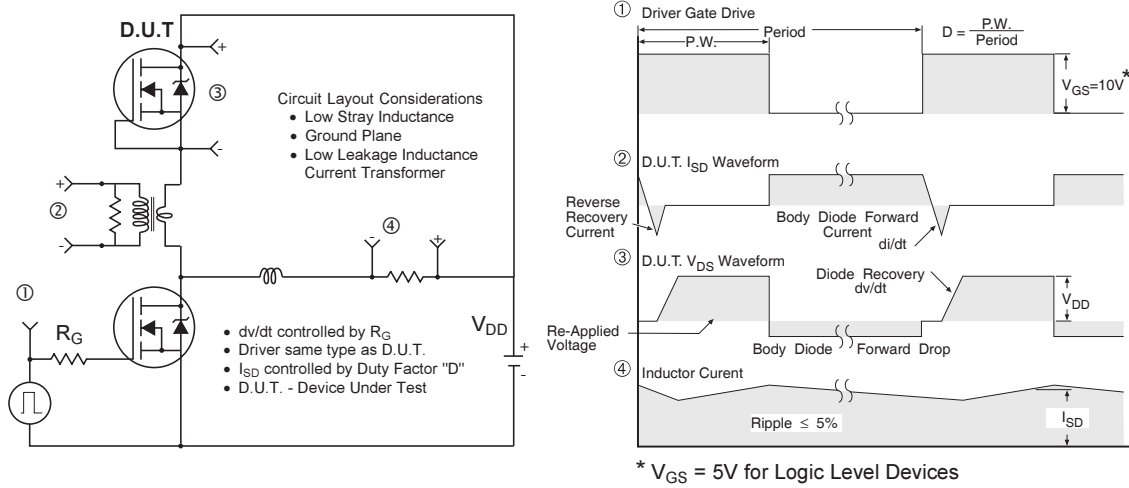

Fig 15. Peak Diode Recovery dv/dt Test Circuit for N-Channel HEXFET® Power MOSFETs

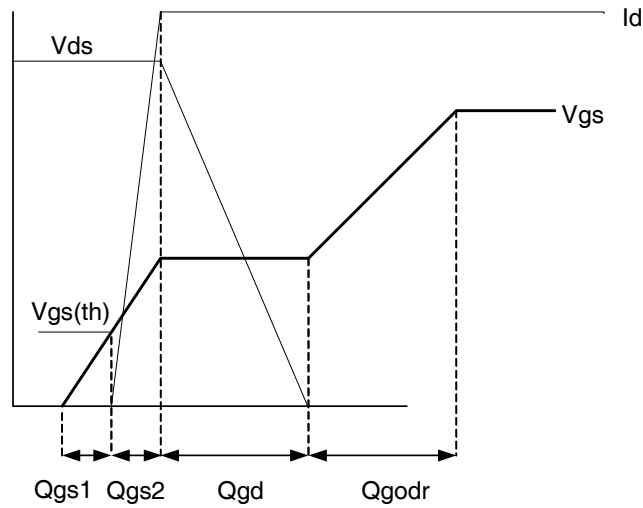

Fig 16. Gate Charge Waveform

IRF6604

International
IR Rectifier

Power MOSFET Selection for Non-Isolated DC/DC Converters

Control FET

Special attention has been given to the power losses in the switching elements of the circuit - Q1 and Q2. Power losses in the high side switch Q1, also called the Control FET, are impacted by the $R_{ds(on)}$ of the MOSFET, but these conduction losses are only about one half of the total losses.

Power losses in the control switch Q1 are given by;

$$P_{loss} = P_{conduction} + P_{switching} + P_{drive} + P_{output}$$

This can be expanded and approximated by;

$$P_{loss} = (I_{rms}^2 \times R_{ds(on)}) + \left(I \times \frac{Q_{gd}}{i_g} \times V_{in} \times f \right) + \left(I \times \frac{Q_{gs2}}{i_g} \times V_{in} \times f \right) + (Q_g \times V_g \times f) + \left(\frac{Q_{oss}}{2} \times V_{in} \times f \right)$$

This simplified loss equation includes the terms Q_{gs2} and Q_{oss} which are new to Power MOSFET data sheets.

Q_{gs2} is a sub element of traditional gate-source charge that is included in all MOSFET data sheets. The importance of splitting this gate-source charge into two sub elements, Q_{gs1} and Q_{gs2} , can be seen from Fig 16.

Q_{gs2} indicates the charge that must be supplied by the gate driver between the time that the threshold voltage has been reached and the time the drain current rises to I_{dmax} at which time the drain voltage begins to change. Minimizing Q_{gs2} is a critical factor in reducing switching losses in Q1.

Q_{oss} is the charge that must be supplied to the output capacitance of the MOSFET during every switching cycle. Figure A shows how Q_{oss} is formed by the parallel combination of the voltage dependant (non-linear) capacitance's C_{ds} and C_{dg} when multiplied by the power supply input buss voltage.

Synchronous FET

The power loss equation for Q2 is approximated by;

$$P_{loss} = P_{conduction} + P_{drive} + P_{output}^*$$

$$P_{loss} = (I_{rms}^2 \times R_{ds(on)}) + (Q_g \times V_g \times f) + \left(\frac{Q_{oss}}{2} \times V_{in} \times f \right) + (Q_{rr} \times V_{in} \times f)$$

*dissipated primarily in Q1.

For the synchronous MOSFET Q2, $R_{ds(on)}$ is an important characteristic; however, once again the importance of gate charge must not be overlooked since it impacts three critical areas. Under light load the MOSFET must still be turned on and off by the control IC so the gate drive losses become much more significant. Secondly, the output charge Q_{oss} and reverse recovery charge Q_{rr} both generate losses that are transferred to Q1 and increase the dissipation in that device. Thirdly, gate charge will impact the MOSFETs' susceptibility to Cdv/dt turn on.

The drain of Q2 is connected to the switching node of the converter and therefore sees transitions between ground and V_{in} . As Q1 turns on and off there is a rate of change of drain voltage dV/dt which is capacitively coupled to the gate of Q2 and can induce a voltage spike on the gate that is sufficient to turn the MOSFET on, resulting in shoot-through current. The ratio of Q_{gd}/Q_{gs1} must be minimized to reduce the potential for Cdv/dt turn on.

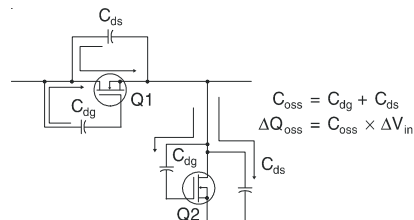

Figure A: Q_{oss} Characteristic

International
IR Rectifier

IRF6604

DirectFET™ Outline Dimension, MQ Outline (Medium Size Can, Q-Designation).

Please see DirectFET application note AN-1035 for all details regarding the assembly of DirectFET.
 This includes all recommendations for stencil and substrate designs.

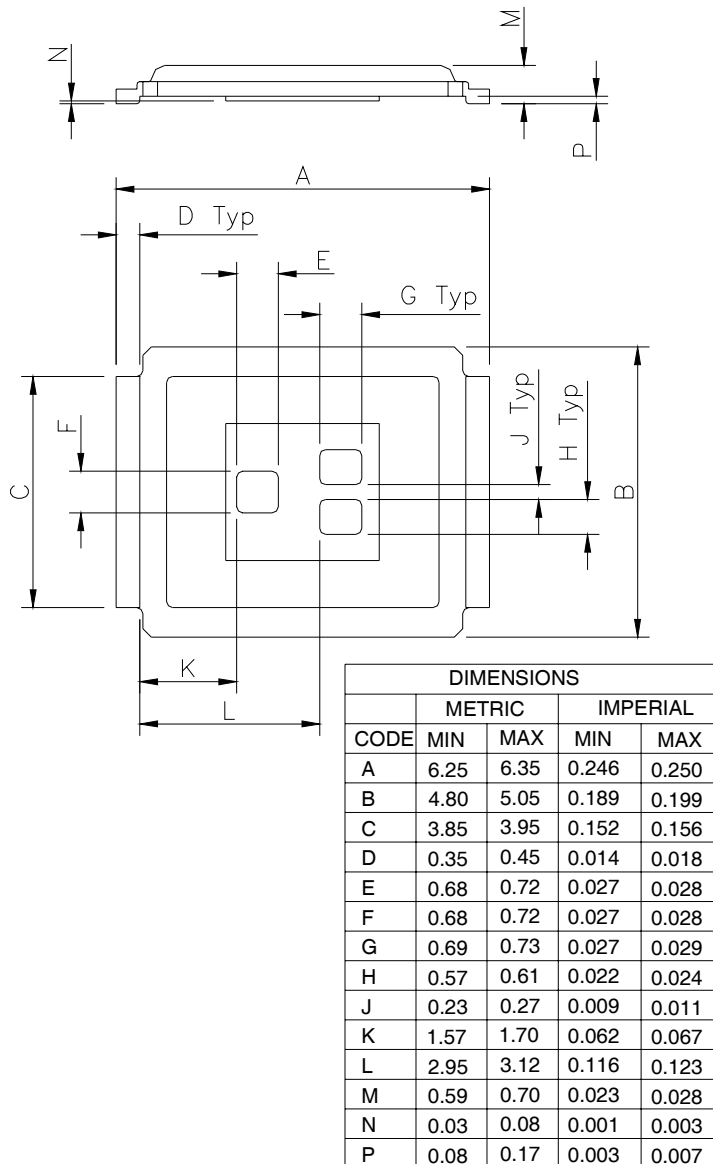

IRF6604

International
IR Rectifier

DirectFET™ Substrate and PCB Layout, MQ Outline (MediumSize Can, Q-Designation).

Please see DirectFET application note AN-1035 for all details regarding the assembly of DirectFET.
 This includes all recommendations for stencil and substrate designs.

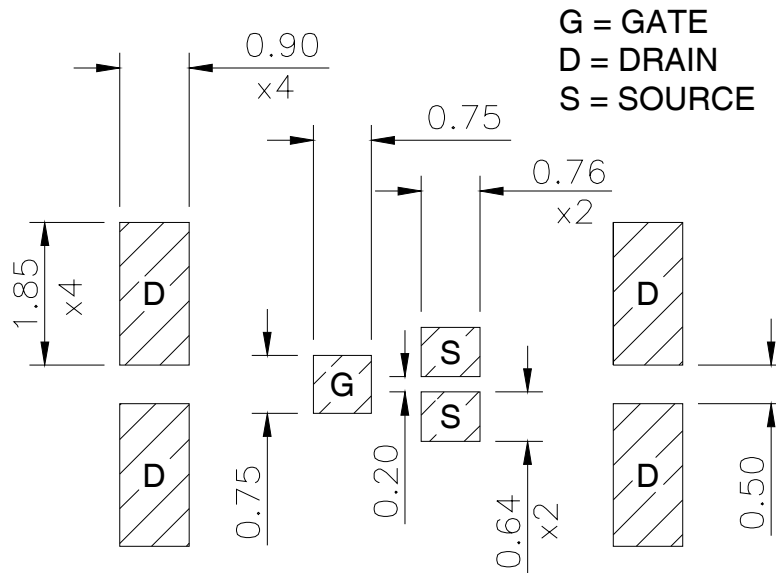
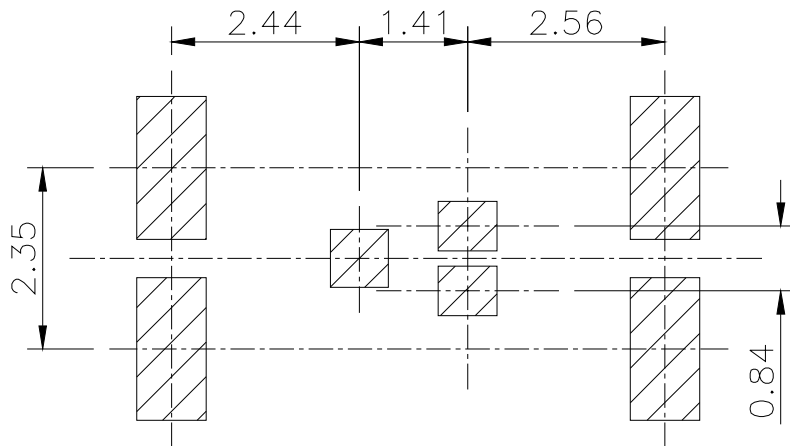

International
IR Rectifier

IRF6604

DirectFET™ Tape & Reel Dimension
(Showing component orientation).

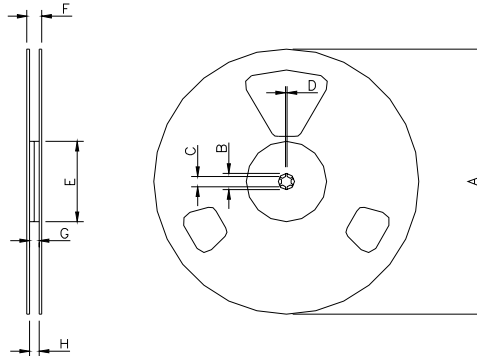

NOTE: Controlling dimensions in mm
 Std reel quantity is 4800 parts. (ordered as IRF6604). For 1000 parts on 7" reel, order IRF6604TR1

| REEL DIMENSIONS | | | | | | | | |
|-----------------|----------------------------|------|----------|-------|-----------------------|-------|----------|------|
| CODE | STANDARD OPTION (QTY 4800) | | | | TR1 OPTION (QTY 1000) | | | |
| | METRIC | | IMPERIAL | | METRIC | | IMPERIAL | |
| A | 330.0 | N.C | 12.992 | N.C | 177.77 | N.C | 6.9 | N.C |
| B | 20.2 | N.C | 0.795 | N.C | 19.06 | N.C | 0.75 | N.C |
| C | 12.8 | 13.2 | 0.504 | 0.520 | 13.5 | 12.8 | 0.53 | 0.50 |
| D | 1.5 | N.C | 0.059 | N.C | 1.5 | N.C | 0.059 | N.C |
| E | 100.0 | N.C | 3.937 | N.C | 58.72 | N.C | 2.31 | N.C |
| F | N.C | 18.4 | N.C | 0.724 | N.C | 13.50 | N.C | 0.53 |
| G | 12.4 | 14.4 | 0.488 | 0.567 | 11.9 | 12.01 | 0.47 | N.C |
| H | 11.9 | 15.4 | 0.469 | 0.606 | 11.9 | 12.01 | 0.47 | N.C |

LOADED TAPE FEED DIRECTION

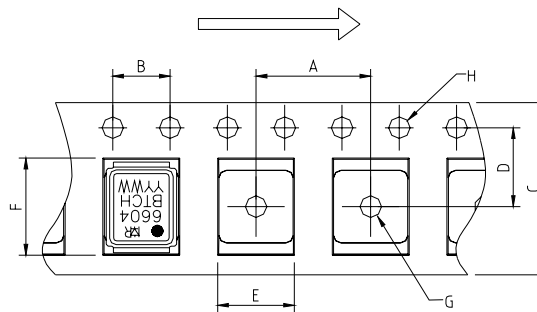

| CODE | DIMENSIONS | | | |
|------|------------|-------|----------|-------|
| | METRIC | | IMPERIAL | |
| A | 7.90 | 8.10 | 0.311 | 0.319 |
| B | 3.90 | 4.10 | 0.154 | 0.161 |
| C | 11.90 | 12.30 | 0.469 | 0.484 |
| D | 5.45 | 5.55 | 0.215 | 0.219 |
| E | 5.10 | 5.30 | 0.201 | 0.209 |
| F | 6.50 | 6.70 | 0.256 | 0.264 |
| G | 1.50 | N.C | 0.059 | N.C |
| H | 1.50 | 1.60 | 0.059 | 0.063 |

IRF6604

International
IR Rectifier

DirectFET™ Part Marking

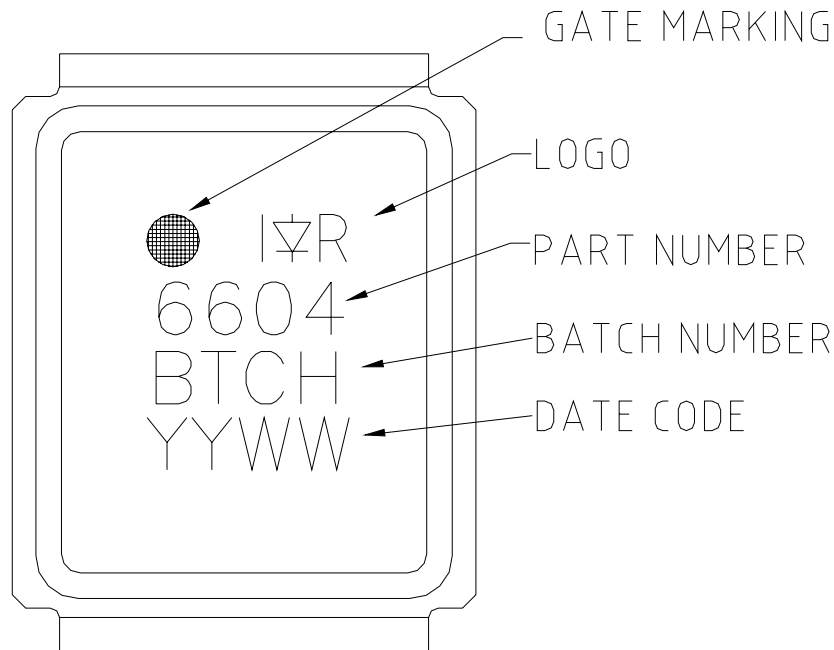

Notes:

- ① Repetitive rating; pulse width limited by max. junction temperature.
- ② Starting $T_J = 25^\circ\text{C}$, $L = 0.70\text{mH}$
 $R_G = 25\Omega$, $I_{AS} = 9.6\text{A}$.
- ③ Pulse width $\leq 400\mu\text{s}$; duty cycle $\leq 2\%$.
- ④ Surface mounted on 1 in. square Cu board.
- ⑤ Used double sided cooling , mounting pad.
- ⑥ Mounted on minimum footprint full size board with metalized back and with small clip heatsink.
- ⑦ T_C measured with thermal couple mounted to top (Drain) of part.
- ⑧ R_θ is measured at T_J of approximately 90°C .

Data and specifications subject to change without notice.
 This product has been designed and qualified for the Consumer market.
 Qualification Standards can be found on IR's Web site.

International
IR Rectifier

IR WORLD HEADQUARTERS: 233 Kansas St., El Segundo, California 90245, USA Tel: (310) 252-7105
 TAC Fax: (310) 252-7903

Visit us at www.irf.com for sales contact information. 11/05

www.irf.com

Note: For the most current drawings please refer to the IR website at:
<http://www.irf.com/package/>