

Excellent Integrated System Limited

Stocking Distributor

Click to view price, real time Inventory, Delivery & Lifecycle Information:

[Lumex, Inc.](#)
[GT-RLSAE350](#)

For any questions, you can email us directly:
sales@integrated-circuit.com

UNCONTROLLED DOCUMENT

PART NUMBER		REV.
GT-RLSAE350		
REV.	E.C.N. NUMBER AND REVISION COMMENTS	DATE

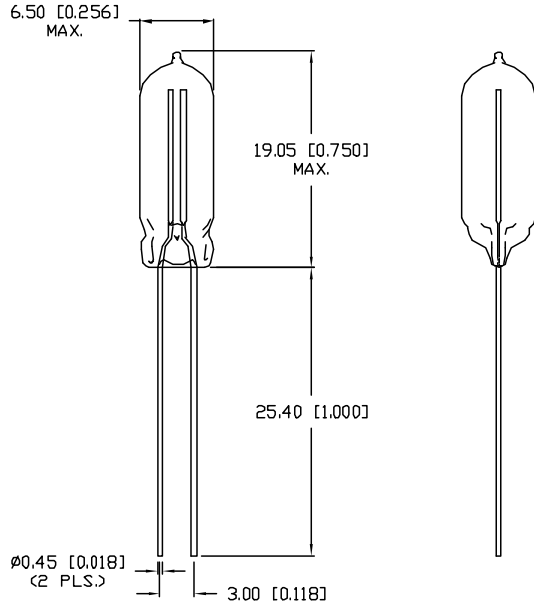

ELECTRICAL SPECIFICATIONS		
CONDITION	SYMBOL	RATING
D.C. FIRING VOLTAGE:	(dv/dt 100V/S)	350±10% VDC
IMPULSE MAX. FIRING VOLTAGE:	(dv/dt 5KV/μS)	1200 VDC
IMPULSE CURRENT (KA):	(8/20μS)	1.5 kA MAX.
IMPULSE SURGE LIFE(X):	(8/20μS 500A)	1000 TIMES MIN.
D.C. HOLDOVER VOLTAGE:	(150ms MAX.)	50 V D.C.
A.C. DISCHARGE CURRENT:	(1S X 5 TIMES)	1 AMP
A.C. FOLLOW-ON CURRENT:	(1/2 CYCLE, 60Hz)	1 AMP
INSULATION RESISTANCE(MIN.):	(100VDC)	10 ^B Ω
INTER-ELECTRODE CAPACITANCE:	(1.0 KHz)	1.0 PF MAX.

ENVIRONMENTAL SPECIFICATIONS PER MIL-STD 202			
TEST	METHOD	CONDITION	RATING
VIBRATION TESTING:	204B	C	C10-55Hz, .06DA
THERMAL SHOCK:	107	B	-65 TO +125°C
HUMIDITY:	103B	B	95% Re. HUMIDITY
TEMP CYCLING:	102A	C	-65 TO +125°C
SOLDERABILITY:	208	B	
OPERATION TEMP.	-	-	-40 TO +100°C

RESPONSE TIME	
SURGE TYPE	(Rt MAX.)
1Kv/mS	1 x 10 ⁻⁵ sec.
1Kv/μS	1 x 10 ⁻⁸ sec.
5Kv/μS	1 x 10 ⁻⁹ sec.

UNCONTROLLED DOCUMENT

*UNLESS OTHERWISE SPECIFIED TOLERANCE IS ±0.25mm (±0.010")

REV.	PART NUMBER GT-RLSAE350	<p>CONFIDENTIAL INFORMATION THE INFORMATION CONTAINED IN THIS DOCUMENT IS THE PROPERTY OF LUMEX INC. EXCEPT AS SPECIFICALLY AUTHORIZED IN WRITING BY LUMEX INC. THE HOLDER OF THIS DOCUMENT SHALL KEEP ALL INFORMATION CONTAINED HEREIN CONFIDENTIAL AND SHALL PROTECT SAME IN WHOLE OR IN PART FROM DISCLOSURE AND DISSEMINATION TO ALL THIRD PARTIES.</p> <p>RELIABILITY NOTE OUR MANY YEARS OF EXPERIENCE DATA ACCUMULATION INDICATE THAT SOLDER HEAT IS A MAJOR CAUSE OF EARLY AND FUTURE FAILURE. PLEASE PAY ATTENTION TO YOUR SOLDERING PROCESS.</p>	<p>LUMEX INCORPORATED 290 E. HELLEN ROAD PALATINE, ILLINOIS 60067 PHONE: 1-847-359-2790 WEB: HTTP://WWW.LUMEX.COM</p>
LIGHT DUTY RADIAL LEAD ARRESTOR, 350VDC.		DRAWN BY: KS/BC CHECKED BY: APPROVED BY: DATE: 6-10-99 PAGE: 1 OF 1 SCALE: N/A	