

## Excellent Integrated System Limited

Stocking Distributor

Click to view price, real time Inventory, Delivery & Lifecycle Information:

[Anaren](#)

[11302-20](#)

For any questions, you can email us directly:

[sales@integrated-circuit.com](mailto:sales@integrated-circuit.com)

**Xinger®**

**Directional Couplers  
20 dB**

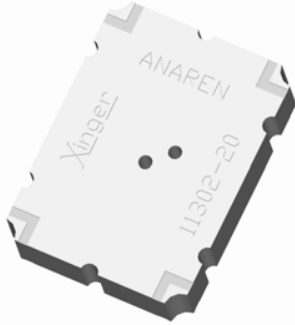

**Description**

The 11302-20 is a low profile 20dB directional coupler in an easy to use surface mount package covering 190 to 400 MHz. The 11302-20 is ideal for power and frequency detection as well as VSWR monitoring and can be used in most high power designs. Parts have been subjected to rigorous qualification testing and units are 100% tested. They are manufactured using materials with x and y thermal expansion coefficients compatible with common substrates such as FR4, G-10 and polyamide.

**Features:**

- 190 - 400 MHz
- Low loss
- High Directivity
- Surface Mountable
- Tape And Reel
- Convenient Package
- 100% Tested

**ELECTRICAL SPECIFICATIONS\*\***

Frequency	Mean Coupling	Insertion Loss	VSWR	Freq. Sensitivity
MHz	dB	dB Max	Max:1	dB Max
190 - 400	20 ± 1.5	0.30	1.15	±0.90
Directivity	Power Handling	⊙JC	Operating Temp.	
dB Min	Watts	°C / Watt	°C	
14	100	5.4	-55 to +85	

\*\*Specification based on performance of unit properly installed on microstrip printed circuit boards with 50 Ω nominal impedance. Specifications subject to change without notice.

**Outline Drawing**

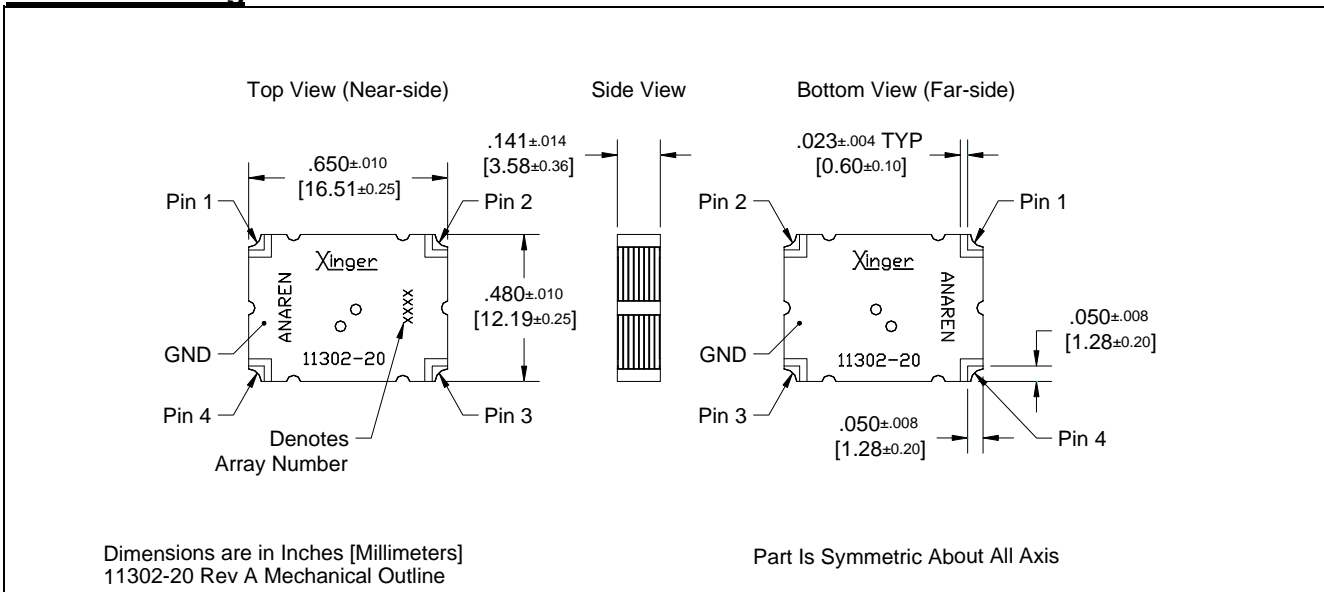

# Model 11302-20

Rev. B

# Anaren

## Xinger®

### Typical Performance: 150 MHz. to 450 MHz.

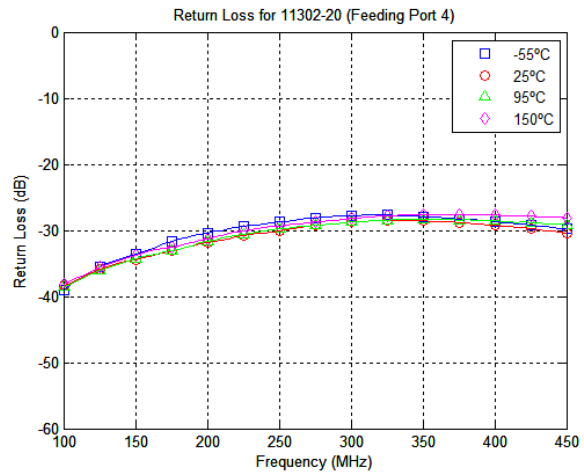
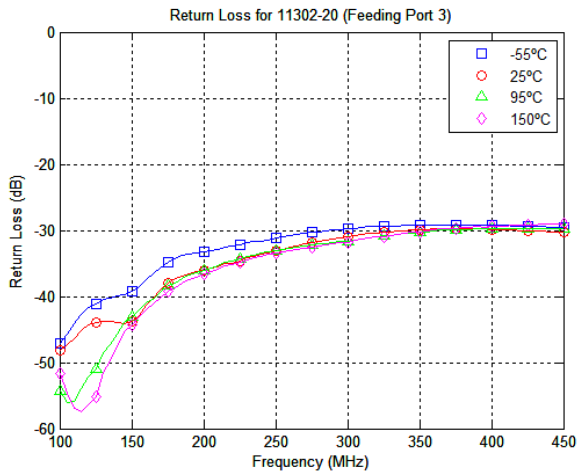
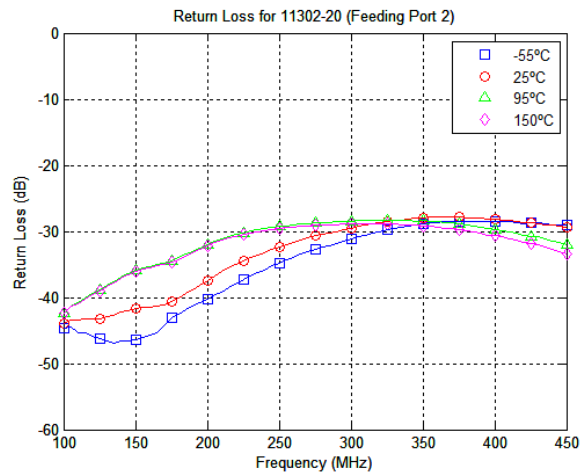
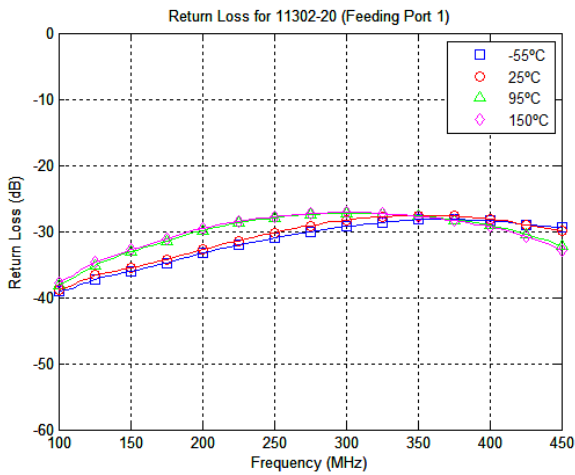

USA/Canada: (315) 432-8909  
 Toll Free: (800) 544-2414  
 Europe: +44 2392-232392

Available on Tape and Reel For Pick and Place Manufacturing.



**Anaren**  
 What'll we think of next



**Typical Performance: 150 MHz. to 450 MHz.**

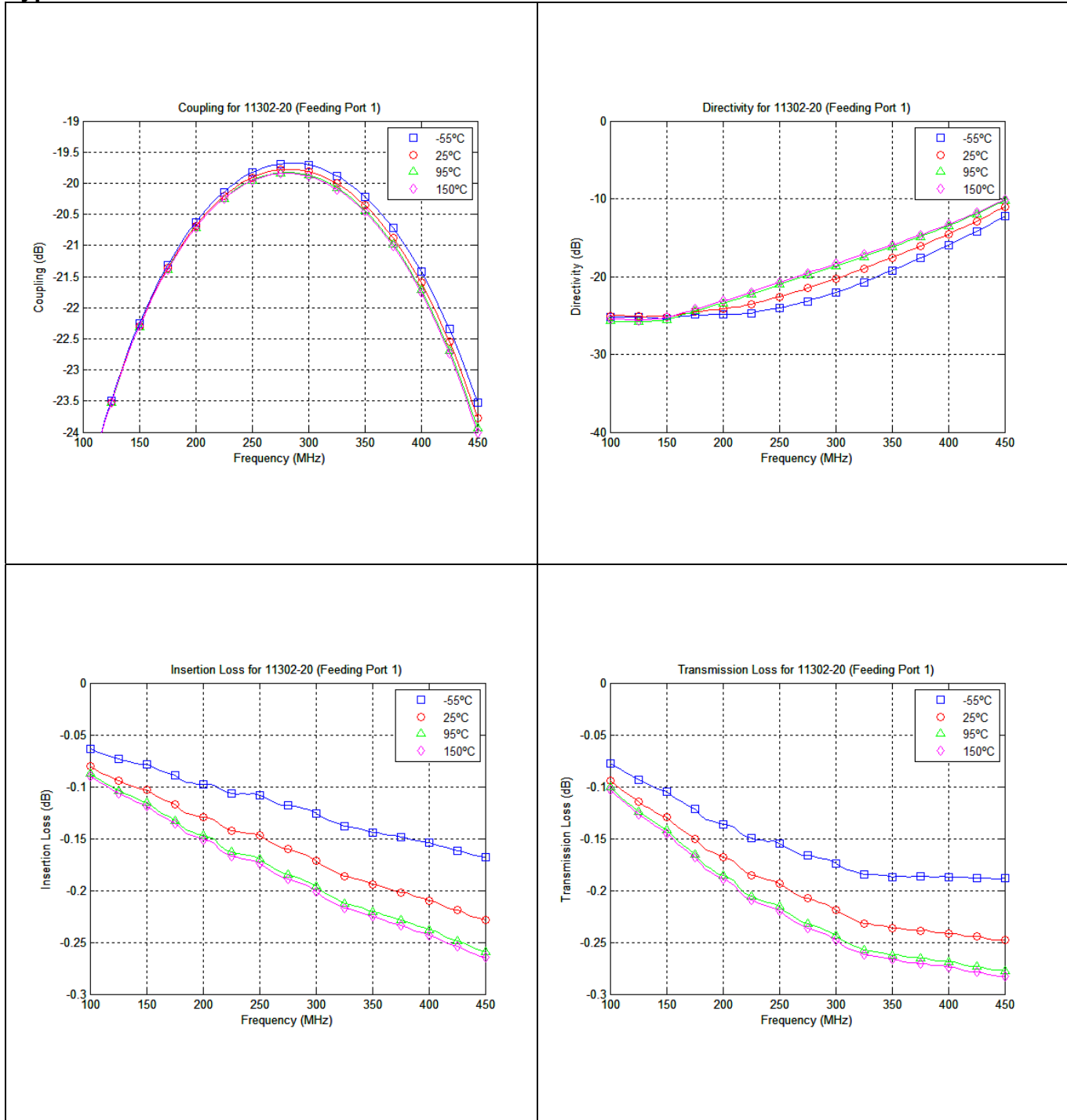



# Model 11302-20

Rev. B

## Pin Configuration

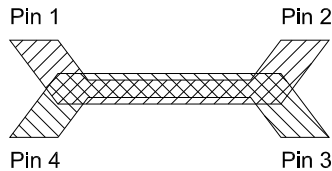

Directional Coupler Pin Configuration				
	Pin 1	Pin 2	Pin 3	Pin 4
Configuration #1	Input	Output	Isolated	Coupled
Configuration #2	Output	Input	Coupled	Isolated
Configuration #3	Isolated	Coupled	Input	Output
Configuration #4	Coupled	Isolated	Output	Input

## Mounting Footprint

To ensure proper electrical and thermal performance there must be a ground plane with 100% solder connection underneath the part

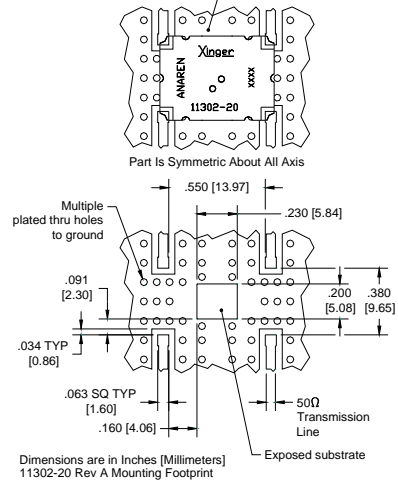

USA/Canada: (315) 432-8909  
 Toll Free: (800) 544-2414  
 Europe: +44 2392-232392

Available on Tape and Reel For Pick and Place Manufacturing.

