

## Excellent Integrated System Limited

Stocking Distributor

Click to view price, real time Inventory, Delivery & Lifecycle Information:

[Texas Instruments](#)

[SN74AVCBH164245GR](#)

For any questions, you can email us directly:

[sales@integrated-circuit.com](mailto:sales@integrated-circuit.com)

## FEATURES

- Member of the Texas Instruments Widebus™ Family
- Dynamic Output Control (DOC™) Circuitry Dynamically Changes Output Impedance, Resulting in Noise Reduction Without Speed Degradation
- Dynamic Drive Capability Is Equivalent to Standard Outputs With  $I_{OH}$  and  $I_{OL}$  of  $\pm 24$  mA at 2.5-V  $V_{CC}$
- Control Inputs  $V_{IH}/V_{IL}$  Levels are Referenced to  $V_{CCB}$  Voltage
- If Either  $V_{CC}$  Input Is at GND, Both Ports Are in the High-Impedance State
- Overvoltage-Tolerant Inputs/Outputs Allow Mixed-Voltage-Mode Data Communications
- $I_{off}$  Supports Partial-Power-Down Mode Operation
- Fully Configurable Dual-Rail Design Allows Each Port to Operate Over the Full 1.4-V to 3.6-V Power-Supply Range
- Bus Hold on Data Inputs Eliminates the Need for External Pullup/Pulldown Resistors
- Latch-Up Performance Exceeds 100 mA Per JESD 78, Class II
- ESD Protection Exceeds JESD 22
  - 2000-V Human-Body Model (A114-A)
  - 200-V Machine Model (A115-A)
  - 1000-V Charged-Device Model (C101)

## DESCRIPTION/ORDERING INFORMATION

This 16-bit (dual-octal) noninverting bus transceiver uses two separate configurable power-supply rails. The A-port is designed to track  $V_{CCA}$ .  $V_{CCA}$  accepts any supply voltage from 1.4 V to 3.6 V. The B-port is designed to track  $V_{CCB}$ .  $V_{CCB}$  accepts any supply voltage from 1.4 V to 3.6 V. This allows for universal low-voltage bidirectional translation between any of the 1.5-V, 1.8-V, 2.5-V, and 3.3-V voltage nodes.

The SN74AVCBH164245 is designed for asynchronous communication between data buses. The device transmits data from the A bus to the B bus or from the B bus to the A bus, depending on the logic level at the direction-control (DIR) input. The output-enable ( $\overline{OE}$ ) input can be used to disable the outputs so the buses are effectively isolated.

The SN74AVCBH164245 is designed so that the control pins (1DIR, 2DIR,  $1\overline{OE}$ , and  $2\overline{OE}$ ) are supplied by  $V_{CCB}$ .

Active bus-hold circuitry is provided to hold unused or floating data inputs at a valid logic level. Use of pullup or pulldown resistors with the bus-hold circuitry is not recommended.

To ensure the high-impedance state during power up or power down,  $\overline{OE}$  should be tied to  $V_{CCB}$  through a pullup resistor; the minimum value of the resistor is determined by the current-sinking capability of the driver.

This device is fully specified for partial-power-down applications using  $I_{off}$ . The  $I_{off}$  circuitry disables the outputs, preventing damaging current backflow through the device when it is powered down. If either  $V_{CC}$  input is at GND, both ports are in the high-impedance state.

## ORDERING INFORMATION

$T_A$	PACKAGE <sup>(1)(2)</sup>		ORDERABLE PART NUMBER	TOP-SIDE MARKING
–40°C to 85°C	TSSOP – DGG	Tape and reel	SN74AVCBH164245GR	AVCBH164245
	TVSOP – DGV	Tape and reel	SN74AVCBH164245VR	WBH4245
	VFBGA – GQL	Tape and reel	SN74AVCBH164245KR	WBH4245
	VFBGA – ZQL (Pb-free)	Tape and reel	SN74AVCBH164245ZQLR	WBH4245

(1) Package drawings, thermal data, and symbolization are available at [www.ti.com/packaging](http://www.ti.com/packaging).

(2) For the most current package and ordering information, see the Package Option Addendum at the end of this document, or see the TI website at [www.ti.com](http://www.ti.com).



Please be aware that an important notice concerning availability, standard warranty, and use in critical applications of Texas Instruments semiconductor products and disclaimers thereto appears at the end of this data sheet.

Widebus, DOC are trademarks of Texas Instruments.

**SN74AVCBH164245**

**16-BIT DUAL-SUPPLY BUS TRANSCEIVER  
WITH CONFIGURABLE VOLTAGE TRANSLATION AND 3-STATE OUTPUTS**



SCES393B–JUNE 2002–REVISED MARCH 2008

**TERMINAL ASSIGNMENTS**

**DGG OR DGV PACKAGE  
(TOP VIEW)**

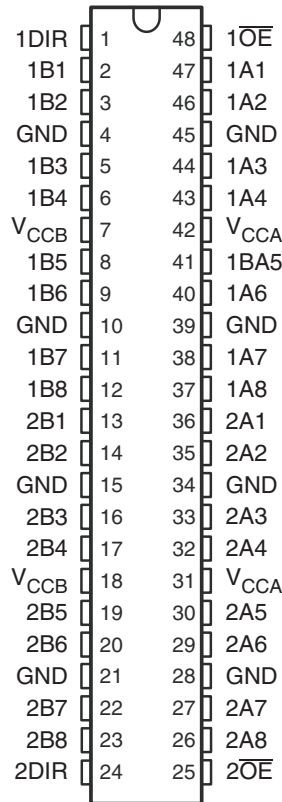

**GQL/ZQL PACKAGE  
(TOP VIEW)**

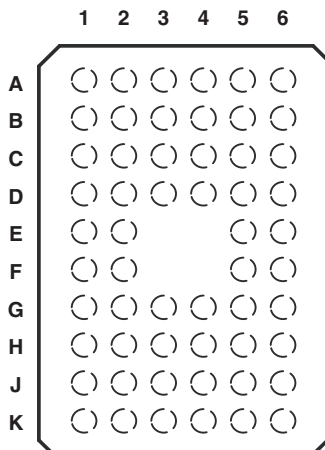

**TERMINAL ASSIGNMENTS  
(56-Ball GQL/ZQL Package)<sup>(1)</sup>**

	1	2	3	4	5	6
<b>A</b>	1DIR	NC	NC	NC	NC	1OE
<b>B</b>	1B2	1B1	GND	GND	1A1	1A2
<b>C</b>	1B4	1B3	V <sub>CCB</sub>	V <sub>CCA</sub>	1A3	1A4
<b>D</b>	1B6	1B5	GND	GND	1A5	1A6
<b>E</b>	1B8	1B7			1A7	1A8
<b>F</b>	2B1	2B2			2A2	2A1
<b>G</b>	2B3	2B4	GND	GND	2A4	2A3
<b>H</b>	2B5	2B6	V <sub>CCB</sub>	V <sub>CCA</sub>	2A6	2A5
<b>J</b>	2B7	2B8	GND	GND	2A8	2A7
<b>K</b>	2DIR	NC	NC	NC	NC	2OE

(1) NC - No internal connection

FUNCTION TABLE  
(EACH 8-BIT SECTION)

INPUTS		OPERATION
$\overline{OE}$	DIR	
L	L	B data to A bus
L	H	A data to B bus
H	X	Isolation

LOGIC DIAGRAM (POSITIVE LOGIC)

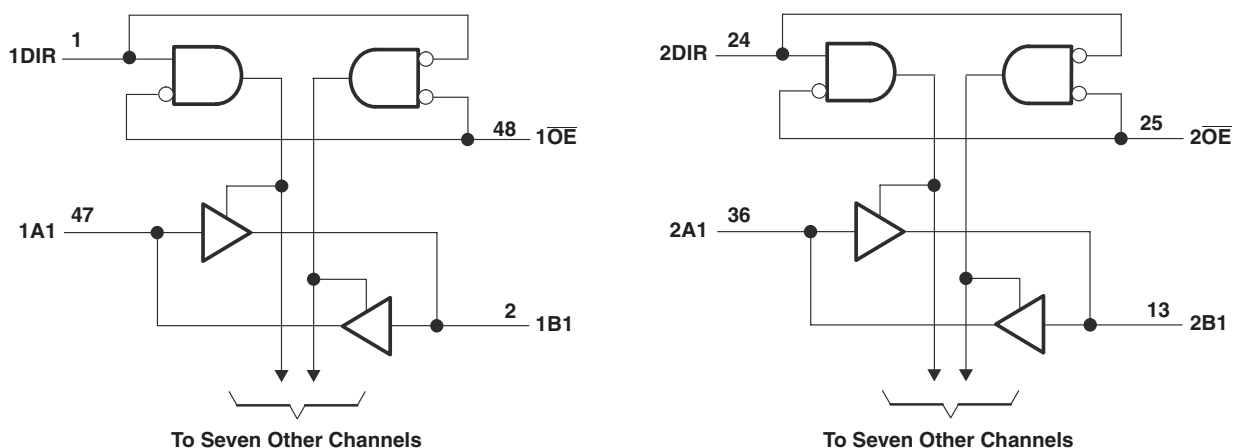

ABSOLUTE MAXIMUM RATINGS<sup>(1)</sup>

over operating free-air temperature range (unless otherwise noted)

		MIN	MAX	UNIT	
$V_{CCA}$ $V_{CCB}$	Supply voltage range	-0.5	4.6	V	
$V_I$	Input voltage range <sup>(2)</sup>	I/O ports (A port)	-0.5	4.6	V
		I/O ports (B port)	-0.5	4.6	
		Control inputs	-0.5	4.6	
$V_O$	Voltage range applied to any output in the high-impedance or power-off state <sup>(2)</sup>	A port	-0.5	4.6	V
		B port	-0.5	4.6	
$V_O$	Voltage range applied to any output in the high or low state <sup>(2)(3)</sup>	A port	-0.5	$V_{CCA} + 0.5$	V
		B port	-0.5	$V_{CCB} + 0.5$	
$I_{IK}$	Input clamp current		-50	mA	
$I_{OK}$	Output clamp current		-50	mA	
$I_O$	Continuous output current		±50	mA	
	Continuous current through $V_{CCA}$ , $V_{CCB}$ , or GND		±100	mA	
$\theta_{JA}$	Package thermal impedance <sup>(4)</sup>	DGG package	70	°C/W	
		DGV package	58		
		GQL/ZQL package	28		
$T_{stg}$	Storage temperature range	-65	150	°C	

- (1) Stresses beyond those listed under "absolute maximum ratings" may cause permanent damage to the device. These are stress ratings only, and functional operation of the device at these or any other conditions beyond those indicated under "recommended operating conditions" is not implied. Exposure to absolute-maximum-rated conditions for extended periods may affect device reliability.
- (2) The input and output negative-voltage ratings may be exceeded if the input and output current ratings are observed.
- (3) The output positive-voltage rating may be exceeded up to 4.6 V maximum if the output current rating is observed.
- (4) The package thermal impedance is calculated in accordance with JESD 51-7.

**SN74AVCBH164245**
**16-BIT DUAL-SUPPLY BUS TRANSCEIVER  
WITH CONFIGURABLE VOLTAGE TRANSLATION AND 3-STATE OUTPUTS**

SCES393B–JUNE 2002–REVISED MARCH 2008

**RECOMMENDED OPERATING CONDITIONS<sup>(1)(2)(3)</sup>**

over operating free-air temperature range (unless otherwise noted)

		$V_{CCI}$	$V_{CCO}$	MIN	MAX	UNIT
$V_{CCA}$	Supply voltage			1.4	3.6	V
$V_{CCB}$	Supply voltage			1.4	3.6	V
$V_{IH}$	High-level input voltage	Data inputs	1.4 V to 1.95 V	$V_{CCI} \times 0.65$		V
			1.95 V to 2.7 V	1.7		
			2.7 V to 3.6 V	2		
$V_{IL}$	Low-level input voltage	Data inputs	1.4 V to 1.95 V	$V_{CCI} \times 0.35$		V
			1.95 V to 2.7 V	0.7		
			2.7 V to 3.6 V	0.8		
$V_{IH}$	High-level input voltage	Control inputs (referenced to $V_{CCB}$ )	1.4 V to 1.95 V	$V_{CCB} \times 0.65$		V
			1.95 V to 2.7 V	1.7		
			2.7 V to 3.6 V	2		
$V_{IL}$	Low-level input voltage	Control inputs (referenced to $V_{CCB}$ )	1.4 V to 1.95 V	$V_{CCB} \times 0.35$		V
			1.95 V to 2.7 V	0.7		
			2.7 V to 3.6 V	0.8		
$V_I$	Input voltage			0	3.6	V
$V_O$	Output voltage	Active state		0	$V_{CCO}$	V
		3-state		0	3.6	
$I_{OH}$	High-level output current		1.4 V to 1.6 V	–2		mA
			1.65 V to 1.95 V	–4		
			2.3 V to 2.7 V	–8		
			3 V to 3.6 V	–12		
$I_{OL}$	Low-level output current		1.4 V to 1.6 V	2		mA
			1.65 V to 1.95 V	4		
			2.3 V to 2.7 V	8		
			3 V to 3.6 V	12		
$\Delta t/\Delta v$	Input transition rise or fall rate				5	ns/V
$T_A$	Operating free-air temperature			–40	85	°C

 (1)  $V_{CCI}$  is the  $V_{CC}$  associated with the data input port.

 (2)  $V_{CCO}$  is the  $V_{CC}$  associated with the data output port.

 (3) All unused data inputs of the device must be held at  $V_{CCI}$  or GND to ensure proper device operation. Refer to the TI application report, *Implications of Slow or Floating CMOS Inputs*, literature number SCBA004.

## ELECTRICAL CHARACTERISTICS<sup>(1)(2)</sup>

over operating free-air temperature range (unless otherwise noted)

PARAMETER		TEST CONDITIONS		V <sub>CCA</sub>	V <sub>CCB</sub>	MIN	TYP <sup>(3)</sup>	MAX	UNIT
V <sub>OH</sub>		I <sub>OH</sub> = -100 μA	V <sub>I</sub> = V <sub>IH</sub>	1.4 V to 3.6 V	1.4 V to 3.6 V	V <sub>CCO</sub> - 0.2			V
		I <sub>OH</sub> = -2 mA	V <sub>I</sub> = V <sub>IH</sub>	1.4 V	1.4 V	1.05			
		I <sub>OH</sub> = -4 mA	V <sub>I</sub> = V <sub>IH</sub>	1.65 V	1.65 V	1.2			
		I <sub>OH</sub> = -8 mA	V <sub>I</sub> = V <sub>IH</sub>	2.3 V	2.3 V	1.75			
		I <sub>OH</sub> = -12 mA	V <sub>I</sub> = V <sub>IH</sub>	3 V	3 V	2.3			
V <sub>OL</sub>		I <sub>OH</sub> = 100 μA	V <sub>I</sub> = V <sub>IL</sub>	1.4 V to 3.6 V	1.4 V to 3.6 V			0.2	V
		I <sub>OH</sub> = 2 mA	V <sub>I</sub> = V <sub>IL</sub>	1.4 V	1.4 V			0.35	
		I <sub>OH</sub> = 4 mA	V <sub>I</sub> = V <sub>IL</sub>	1.65 V	1.65 V			0.45	
		I <sub>OH</sub> = 8 mA	V <sub>I</sub> = V <sub>IL</sub>	2.3 V	2.3 V			0.55	
		I <sub>OH</sub> = 12 mA	V <sub>I</sub> = V <sub>IL</sub>	3 V	3 V			0.7	
I <sub>I</sub>	Control inputs	V <sub>I</sub> = V <sub>CCB</sub> or GND		1.4 V to 3.6 V	3.6 V			±2.5	μA
I <sub>BHL</sub> <sup>(4)</sup>		V <sub>I</sub> = 0.49 V		1.4 V	1.4 V		11		μA
		V <sub>I</sub> = 0.57 V		1.65 V	1.65 V		25		
		V <sub>I</sub> = 0.7 V		2.3 V	2.3 V		45		
		V <sub>I</sub> = 0.8 V		3 V	3 V		75		
I <sub>BHH</sub> <sup>(5)</sup>		V <sub>I</sub> = 0.49 V		1.4 V	1.4 V		-11		μA
		V <sub>I</sub> = 0.57 V		1.65 V	1.65 V		-25		
		V <sub>I</sub> = 0.7 V		2.3 V	2.3 V		-45		
		V <sub>I</sub> = 0.8 V		3 V	3 V		-75		
I <sub>BHLO</sub> <sup>(6)</sup>		V <sub>I</sub> = 0 to V <sub>CC</sub>		1.6 V	1.6 V		100		μA
				1.95 V	1.95 V		200		
				2.7 V	2.7 V		300		
				3.6 V	3.6 V		525		
I <sub>BHHO</sub> <sup>(7)</sup>		V <sub>I</sub> = 0 to V <sub>CC</sub>		1.6 V	1.6 V		-100		μA
				1.95 V	1.95 V		-200		
				2.7 V	2.7 V		-300		
				3.6 V	3.6 V		-525		
I <sub>off</sub>	A port	V <sub>I</sub> or V <sub>O</sub> = 0 to 3.6 V		0 V	0 to 3.6 V			±10	μA
	B port			0 to 3.6 V	0 V			±10	
I <sub>OZ</sub> <sup>(8)</sup>	A or B ports	V <sub>O</sub> = V <sub>CCO</sub> or GND, V <sub>I</sub> = V <sub>CCi</sub> or GND	OE = V <sub>IH</sub>	3.6 V	3.6 V			±12.5	μA
	B port		OE = don't care	0 V	3.6 V			±12.5	
	A port			3.6 V	0 V			±12.5	
I <sub>CCA</sub>		V <sub>I</sub> = V <sub>CCi</sub> or GND, I <sub>O</sub> = 0		1.6 V	1.6 V			20	μA
				1.95 V	1.95 V			20	
				2.7 V	2.7 V			30	
				0 V	3.6 V			-40	
				3.6 V	0 V			40	
				3.6 V	3.6 V			40	

- (1) V<sub>CCO</sub> is the V<sub>CC</sub> associated with the output port.
- (2) V<sub>CCi</sub> is the V<sub>CC</sub> associated with the input port.
- (3) All typical values are at T<sub>A</sub> = 25°C.
- (4) The bus-hold circuit can sink at least the minimum low sustaining current at V<sub>IL</sub> max. IBHL should be measured after lowering VIN to GND and then raising it to V<sub>IL</sub> max.
- (5) The bus-hold circuit can source at least the minimum high sustaining current at V<sub>IH</sub> min. IBHH should be measured after raising VIN to V<sub>CC</sub> and then lowering it to V<sub>IH</sub> min.
- (6) An external driver must source at least IBHLO to switch this node from low to high.
- (7) An external driver must sink at least IBHHO to switch this node from high to low.
- (8) For I/O ports, the parameter I<sub>OZ</sub> includes the input leakage current.

**SN74AVCBH164245**

**16-BIT DUAL-SUPPLY BUS TRANSCEIVER  
WITH CONFIGURABLE VOLTAGE TRANSLATION AND 3-STATE OUTPUTS**



SCES393B–JUNE 2002–REVISED MARCH 2008

**ELECTRICAL CHARACTERISTICS (continued)**

over operating free-air temperature range (unless otherwise noted)

PARAMETER		TEST CONDITIONS	V <sub>CCA</sub>	V <sub>CCB</sub>	MIN	TYP <sup>(3)</sup>	MAX	UNIT
I <sub>CCB</sub>		V <sub>I</sub> = V <sub>CC1</sub> or GND, I <sub>O</sub> = 0	1.6 V	1.6 V			20	μA
			1.95 V	1.95 V			20	
			2.7 V	2.7 V			30	
			0 V	3.6 V			40	
			3.6 V	0 V			–40	
			3.6 V	3.6 V			40	
C <sub>i</sub>	Control inputs	V <sub>I</sub> = 3.3 V or GND	3.3 V	3.3 V		4	pF	
C <sub>io</sub>	A or B ports	V <sub>O</sub> = 3.3 V or GND	3.3 V	3.3 V		5	pF	

**SWITCHING CHARACTERISTICS**

over recommended operating free-air temperature range, V<sub>CCA</sub> = 1.5 V ± 0.1 V (see Figure 2)

PARAMETER	FROM (INPUT)	TO (OUTPUT)	V <sub>CCB</sub> = 1.5 V ± 0.1 V		V <sub>CCB</sub> = 1.8 V ± 0.15 V		V <sub>CCB</sub> = 2.5 V ± 0.2 V		V <sub>CCB</sub> = 3.3 V ± 0.3 V		UNIT
			MIN	MAX	MIN	MAX	MIN	MAX	MIN	MAX	
t <sub>pd</sub>	A	B	1.7	6.7	1.9	6.3	1.8	5.5	1.7	5.8	ns
	B	A	1.8	6.8	2.2	7.4	2.1	7.6	2.1	7.3	
t <sub>en</sub>	OE	A	2.5	8.4	2.4	7.4	2.1	5.2	1.9	4.2	ns
		B	2.1	9	2.9	9.8	3.2	10	3	9.8	
t <sub>dis</sub>	OE	A	2.2	6.9	2.3	6.1	1.3	3.6	1.3	3	ns
		B	2.1	7.1	2.3	6.4	1.7	5.15.1	1.6	4.8	

**SWITCHING CHARACTERISTICS**

over recommended operating free-air temperature range, V<sub>CCA</sub> = 1.8 V ± 0.15 V (see Figure 2)

PARAMETER	FROM (INPUT)	TO (OUTPUT)	V <sub>CCB</sub> = 1.5 V ± 0.1 V		V <sub>CCB</sub> = 1.8 V ± 0.15 V		V <sub>CCB</sub> = 2.5 V ± 0.2 V		V <sub>CCB</sub> = 3.3 V ± 0.3 V		UNIT
			MIN	MAX	MIN	MAX	MIN	MAX	MIN	MAX	
t <sub>pd</sub>	A	B	1.7	6.7	1.8	6	1.7	4.7	1.6	4.3	ns
	B	A	1.4	5.5	1.8	6	1.8	5.8	1.8	5.5	
t <sub>en</sub>	OE	A	2.6	8.5	2.5	7.5	2.2	5.3	1.9	4.2	ns
		B	1.8	7.6	2.6	7.7	2.6	7.6	2.6	7.4	
t <sub>dis</sub>	OE	A	2.3	7	2.3	6.1	1.3	3.6	1.3	3	ns
		B	1.8	7	2.5	6.3	1.8	4.7	1.7	4.4	

**SWITCHING CHARACTERISTICS**

over recommended operating free-air temperature range, V<sub>CCA</sub> = 2.5 V ± 0.2 V (see Figure 2)

PARAMETER	FROM (INPUT)	TO (OUTPUT)	V <sub>CCB</sub> = 1.5 V ± 0.1 V		V <sub>CCB</sub> = 1.8 V ± 0.15 V		V <sub>CCB</sub> = 2.5 V ± 0.2 V		V <sub>CCB</sub> = 3.3 V ± 0.3 V		UNIT
			MIN	MAX	MIN	MAX	MIN	MAX	MIN	MAX	
t <sub>pd</sub>	A	B	1.6	6	1.8	5.6	1.5	4	1.4	3.4	ns
	B	A	1.3	4.6	1.7	4.4	1.5	4	1.4	3.7	
t <sub>en</sub>	OE	A	3.1	8.5	2.5	7.5	2.2	5.3	1.9	4.2	ns
		B	1.7	5.7	2.2	5.5	2.2	5.3	2.2	5.1	
t <sub>dis</sub>	OE	A	2.4	7	3	6.1	1.4	3.6	1.2	3	ns
		B	1.2	5.8	1.9	5	1.4	3.6	1.3	3.3	

**SWITCHING CHARACTERISTICS**

over recommended operating free-air temperature range,  $V_{CCA} = 3.3\text{ V} \pm 0.3\text{ V}$  (see Figure 2)

PARAMETER	FROM (INPUT)	TO (OUTPUT)	$V_{CCB} = 1.5\text{ V} \pm 0.1\text{ V}$		$V_{CCB} = 1.8\text{ V} \pm 0.15\text{ V}$		$V_{CCB} = 2.5\text{ V} \pm 0.2\text{ V}$		$V_{CCB} = 3.3\text{ V} \pm 0.3\text{ V}$		UNIT
			MIN	MAX	MIN	MAX	MIN	MAX	MIN	MAX	
$t_{pd}$	A	B	1.5	5.9	1.7	5.4	1.5	3.7	1.4	3.1	ns
	B	A	1.3	4.5	1.6	3.8	1.5	3.3	1.4	3.1	
$t_{en}$	$\overline{OE}$	A	2.6	8.3	2.5	7.4	2.2	5.2	1.9	4.1	ns
		B	1.6	4.9	2	4.5	2	4.3	1.9	4.1	
$t_{dis}$	$\overline{OE}$	A	2.3	7	3	6	1.3	3.5	1.2	3.5	ns
		B	1.3	6.9	2.1	5.5	1.6	3.8	1.5	3.5	

**OPERATING CHARACTERISTICS**

$V_{CCA}$  and  $V_{CCB} = 3.3\text{ V}$ ,  $T_A = 25^\circ\text{C}$

PARAMETER		TEST CONDITIONS	TYP	UNIT
$C_{pdA}$ ( $V_{CCA}$ )	Power dissipation capacitance per transceiver, A-port input, B-port output	Outputs enabled	14	pF
		Outputs disabled	7	
	Power dissipation capacitance per transceiver, B-port input, A-port output	Outputs enabled	20	
		Outputs disabled	7	
$C_{pdB}$ ( $V_{CCB}$ )	Power dissipation capacitance per transceiver, A-port input, B-port output	Outputs enabled	20	pF
		Outputs disabled	7	
	Power dissipation capacitance per transceiver, B-port input, A-port output	Outputs enabled	14	
		Outputs disabled	7	

**Output Description**

The DOC™ circuitry is implemented, which, during the transition, initially lowers the output impedance to effectively drive the load and, subsequently, raises the impedance to reduce noise. Figure 1 shows typical  $V_{OL}$  vs  $I_{OL}$  and  $V_{OH}$  vs  $I_{OH}$  curves to illustrate the output impedance and drive capability of the circuit. At the beginning of the signal transition, the DOC circuit provides a maximum dynamic drive that is equivalent to a high-drive standard-output device. For more information, refer to the TI application reports, *AVC Logic Family Technology and Applications*, literature number SCEA006, and *Dynamic Output Control (DOC™) Circuitry Technology and Applications*, literature number SCEA009.

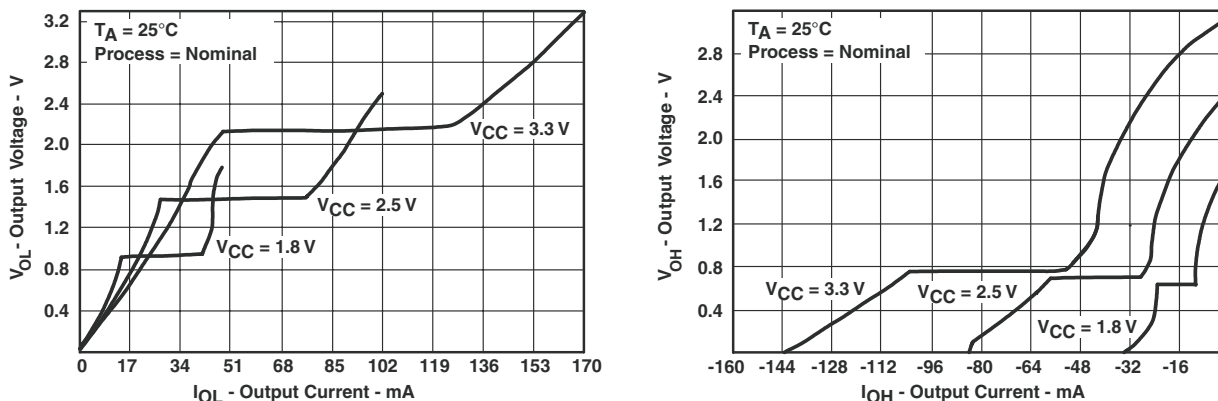

**Figure 1. Typical Output Voltage vs Output Current**



**SN74AVCBH164245**

**16-BIT DUAL-SUPPLY BUS TRANSCEIVER  
WITH CONFIGURABLE VOLTAGE TRANSLATION AND 3-STATE OUTPUTS**



SCES393B–JUNE 2002–REVISED MARCH 2008

**PARAMETER MEASUREMENT INFORMATION**

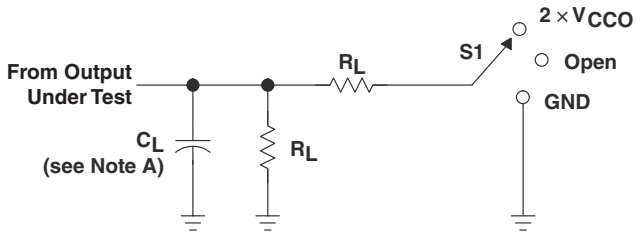

LOAD CIRCUIT

TEST	S1
$t_{pd}$	Open
$t_{PLZ}/t_{PZL}$	$2 \times V_{CCO}$
$t_{PHZ}/t_{PZH}$	GND

$V_{CCO}$	$C_L$	$R_L$	$V_{TP}$
$1.5\text{ V} \pm 0.1\text{ V}$	15 pF	2 k $\Omega$	0.1 V
$1.8\text{ V} \pm 0.15\text{ V}$	30 pF	1 k $\Omega$	0.15 V
$2.5\text{ V} \pm 0.2\text{ V}$	30 pF	500 $\Omega$	0.15 V
$3.3\text{ V} \pm 0.3\text{ V}$	30 pF	500 $\Omega$	0.3 V

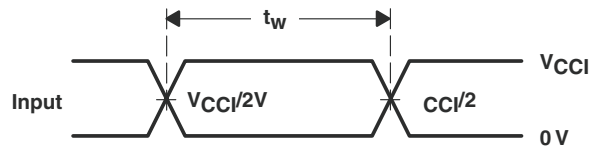

VOLTAGE WAVEFORMS  
PULSE DURATION

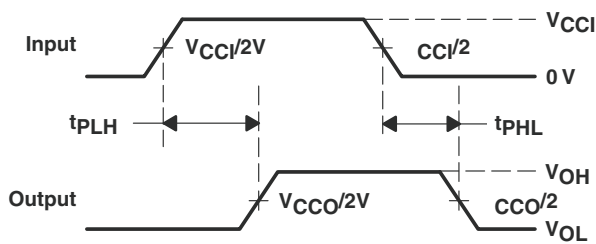



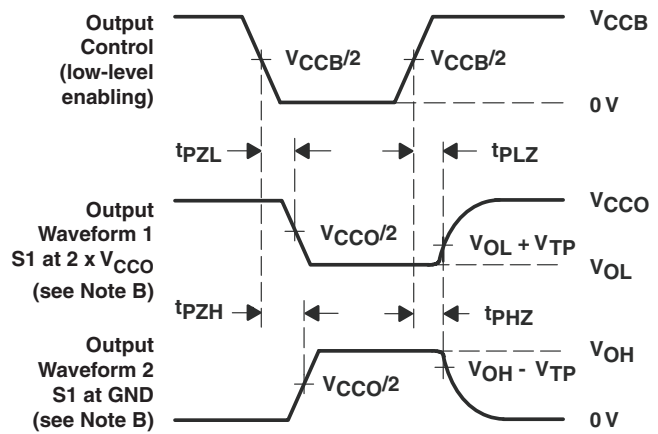

VOLTAGE WAVEFORMS  
PROPAGATION DELAY TIMES



VOLTAGE WAVEFORMS  
ENABLE AND DISABLE TIMES

**Figure 2. Load Circuit and Voltage Waveforms**

**PACKAGING INFORMATION**

Orderable Device	Status (1)	Package Type	Package Drawing	Pins	Package Qty	Eco Plan (2)	Lead/Ball Finish (6)	MSL Peak Temp (3)	Op Temp (°C)	Device Marking (4/5)	Samples
74AVCBH164245GRE4	ACTIVE	TSSOP	DGG	48	2000	Green (RoHS & no Sb/Br)	CU NIPDAU	Level-1-260C-UNLIM	-40 to 85	AVCBH164245	
74AVCBH164245GRG4	ACTIVE	TSSOP	DGG	48	2000	Green (RoHS & no Sb/Br)	CU NIPDAU	Level-1-260C-UNLIM	-40 to 85	AVCBH164245	
74AVCBH164245ZQLR	ACTIVE	BGA MICROSTAR JUNIOR	ZQL	56	1000	Green (RoHS & no Sb/Br)	SNAGCU	Level-1-260C-UNLIM	-40 to 85	WBH4245	
SN74AVCBH164245GR	ACTIVE	TSSOP	DGG	48	2000	Green (RoHS & no Sb/Br)	CU NIPDAU	Level-1-260C-UNLIM	-40 to 85	AVCBH164245	
SN74AVCBH164245KR	OBSOLETE	BGA MICROSTAR JUNIOR	GQL	56		TBD	Call TI	Call TI	-40 to 85	WBH4245	
SN74AVCBH164245VR	ACTIVE	TVSOP	DGV	48	2000	Green (RoHS & no Sb/Br)	CU NIPDAU	Level-1-260C-UNLIM	-40 to 85	WBH4245	

<sup>(1)</sup> The marketing status values are defined as follows:

**ACTIVE:** Product device recommended for new designs.

**LIFEBUY:** TI has announced that the device will be discontinued, and a lifetime-buy period is in effect.

**NRND:** Not recommended for new designs. Device is in production to support existing customers, but TI does not recommend using this part in a new design.

**PREVIEW:** Device has been announced but is not in production. Samples may or may not be available.

**OBSOLETE:** TI has discontinued the production of the device.

<sup>(2)</sup> Eco Plan - The planned eco-friendly classification: Pb-Free (RoHS), Pb-Free (RoHS Exempt), or Green (RoHS & no Sb/Br) - please check <http://www.ti.com/productcontent> for the latest availability information and additional product content details.

**TBD:** The Pb-Free/Green conversion plan has not been defined.

**Pb-Free (RoHS):** TI's terms "Lead-Free" or "Pb-Free" mean semiconductor products that are compatible with the current RoHS requirements for all 6 substances, including the requirement that lead not exceed 0.1% by weight in homogeneous materials. Where designed to be soldered at high temperatures, TI Pb-Free products are suitable for use in specified lead-free processes.

**Pb-Free (RoHS Exempt):** This component has a RoHS exemption for either 1) lead-based flip-chip solder bumps used between the die and package, or 2) lead-based die adhesive used between the die and leadframe. The component is otherwise considered Pb-Free (RoHS compatible) as defined above.

**Green (RoHS & no Sb/Br):** TI defines "Green" to mean Pb-Free (RoHS compatible), and free of Bromine (Br) and Antimony (Sb) based flame retardants (Br or Sb do not exceed 0.1% by weight in homogeneous material)

<sup>(3)</sup> MSL, Peak Temp. - The Moisture Sensitivity Level rating according to the JEDEC industry standard classifications, and peak solder temperature.

<sup>(4)</sup> There may be additional marking, which relates to the logo, the lot trace code information, or the environmental category on the device.



---

<sup>(5)</sup> Multiple Device Markings will be inside parentheses. Only one Device Marking contained in parentheses and separated by a "-" will appear on a device. If a line is indented then it is a continuation of the previous line and the two combined represent the entire Device Marking for that device.

<sup>(6)</sup> Lead/Ball Finish - Orderable Devices may have multiple material finish options. Finish options are separated by a vertical ruled line. Lead/Ball Finish values may wrap to two lines if the finish value exceeds the maximum column width.

**Important Information and Disclaimer:** The information provided on this page represents TI's knowledge and belief as of the date that it is provided. TI bases its knowledge and belief on information provided by third parties, and makes no representation or warranty as to the accuracy of such information. Efforts are underway to better integrate information from third parties. TI has taken and continues to take reasonable steps to provide representative and accurate information but may not have conducted destructive testing or chemical analysis on incoming materials and chemicals. TI and TI suppliers consider certain information to be proprietary, and thus CAS numbers and other limited information may not be available for release.

In no event shall TI's liability arising out of such information exceed the total purchase price of the TI part(s) at issue in this document sold by TI to Customer on an annual basis.

**TAPE AND REEL INFORMATION**

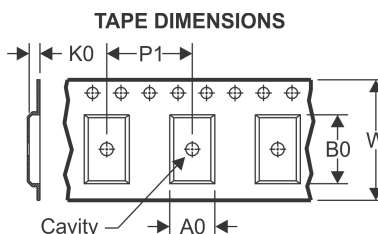
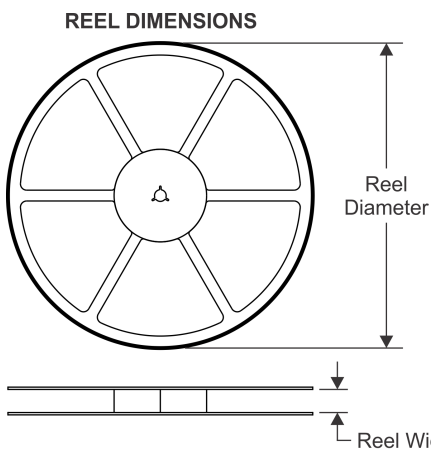

A0	Dimension designed to accommodate the component width
B0	Dimension designed to accommodate the component length
K0	Dimension designed to accommodate the component thickness
W	Overall width of the carrier tape
P1	Pitch between successive cavity centers

**QUADRANT ASSIGNMENTS FOR PIN 1 ORIENTATION IN TAPE**

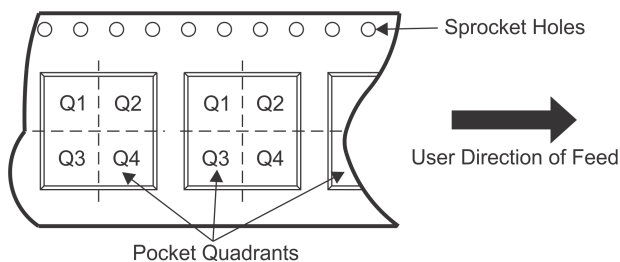

\*All dimensions are nominal

Device	Package Type	Package Drawing	Pins	SPQ	Reel Diameter (mm)	Reel Width W1 (mm)	A0 (mm)	B0 (mm)	K0 (mm)	P1 (mm)	W (mm)	Pin1 Quadrant
74AVCBH164245ZQLR	BGA MICROSTAR JUNIOR	ZQL	56	1000	330.0	16.4	4.8	7.3	1.5	8.0	16.0	Q1
SN74AVCBH164245GR	TSSOP	DGG	48	2000	330.0	24.4	8.6	15.8	1.8	12.0	24.0	Q1
SN74AVCBH164245VR	TVSOP	DGV	48	2000	330.0	16.4	7.1	10.2	1.6	12.0	16.0	Q1

**TAPE AND REEL BOX DIMENSIONS**

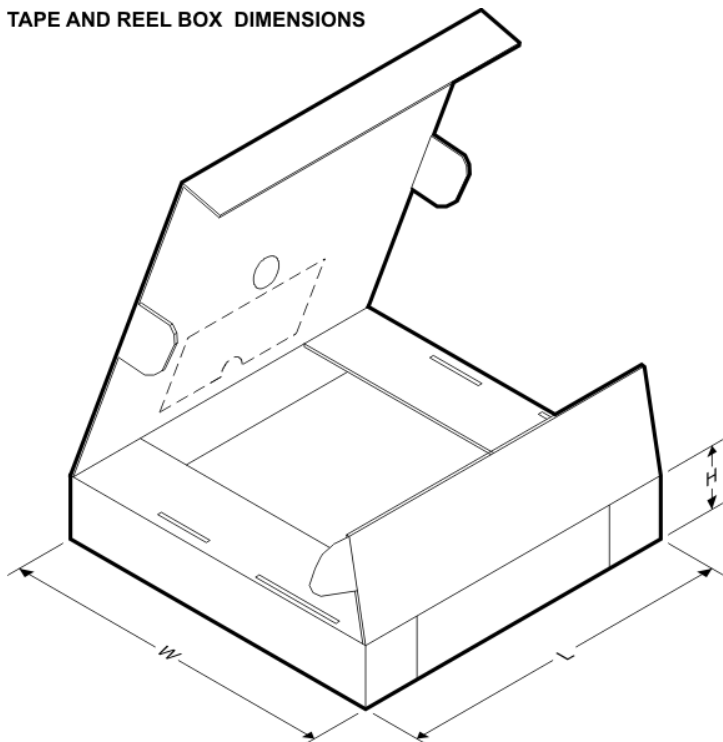

\*All dimensions are nominal

Device	Package Type	Package Drawing	Pins	SPQ	Length (mm)	Width (mm)	Height (mm)
74AVCBH164245ZQLR	BGA MICROSTAR JUNIOR	ZQL	56	1000	336.6	336.6	28.6
SN74AVCBH164245GR	TSSOP	DGG	48	2000	367.0	367.0	45.0
SN74AVCBH164245VR	TVSOP	DGV	48	2000	367.0	367.0	38.0

**MECHANICAL DATA**

ZQL (R-PBGA-N56)

PLASTIC BALL GRID ARRAY

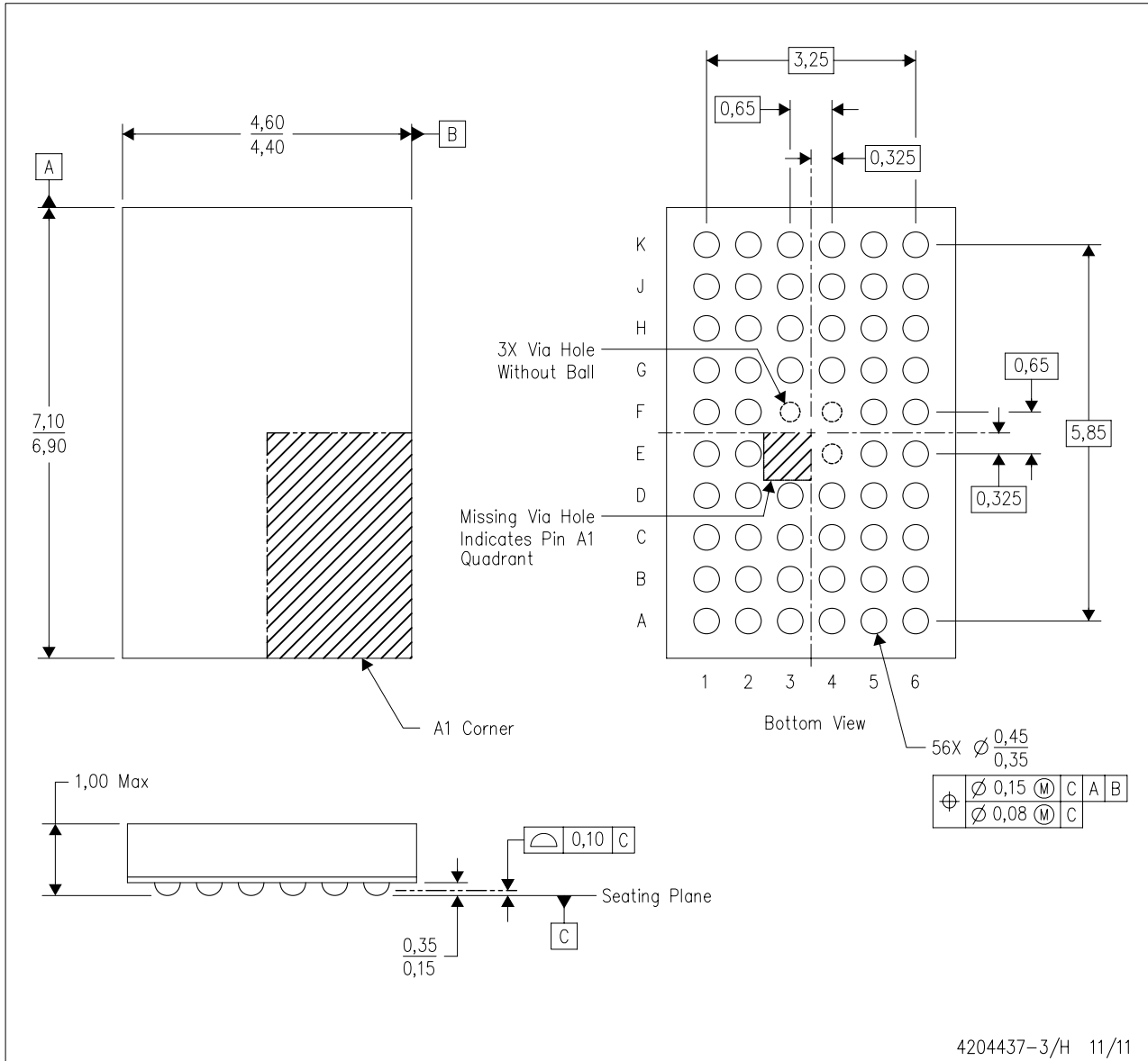

- NOTES:
- A. All linear dimensions are in millimeters. Dimensioning and tolerancing per ASME Y14.5M-1994.
  - B. This drawing is subject to change without notice.
  - C. Falls within JEDEC MO-285 variation BA-2.
  - D. This package is Pb-free. Refer to the 56 GQL package (drawing 4200583) for tin-lead (SnPb).

MPDS006C – FEBRUARY 1996 – REVISED AUGUST 2000

**DGV (R-PDSO-G\*\*)**

**PLASTIC SMALL-OUTLINE**

24 PINS SHOWN

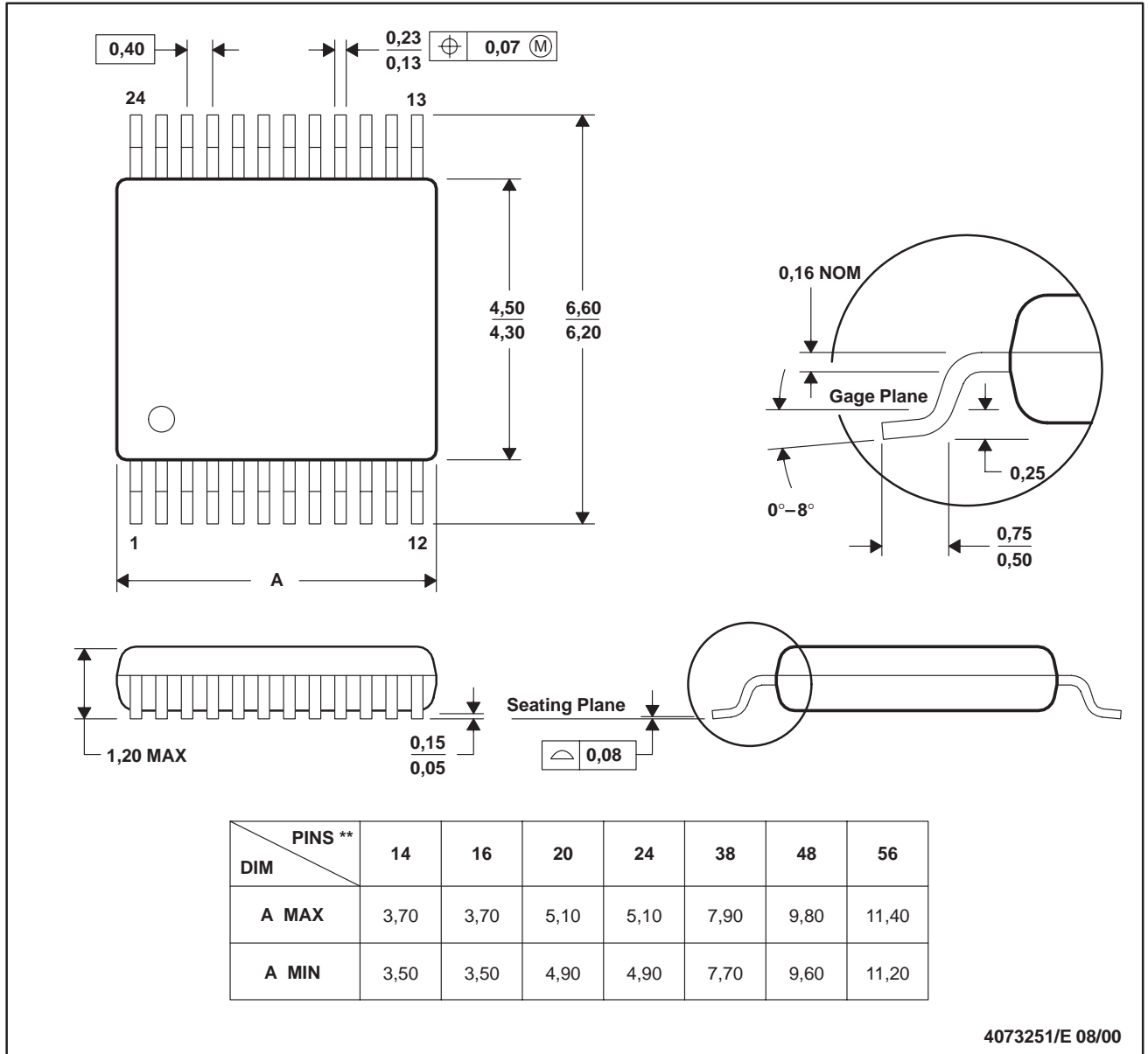

4073251/E 08/00

- NOTES: A. All linear dimensions are in millimeters.  
 B. This drawing is subject to change without notice.  
 C. Body dimensions do not include mold flash or protrusion, not to exceed 0,15 per side.  
 D. Falls within JEDEC: 24/48 Pins – MO-153  
 14/16/20/56 Pins – MO-194

**MECHANICAL DATA**

**GQL (R-PBGA-N56)**

**PLASTIC BALL GRID ARRAY**

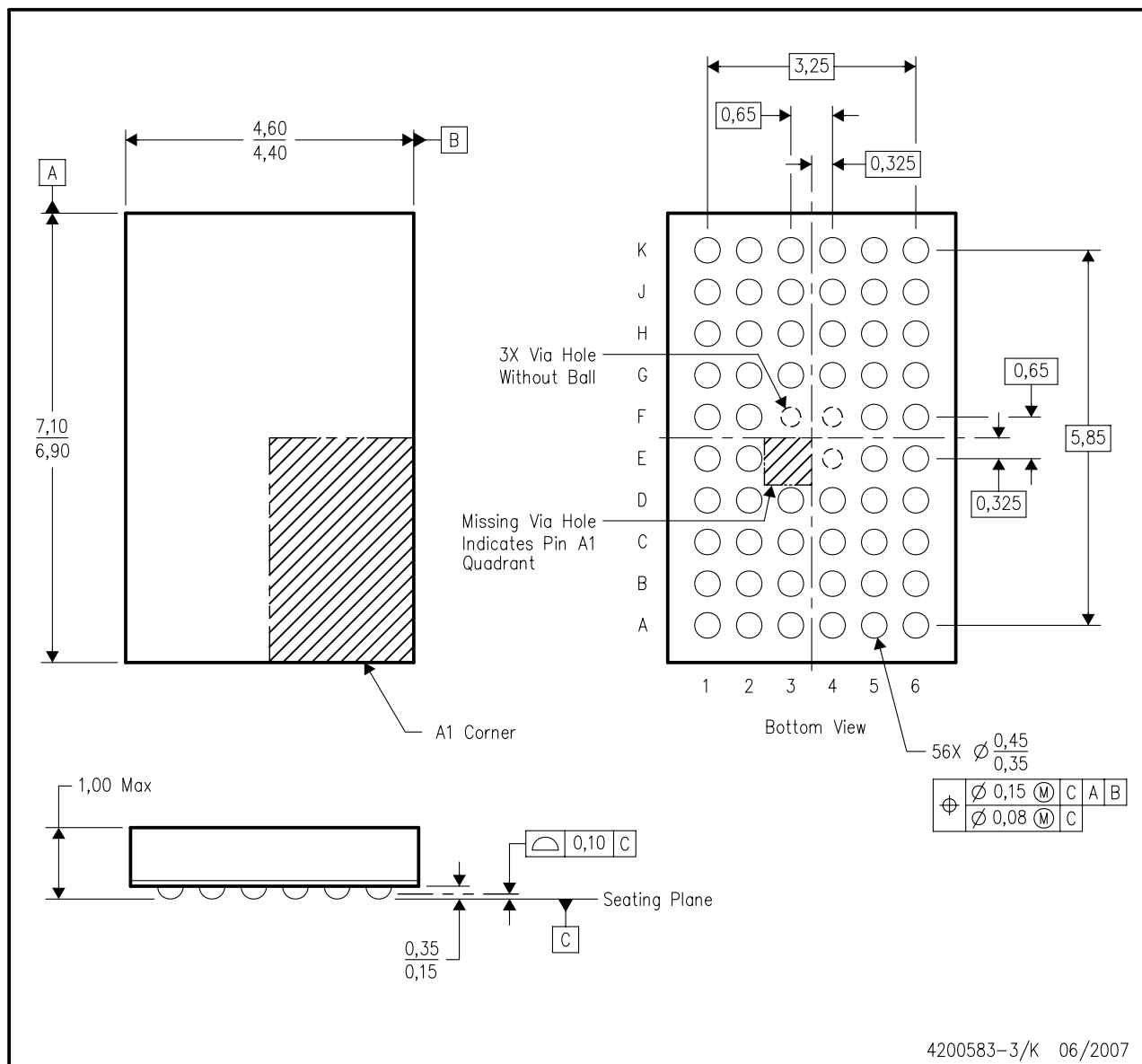

- NOTES:
- A. All linear dimensions are in millimeters. Dimensioning and tolerancing per ASME Y14.5M-1994.
  - B. This drawing is subject to change without notice.
  - C. Falls within JEDEC MO-285 variation BA-2.
  - D. This package is tin-lead (SnPb). Refer to the 56 ZQL package (drawing 4204437) for lead-free.



MTSS003D – JANUARY 1995 – REVISED JANUARY 1998

**DGG (R-PDSO-G\*\*)**

**PLASTIC SMALL-OUTLINE PACKAGE**

48 PINS SHOWN

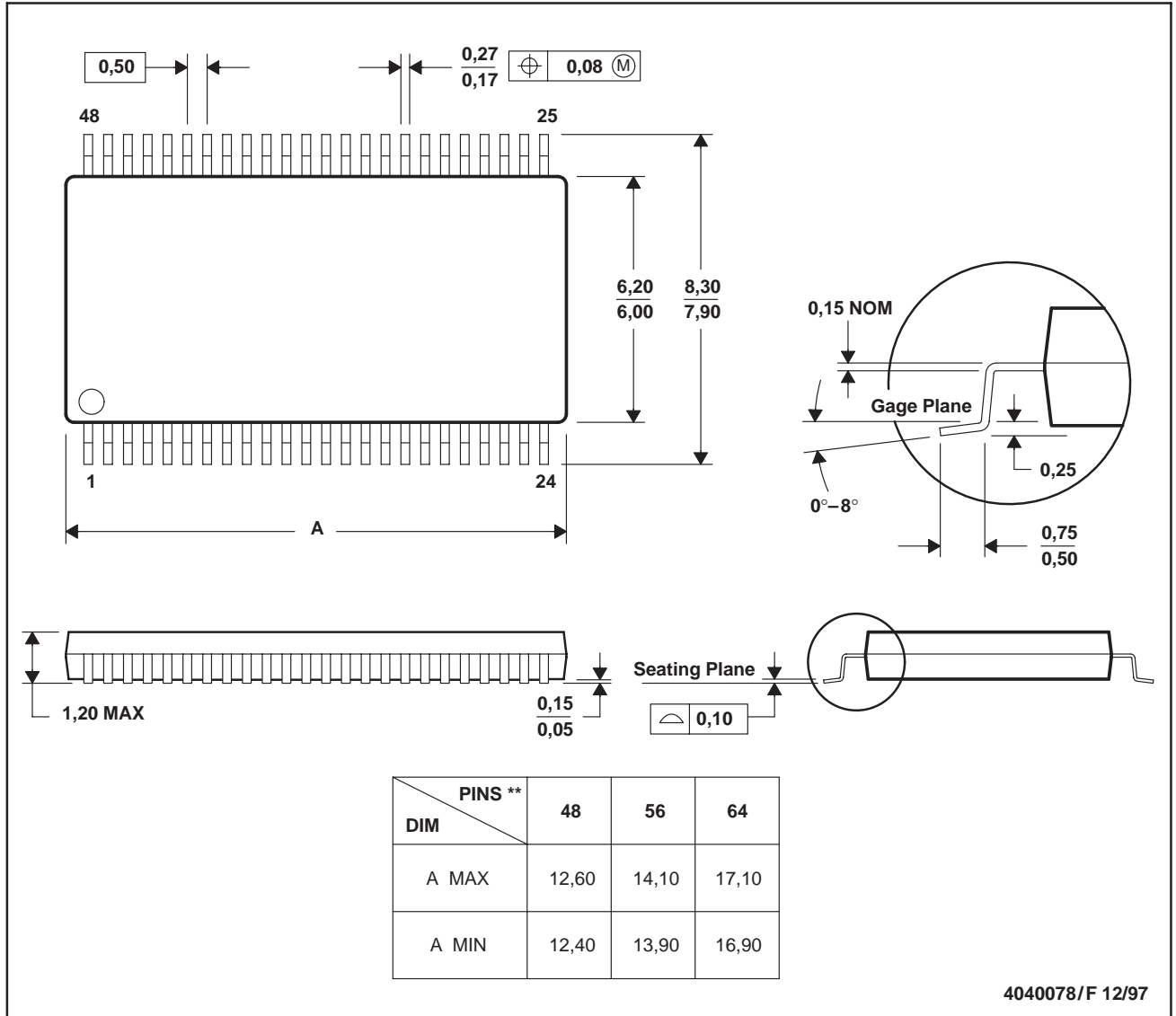

- NOTES: A. All linear dimensions are in millimeters.  
 B. This drawing is subject to change without notice.  
 C. Body dimensions do not include mold protrusion not to exceed 0,15.  
 D. Falls within JEDEC MO-153

## IMPORTANT NOTICE

Texas Instruments Incorporated and its subsidiaries (TI) reserve the right to make corrections, enhancements, improvements and other changes to its semiconductor products and services per JESD46, latest issue, and to discontinue any product or service per JESD48, latest issue. Buyers should obtain the latest relevant information before placing orders and should verify that such information is current and complete. All semiconductor products (also referred to herein as “components”) are sold subject to TI’s terms and conditions of sale supplied at the time of order acknowledgment.

TI warrants performance of its components to the specifications applicable at the time of sale, in accordance with the warranty in TI’s terms and conditions of sale of semiconductor products. Testing and other quality control techniques are used to the extent TI deems necessary to support this warranty. Except where mandated by applicable law, testing of all parameters of each component is not necessarily performed.

TI assumes no liability for applications assistance or the design of Buyers’ products. Buyers are responsible for their products and applications using TI components. To minimize the risks associated with Buyers’ products and applications, Buyers should provide adequate design and operating safeguards.

TI does not warrant or represent that any license, either express or implied, is granted under any patent right, copyright, mask work right, or other intellectual property right relating to any combination, machine, or process in which TI components or services are used. Information published by TI regarding third-party products or services does not constitute a license to use such products or services or a warranty or endorsement thereof. Use of such information may require a license from a third party under the patents or other intellectual property of the third party, or a license from TI under the patents or other intellectual property of TI.

Reproduction of significant portions of TI information in TI data books or data sheets is permissible only if reproduction is without alteration and is accompanied by all associated warranties, conditions, limitations, and notices. TI is not responsible or liable for such altered documentation. Information of third parties may be subject to additional restrictions.

Resale of TI components or services with statements different from or beyond the parameters stated by TI for that component or service voids all express and any implied warranties for the associated TI component or service and is an unfair and deceptive business practice. TI is not responsible or liable for any such statements.

Buyer acknowledges and agrees that it is solely responsible for compliance with all legal, regulatory and safety-related requirements concerning its products, and any use of TI components in its applications, notwithstanding any applications-related information or support that may be provided by TI. Buyer represents and agrees that it has all the necessary expertise to create and implement safeguards which anticipate dangerous consequences of failures, monitor failures and their consequences, lessen the likelihood of failures that might cause harm and take appropriate remedial actions. Buyer will fully indemnify TI and its representatives against any damages arising out of the use of any TI components in safety-critical applications.

In some cases, TI components may be promoted specifically to facilitate safety-related applications. With such components, TI’s goal is to help enable customers to design and create their own end-product solutions that meet applicable functional safety standards and requirements. Nonetheless, such components are subject to these terms.

No TI components are authorized for use in FDA Class III (or similar life-critical medical equipment) unless authorized officers of the parties have executed a special agreement specifically governing such use.

Only those TI components which TI has specifically designated as military grade or “enhanced plastic” are designed and intended for use in military/aerospace applications or environments. Buyer acknowledges and agrees that any military or aerospace use of TI components which have **not** been so designated is solely at the Buyer’s risk, and that Buyer is solely responsible for compliance with all legal and regulatory requirements in connection with such use.

TI has specifically designated certain components as meeting ISO/TS16949 requirements, mainly for automotive use. In any case of use of non-designated products, TI will not be responsible for any failure to meet ISO/TS16949.

### Products

Audio	<a href="http://www.ti.com/audio">www.ti.com/audio</a>
Amplifiers	<a href="http://amplifier.ti.com">amplifier.ti.com</a>
Data Converters	<a href="http://dataconverter.ti.com">dataconverter.ti.com</a>
DLP® Products	<a href="http://www.dlp.com">www.dlp.com</a>
DSP	<a href="http://dsp.ti.com">dsp.ti.com</a>
Clocks and Timers	<a href="http://www.ti.com/clocks">www.ti.com/clocks</a>
Interface	<a href="http://interface.ti.com">interface.ti.com</a>
Logic	<a href="http://logic.ti.com">logic.ti.com</a>
Power Mgmt	<a href="http://power.ti.com">power.ti.com</a>
Microcontrollers	<a href="http://microcontroller.ti.com">microcontroller.ti.com</a>
RFID	<a href="http://www.ti-rfid.com">www.ti-rfid.com</a>
OMAP Applications Processors	<a href="http://www.ti.com/omap">www.ti.com/omap</a>
Wireless Connectivity	<a href="http://www.ti.com/wirelessconnectivity">www.ti.com/wirelessconnectivity</a>

### Applications

Automotive and Transportation	<a href="http://www.ti.com/automotive">www.ti.com/automotive</a>
Communications and Telecom	<a href="http://www.ti.com/communications">www.ti.com/communications</a>
Computers and Peripherals	<a href="http://www.ti.com/computers">www.ti.com/computers</a>
Consumer Electronics	<a href="http://www.ti.com/consumer-apps">www.ti.com/consumer-apps</a>
Energy and Lighting	<a href="http://www.ti.com/energy">www.ti.com/energy</a>
Industrial	<a href="http://www.ti.com/industrial">www.ti.com/industrial</a>
Medical	<a href="http://www.ti.com/medical">www.ti.com/medical</a>
Security	<a href="http://www.ti.com/security">www.ti.com/security</a>
Space, Avionics and Defense	<a href="http://www.ti.com/space-avionics-defense">www.ti.com/space-avionics-defense</a>
Video and Imaging	<a href="http://www.ti.com/video">www.ti.com/video</a>

### TI E2E Community

[e2e.ti.com](http://e2e.ti.com)