

Excellent Integrated System Limited

Stocking Distributor

Click to view price, real time Inventory, Delivery & Lifecycle Information:

[FCI](#)

[10106118-4009002LF](#)

For any questions, you can email us directly:

sales@integrated-circuit.com

PRODUCT NUMBER SEE SHEET 2

A

B

C

D

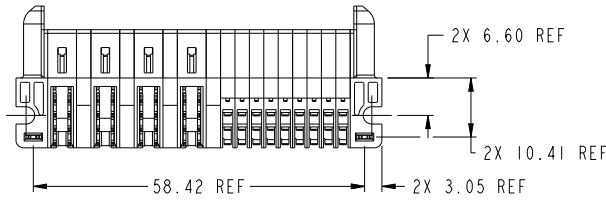
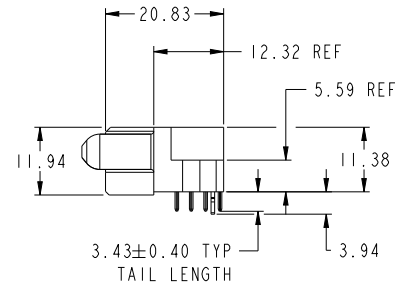
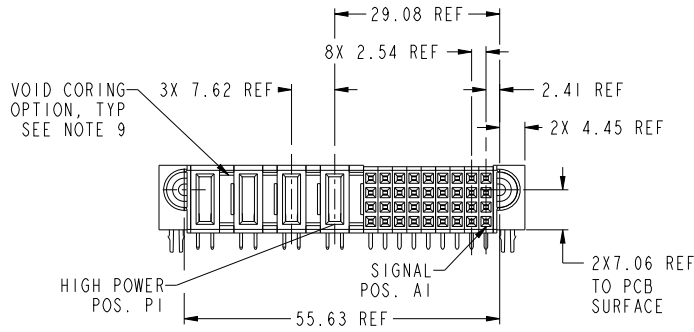
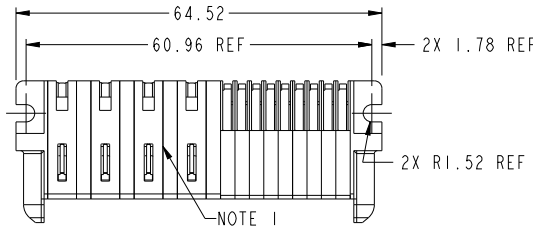

spec ref	-	dr	Xia Bob	20131209	projection	MM	size	A3	scale	3:2	
tolerance std	ASME Y14.5	eng	Xia Bob	20131209			ecn no	-	rel level	Released	
TOLERANCES UNLESS OTHERWISE SPECIFIED		chr	Li-Hu	20131209			product family	PwrBlade+			
surface	linear	appr	Pai-Ming Zhang	20131209			cat. no.	36S+4ACP	eng no	10106118-4009002	rev
	angular	www.fci.com			Product - Customer Drw		sheet 1 of 3				

Prod File - REV C - 2009-04-09

1

2

3

PDS: Rev A

STATUS: Released



Printed: Dec 04, 2013



Copyright FCI.

NOTES:

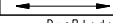
- 1) "FCI", PART NUMBER AND DATE CODE TO BE MARKED ON THIS SURFACE.
THE P/N CAN BE OMITTED IF THERE IS NOT ENOUGH SPACE ON THIS SURFACE.
- 2) MATERIALS:
-HOUSING - GLASS FILLED WITH HIGH TEMP THERMOPLASTIC, UL94V-0.
-SIGNAL CONTACT - COPPER ALLOY.
-POWER CONTACT - HIGH CONDUCTIVITY COPPER ALLOY.
- 3) PLATING SPECIFICATION REFER TO FCI 10116351
- 4) DENOTES CONNECTOR KEEP OUT ZONE.
- 5) DATUM AND BASIC DIMENSIONS WERE ESTABLISHED BY CUSTOMER.
- 6) ALL HOLE DIAMETERS ARE FINISHED HOLE SIZES.
- 7) 1.15 ± 0.025 MM DRILLED HOLE PLATED WITH 0.00762MM MIN Sn
OVER 0.0254-0.0762MM Cu PLATING TO ACHIEVE A 1.02 ± 0.07 MM HOLE.
- 8) PRODUCT SPECIFICATION REFER TO FCI GS-12-658.
APPLICATION SPECIFICATION REFER TO FCI GS-20-141.
PRODUCT PACKAGED IN TRAYS, REFER TO FCI GS-14-1502.
- 9) THE VOID CORING IN BETWEEN POWER MODULES, SIGNAL
MODULES AND END MODULES ARE OPTIONAL AND THE SHAPE
MAY BE DIFFERENT FOR OPTIMIZE THE MOLDING PROCESS. THE
VOID CORING WILL NOT EFFECT TO PRODUCT FUNCTION.

dr	Xia Bob	20131209	projection	MM	size	A3	scale	3:2
eng	Xia Bob	20131209			ecn no	-	rel level	
chr	Li He	20131209			product family	PwrBlade+	Released	
appr	Pai-Ming Zhang	20131209			cat. no.	10106118-4009002		rev
			title 36S+4ACP RA STB RECEPTACLE		Product - Customer Drw		sheet 3 of 3	
www.fci.com			3		PDS: Rev :A		STATUS:Released	



Copyright FCI.