

Excellent Integrated System Limited

Stocking Distributor

Click to view price, real time Inventory, Delivery & Lifecycle Information:

[Cinch Connectivity Solutions](#)
[ATT-0523-10-SMA-02](#)

For any questions, you can email us directly:

sales@integrated-circuit.com

- NOTES:
- 1.0 ELECTRICAL SPECIFICATIONS:
- 1.1 FREQUENCY RANGE: DC to 18.0 GHz
 - 1.2 ATTENUATION VALUES: 1 THRU 30dB IN 1dB INCREMENTS
 - 1.3 ATTENUATION ACCURACY:
 - 0dB +0.3/-0dB
 - 1 - 6 dB ±0.30dB
 - 7 - 20 dB ±0.5dB
 - 21 - 30dB ±1.0 dB
 - 1.4 MAXIMUM VSWR: 1.07 + 0.015f (GHz)
 - 1.5 MAXIMUM INPUT POWER: 2 WATTS AVG. AT +25°C DERATED LINEARLY TO 0.5 WATTS AT +125°C
 - 1.6 OPERATING TEMP. RANGE: -65°C to +125°C
 - 1.7 IMPEDANCE: 50 OHMS

- 2.0 MARKING: _____
- 2.1 MARK UNIT AS SHOWN (REF.: INK-04189-27-XX)

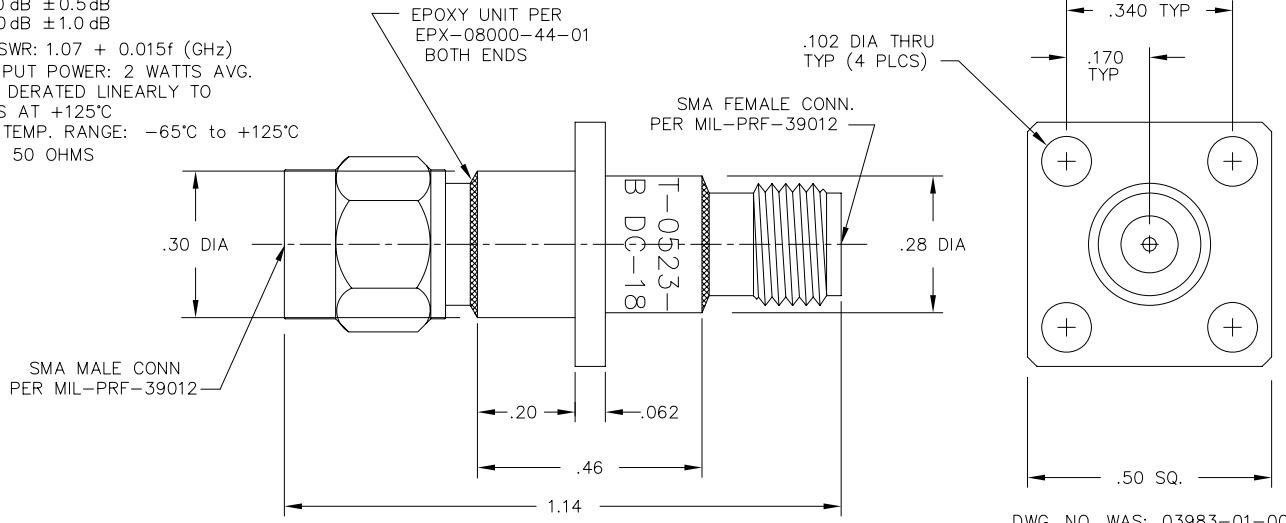

DWG. NO. WAS: 03983-01-00

MODEL NUMBER
ATT-0523-XX-SMA-02
REV.
G1

REV.	DESCRIPTION	DATE
1	RELEASED	5/10/82
A	ECR 1616	8/2/82
B	ECR 3603	5/22/85
C	ECR 6545 (RENUMBER)	7/20/88
D	ECN 10779	7/19/91
E	ECN 11260	11/26/91
F	ECN 12565	4/14/93
G	ECN 13324	2/10/94
G1	ADDED TITLEBLOCK	4/7/05

UNLESS OTHERWISE NOTED DIMENSIONS ARE IN INCHES AND TOLERANCES ARE: 3 PLACE DECIMALS ±.005 2 PLACE DECIMALS ±.02 FRACTIONS ±1/64 PARALLELITY: T.I.R. _____ FLATNESS: T.I.R. _____ CONCENTRICITY: T.I.R. _____ ANGLES AND PERPENDICULARITY: ±1°	FSCM NO. 34078	MIDWEST MICROWAVE
	NOTICE: The information contained in this drawing is proprietary and must not be used without the permission of Midwest Microwave	
	TITLE ATTENUATOR	DRAWING NUMBER ATT-0523-XX-SMA-02
	DRAWN/DATE A. BEATTY 7/19/91	ENG./DATE C. KOZAK 7/19/91
	CHECKED/DATE C. RICKARD 7/19/91	APPROVED/DATE _____ _____
	SCALE: 5=1	SHEET 1 of 1