

Excellent Integrated System Limited

Stocking Distributor

Click to view price, real time Inventory, Delivery & Lifecycle Information:

[Bel Fuse Inc.](#)
[M3933/25-59S](#)

For any questions, you can email us directly:
sales@integrated-circuit.com

- NOTES:
- 1.0 SPECIFICATIONS:
 - 1.1 FREQUENCY RANGE: SEE TABLE
 - 1.2 IMPEDANCE: 50 OHMS NOMINAL
 - 1.3 VSWR MAX.:
 - DC to 2.0 GHz 1.10:1
 - 2.0 to 4.0 GHz 1.15:1
 - 4.0 to 8.0 GHz: 1.20:1
 - 8.0 to 12.4 GHz: 1.25:1
 - 12.4 to 18.0 GHz: 1.35:1
 - 1.4 ATTENUATION & ACCURACY: SEE TABLE
 - 1.5 MAXIMUM INPUT POWER
 - 1.5.1 2 WATTS AVG. AT +25°C DERATED LINEARLY TO 0.5 WATTS AT +125°C
 - 1.5.2 500 WATTS PEAK
 - 1.6 OPERATING TEMP. RANGE: -55°C to +125°C
 - 1.7 WEIGHT: 0.45 Oz. MAX.
 - 2.0 MARKING:
 - 2.1 ENGRAVE SERIAL NO. AND DATE CODE ON NUT AS SHOWN.
 - 2.2 MARK BODY AS SHOWN. (REF: INK-09119-27-XX) FOR NON-SCREENED. (REF: INK-09120-27-XX) FOR SCREENED.
 - 3.0 TESTING:

TEST IN CONJUNCTION WITH:

 - ATP-07839-60-01 FOR SCREENED UNITS.
 - ATP-09210-60-01 FOR NON-SCREENED UNITS.

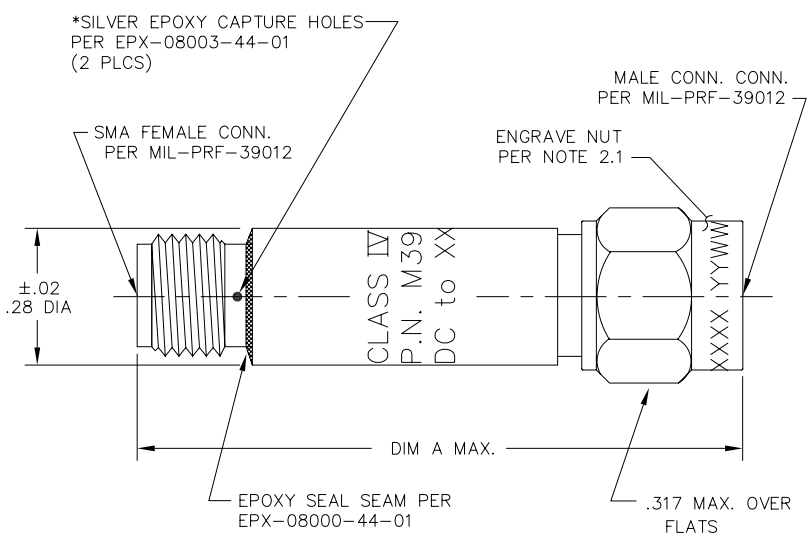

REV.	DESCRIPTION	DATE
I	RELEASED	7/14/92
A	13000	10/8/93
B	ECN 13307	2/4/94
C	ECN 13483	4/8/94
D	ECN 14231	1/16/95
E	ECN 18866	12/12/02
F	ECN 19058	2/25/03
G	ECN 19711	3/19/04
H	ECN 20764	3/10/06

4.0 BAG MARKING:

MODEL M3933/25-YYY
 ATTENUATOR FIXED COAXIAL LINE
 2 WATTS AVERAGE INPUT POWER
 FREQ. RANGE: DC-XX GHz
 MFR 34078
 LOT NO. _____
 DATE CODE: YYWW

SEE MODEL NO. FOR LAST 3 DIGITS

SEE TABLE ON SHT. 2

YEAR & WEEK

*N/A ON UNITS .94 O.A.L.

UNLESS OTHERWISE NOTED DIMENSIONS ARE IN INCHES AND TOLERANCES ARE: 3 PLACE DECIMALS ±.005 2 PLACE DECIMALS ±.02 FRACTIONS ±1/64 PARALLELITY: T.I.R. _____ FLATNESS: T.I.R. _____ CONCENTRICITY: T.I.R. _____ ANGLES AND PERPENDICULARITY: ±1°	FSCM NO. 34078	MIDWEST MICROWAVE
	NOTICE: The information contained in this drawing is proprietary and must not be used without the permission of Midwest Microwave TITLE ATTENUATOR	
DRAWN/DATE M. HOLLMAN 7/3/92 CHECKED/DATE G. KOZAK 7/14/92	ENG/DATE G. KOZAK 7/14/92 APPROVED/DATE	DRAWING NUMBER M3933/25-XX(N or S) SCALE: 5=1 SHEET 1 of 2



MODEL NUMBER
M3933/25-XX(N or S)
REV. H

DASH NO.	ATTENUATION dB				DIM A INCHES (MM) MAX.
	NOMINAL	DEVIATION (±)			
		DC to 2.0 GHz	DC to 12.4 GHz	DC to 18.0 GHz	
01 N/S	1	0.3			0.87 (22.10)
02 N/S	2	0.3			0.87 (22.10)
03 N/S	3	0.3			0.87 (22.10)
04 N/S	4	0.3			0.87 (22.10)
05 N/S	5	0.3			0.87 (22.10)
06 N/S	6	0.3			0.87 (22.10)
07 N/S	7	0.3			0.87 (22.10)
08 N/S	8	0.3			0.87 (22.10)
09 N/S	9	0.3			0.87 (22.10)
10 N/S	10	0.3			0.87 (22.10)
11 N/S	11	0.3			0.87 (22.10)
12 N/S	12	0.3			0.87 (22.10)
13 N/S	13	0.3			1.03 (26.16)
14 N/S	14	0.3			1.03 (26.16)
15 N/S	15	0.3			1.03 (26.16)
16 N/S	16	0.3			1.03 (26.16)
17 N/S	17	0.3			1.03 (26.16)
18 N/S	18	0.3			1.03 (26.16)
19 N/S	19	0.3			1.03 (26.16)
20 N/S	20	0.3			1.03 (26.16)
21 N/S	21	0.5			1.03 (26.16)
22 N/S	22	0.5			1.03 (26.16)
23 N/S	23	0.5			1.03 (26.16)
24 N/S	24	0.5			1.03 (26.16)
25 N/S	25	0.5			1.03 (26.16)
26 N/S	30	0.5			1.03 (26.16)
27 N/S	1		0.3		0.87 (22.10)
28 N/S	2		0.3		0.87 (22.10)
29 N/S	3		0.3		0.87 (22.10)
30 N/S	4		0.3		0.87 (22.10)
31 N/S	5		0.3		0.87 (22.10)
32 N/S	6		0.3		0.87 (22.10)

DASH NO.	ATTENUATION dB				DIM A INCHES (MM) MAX.
	NOMINAL	DEVIATION (±)			
		DC to 2.0 GHz	DC to 12.4 GHz	DC to 18.0 GHz	
33 N/S	7		0.4		0.87 (22.10)
34 N/S	8		0.4		0.87 (22.10)
35 N/S	9		0.4		0.87 (22.10)
36 N/S	10		0.4		0.87 (22.10)
37 N/S	11		0.4		0.87 (22.10)
38 N/S	12		0.4		0.87 (22.10)
39 N/S	13		0.4		0.94 (23.88)
40 N/S	14		0.4		0.94 (23.88)
41 N/S	15		0.4		0.94 (23.88)
42 N/S	16		0.4		0.94 (23.88)
43 N/S	17		0.4		0.94 (23.88)
44 N/S	18		0.4		0.94 (23.88)
45 N/S	19		0.4		0.94 (23.88)
46 N/S	20		0.7		1.04 (26.42)
47 N/S	21		0.7		1.04 (26.42)
48 N/S	22		0.7		1.04 (26.42)
49 N/S	23		0.7		1.04 (26.42)
50 N/S	24		0.7		1.04 (26.42)
51 N/S	25		0.7		1.04 (26.42)
52 N/S	30		1.0		1.04 (26.42)
53 N/S	35		1.0		1.35 (34.29)
54 N/S	40		1.0		1.35 (34.29)
55 N/S	45		1.5		1.35 (34.29)
56 N/S	50		2.0		1.35 (34.29)
57 N/S	60		2.0		1.35 (34.29)
58 N/S	0			0.3	0.87 (22.10)
59 N/S	0.5			0.3	0.87 (22.10)
60 N/S	1.0			0.3	0.87 (22.10)
61 N/S	1.5			0.3	0.87 (22.10)
62 N/S	2.0			0.3	0.87 (22.10)
63 N/S	2.5			0.3	0.87 (22.10)
64 N/S	3.0			0.3	0.87 (22.10)

DASH NO.	ATTENUATION dB				DIM A INCHES (MM) MAX.
	NOMINAL	DEVIATION (±)			
		DC to 2.0 GHz	DC to 12.4 GHz	DC to 18.0 GHz	
65 N/S	3.5			0.3	0.87 (22.10)
66 N/S	4.0			0.3	0.87 (22.10)
67 N/S	4.5			0.3	0.87 (22.10)
68 N/S	5.0			0.3	0.87 (22.10)
69 N/S	5.5			0.3	0.87 (22.10)
70 N/S	6.0			0.3	0.87 (22.10)
71 N/S	6.5			0.3	0.87 (22.10)
72 N/S	7.0			0.4	0.87 (22.10)
73 N/S	7.5			0.4	0.87 (22.10)
74 N/S	8.0			0.4	0.87 (22.10)
75 N/S	8.5			0.4	0.87 (22.10)
76 N/S	9.0			0.5	0.87 (22.10)
77 N/S	9.5			0.5	0.87 (22.10)
78 N/S	10.0			0.5	0.87 (22.10)
79 N/S	11.0			0.5	0.87 (22.10)
80 N/S	12.0			0.5	0.87 (22.10)
81 N/S	13.0			0.5	0.94 (23.88)
82 N/S	14.0			0.5	0.94 (23.88)
83 N/S	15.0			0.6	1.04 (26.42)
84 N/S	16.0			0.6	1.04 (26.42)
85 N/S	17.0			0.6	1.04 (26.42)
86 N/S	18.0			0.6	1.04 (26.42)
87 N/S	19.0			0.6	1.04 (26.42)
88 N/S	20.0			0.6	1.04 (26.42)
89 N/S	25.0			1.0	1.04 (26.42)
90 N/S	30.0			1.0	1.04 (26.42)
91 N/S	35.0			1.0	1.35 (34.29)
92 N/S	40.0			1.0	1.35 (34.29)
93 N/S	45.0			1.0	1.35 (34.29)
94 N/S	50.0			2.0	1.35 (34.29)
95 N/S	60.0			2.0	1.35 (34.29)

DATE	7/14/92
DESCRIPTION	RELEASED
REV.	1

UNLESS OTHERWISE NOTED DIMENSIONS ARE IN INCHES AND TOLERANCES ARE: 3 PLACE DECIMALS ±.005 2 PLACE DECIMALS ±.02 FRACTIONS ±1/64 PARALLELITY: T.I.R. _____ FLATNESS: T.I.R. _____ CONCENTRICITY: T.I.R. _____ ANGLES AND PERPENDICULARITY: ±1'	FSCM NO. 34078	MIDWEST MICROWAVE
	NOTICE: The information contained in this drawing is proprietary and must not be used without the permission of Midwest Microwave	TITLE ATTENUATOR
DRAWN/DATE M.HOLLMAN 7/3/92	ENG/DATE G.KOZAK 7/14/92	DRAWING NUMBER M3933/25-XX(N or S)
CHECKED/DATE G.KOZAK 7/14/92	APPROVED/DATE	SCALE: 1=1 SHEET 2 of 2