

Excellent Integrated System Limited

Stocking Distributor

Click to view price, real time Inventory, Delivery & Lifecycle Information:

[Molex Connector Corporation](#)
[1510492201](#)

For any questions, you can email us directly:

sales@integrated-circuit.com

10 9 8 7 6 5 4 3 2 1

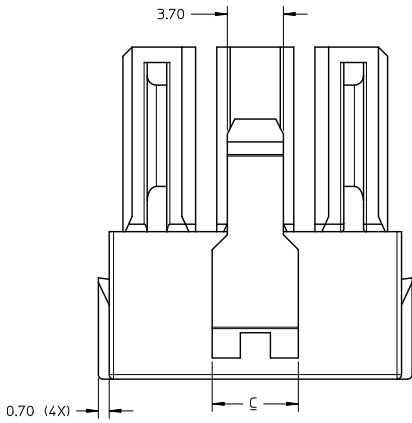
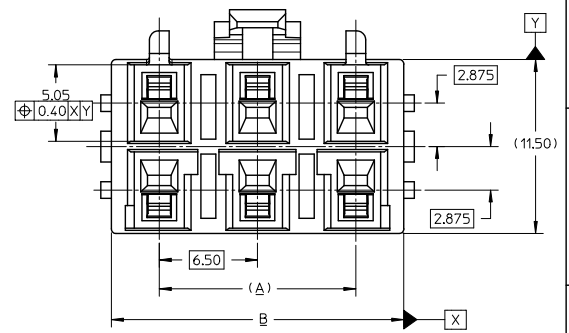
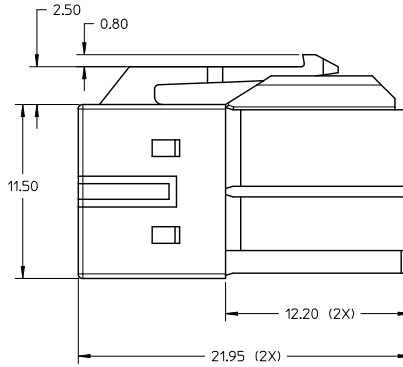
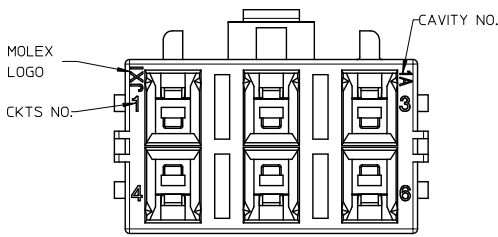

PART NO. LEGEND	
151049 - * * * *	COLOR
	CKT NO.
	OTHERS

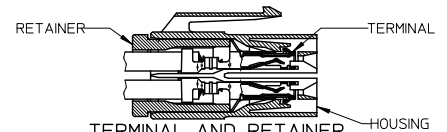

TERMINAL AND RETAINER ASSEMBLY DRAWING

NOTES:

- MATERIAL: HOUSING: PBTP, UL94V-0
- APPLICATION TERMINAL : 50597 (FOR WIRE RANGE #16-#22) 50598 (FOR WIRE RANGE #20-#26)
- APPLICATION RETAINER : 51143
- REFER TO COSMETIC SPECIFICATION: PS-45499-002(CLASS B)
- MATE WITH HEADER 151048 SERIES
- PRODUCT SPECIFICATION: PS-151048-0001
- PACKAGING SPECIFICATION: PK-151049-0001

6	13.00	19.34	5.70	REFER TO PG 4
4	6.50	12.84	3.70	REFER TO PG 3
2	-	6.34	5.70	REFER TO PG 2
CKT. NO.	A	B	C	MATERIAL NO.

UPDATE DRAWING EC NO: S2015-1136 DRAWN BY: CHYKDCGH CHKD: CGOH APPR: KHLIM	DESCRIPTION REV	QUALITY SYMBOLS ▽=0 ▽=0 ▽=0	GENERAL TOLERANCES (UNLESS SPECIFIED)		DIMENSION STYLE	SCALE	DESIGN UNITS	THIRD ANGLE PROJECTION
			mm	INCH	MM ONLY	NTS	METRIC	
6			4 PLACES	± ---	± ---	EANG	2014/03/13	
			3 PLACES	± ---	± ---	C6GH	2015/03/12	
			2 PLACES	± 0.20	± ---			
			1 PLACE	± ---	± ---			
			0 PLACE	± ---	± ---			
			ANGULAR ± 3 °		MATERIAL NO.		DOCUMENT NO.	
			DRAFT WHERE APPLICABLE MUST REMAIN WITHIN DIMENSIONS		SEE TABLE		SD-151049-0001	
					SIZE A3		THIS DRAWING CONTAINS INFORMATION THAT IS PROPRIETARY TO MOLEX INCORPORATED AND SHOULD NOT BE USED WITHOUT WRITTEN PERMISSION	

SALES DRAWING
6.5 RECEPTACLE HOUSING
WIRE TO BOARD CONNECTOR

molex

SHEET NO.
1 OF 4

9 8 7 6 5 4 3 2 1

HOUSING WITH POLARIZATION FEATURES AND COLOR FOR 2CKTS

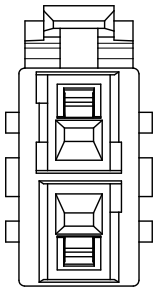

① 1510492200 ORANGE

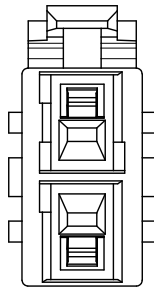

② 1510492201 BLUE

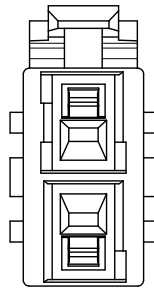

③ 1510492202 GREY

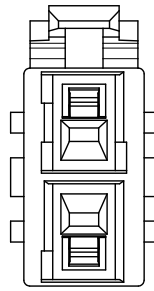

④ 1510492203 YELLOW

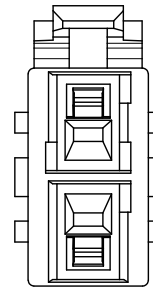

⑤ 1510492204 PURPLE

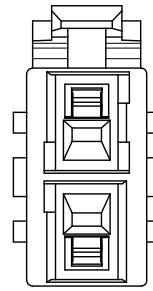

⑥ 1510492205 PINK

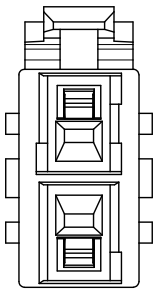

⑦ 1510492206 BLACK

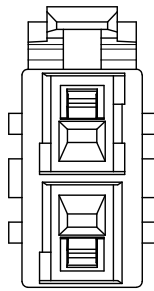

⑧ 1510492207 GREEN

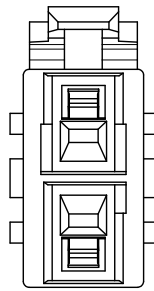

⑨ 1510492208 BROWN

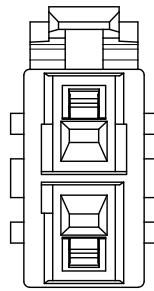

⑩ 1510492209 RED

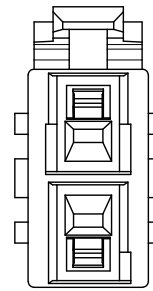

⑪ 1510492210 MINT

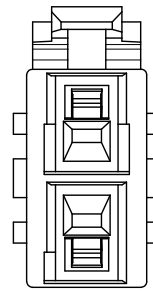

⑫ 1510492211 NATURAL (WHITE)

1	1510492200	ORANGE	*	
2	1510492201	BLUE	*	
3	1510492202	GREY		*
4	1510492203	YELLOW	*	
5	1510492204	PURPLE		*
6	1510492205	PINK		*
7	1510492206	BLACK	*	
8	1510492207	GREEN		*
9	1510492208	BROWN		*
10	1510492209	RED	*	
11	1510492210	MINT		*
12	1510492211	NATURAL (WHITE)	*	

CONFIGURATION	ASSEMBLY	COLOR	STANDARD COLOR	CUSTOM COLOR
---------------	----------	-------	----------------	--------------

UPDATE DRAWING	2015/07/10
EC NO. S2015-1136	2015/07/21
DRAWING	2015/07/21
CHKD:CGOH	2015/07/22
APPR:KLLIM	
REV	DESCRIPTION
6	QUALITY SYMBOLS

GENERAL TOLERANCES (UNLESS SPECIFIED)	
	mm INCH
4 PLACES	± --- ± ---
3 PLACES	± --- ± ---
2 PLACES	± 0.20 ± ---
1 PLACE	± --- ± ---
0 PLACE	± --- ± ---
ANGULAR ± 3°	
DRAFT WHERE APPLICABLE MUST REMAIN WITHIN DIMENSIONS	

DIMENSION STYLE	
MM ONLY	
DRAWN BY	DATE
EANG	2014/03/13
CHECKED BY	DATE
CGOH	2015/03/12
APPROVED BY	DATE
KHL IM	2015/03/16
MATERIAL NO.	SEE TABLE

SCALE	DESIGN UNITS	THIRD ANGLE PROJECTION
NTS	METRIC	
SALES DRAWING		
6.5 RECEPTACLE HOUSING		
WIRE TO BOARD CONNECTOR		
molex		
DOCUMENT NO.	SD-151049-0001	SHEET NO.
		2 OF 4

10 9 8 7 6 5 4 3 2 1

HOUSING WITH POLARIZATION FEATURES AND COLOR FOR 4CKTS

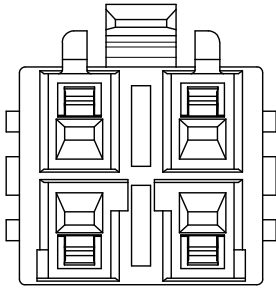

① 1510492401
BLUE

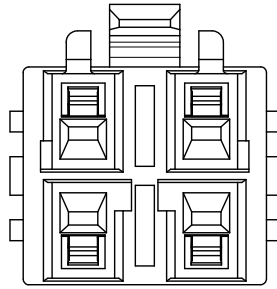

② 1510492406
BLACK

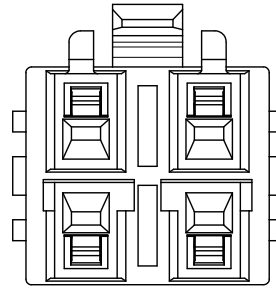

③ 1510492411
NATURAL (WHITE)

1	1510492401	BLUE
2	1510492406	BLACK
3	1510492411	NATURAL (WHITE)
CONFIGURATION	ASSEMBLY	COLOR

fb_frame_A3_P_AM_T
Rev. G 2012/01/11

UPDATE DRAWING EC NO: S2015-1136 DRAWING: 2015/07/10 CHKD: CGOH 2015/07/21 APPR: KHLIM 2015/07/22 REV 6	QUALITY SYMBOLS	GENERAL TOLERANCES (UNLESS SPECIFIED)	DIMENSION STYLE	SCALE	DESIGN UNITS	THIRD ANGLE PROJECTION
	$\nabla=0$ $\nabla=0$ $\nabla=0$	mm INCH 4 PLACES ± --- ± --- 3 PLACES ± --- ± --- 2 PLACES ± 0.20 ± --- 1 PLACE ± --- ± --- 0 PLACE ± --- ± ---	MM ONLY	NTS	METRIC	◎ □ THIRD ANGLE PROJECTION
		ANGULAR ± 3°	DRAWN BY	DATE	TITLE	
		DRAFT WHERE APPLICABLE MUST REMAIN WITHIN DIMENSIONS	EANG	2014/03/13	SALES DRAWING	
			CHECKED BY	DATE	6.5 RECEPTACLE HOUSING	
			CGOH	2015/03/12	WIRE TO BOARD CONNECTOR	
		APPROVED BY	DATE	molex		
		KHLIM	2015/03/16	DOCUMENT NO.	SD-151049-0001	
		MATERIAL NO.	SEE TABLE	SHEET NO.	3 OF 4	
		SIZE	A3	THIS DRAWING CONTAINS INFORMATION THAT IS PROPRIETARY TO MOLEX INCORPORATED AND SHOULD NOT BE USED WITHOUT WRITTEN PERMISSION		

9 8 7 6 5 4 3 2 1

10 9 8 7 6 5 4 3 2 1

HOUSING WITH POLARIZATION FEATURES AND COLOR FOR 6CKTS

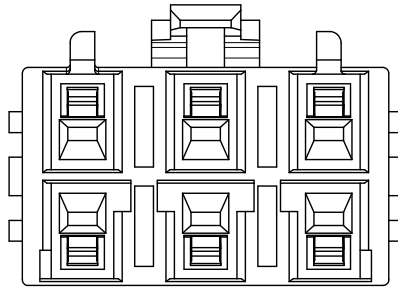

① 1510492601
BLUE

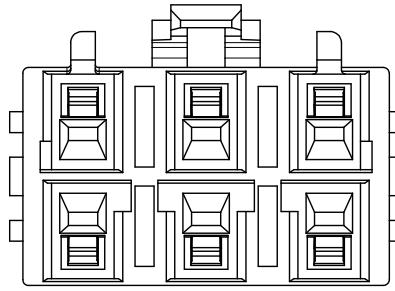

② 1510492606
BLACK

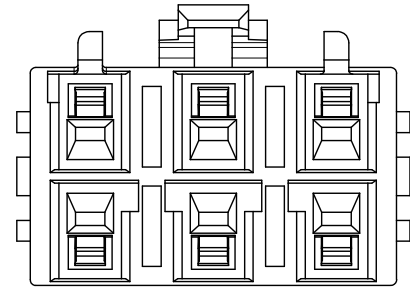

③ 1510492609
RED

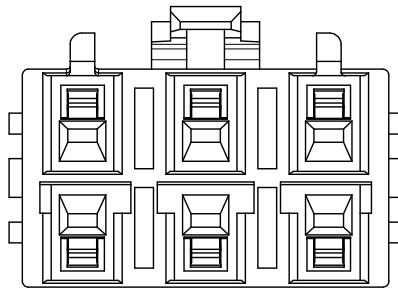

④ 1510492611
NATURAL (WHITE)

1	1510492601	BLUE
2	1510492606	BLACK
3	1510492609	RED
4	1510492611	NATURAL (WHITE)
CONFIGURATION	ASSEMBLY	COLOR

UPDATE DRAWING EC NO: S2015-1136 DRAWING: 2015/07/10 CHKD: CGOH 2015/07/21 APPR: KHLIM 2015/07/22 REV 6	QUALITY SYMBOLS	GENERAL TOLERANCES (UNLESS SPECIFIED)	DIMENSION STYLE	SCALE	DESIGN UNITS	THIRD ANGLE PROJECTION
	$\nabla=0$ $\nabla=0$ $\nabla=0$	mm INCH 4 PLACES ± --- ± --- 3 PLACES ± --- ± --- 2 PLACES ± 0.20 ± --- 1 PLACE ± --- ± --- 0 PLACE ± --- ± ---	MM ONLY	NTS	METRIC	TITLE SALES DRAWING 6.5 RECEPTACLE HOUSING WIRE TO BOARD CONNECTOR molex DOCUMENT NO. SD-151049-0001 SHEET NO. 4 OF 4
		ANGULAR ± 3°				
		DRAFT WHERE APPLICABLE MUST REMAIN WITHIN DIMENSIONS				
			SEE TABLE			
			THIS DRAWING CONTAINS INFORMATION THAT IS PROPRIETARY TO MOLEX INCORPORATED AND SHOULD NOT BE USED WITHOUT WRITTEN PERMISSION			

9 8 7 6 5 4 3 2 1