

Excellent Integrated System Limited

Stocking Distributor

Click to view price, real time Inventory, Delivery & Lifecycle Information:

[Molex Connector Corporation](#)
[1510492606](#)

For any questions, you can email us directly:

sales@integrated-circuit.com

10 9 8 7 6 5 4 3 2 1

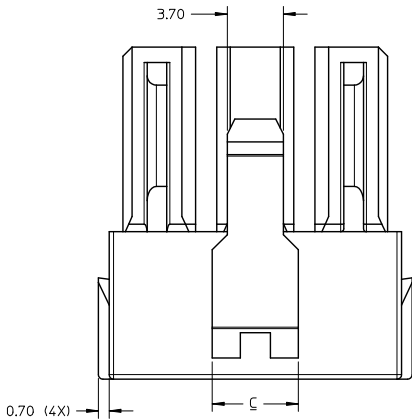
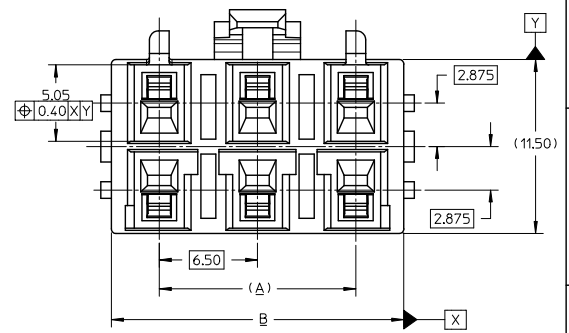
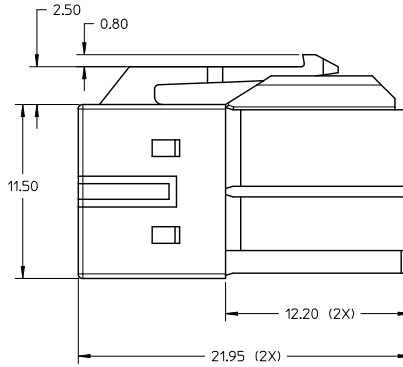
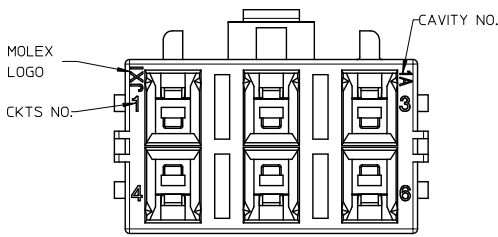

PART NO. LEGEND	
151049 - * * * *	COLOR
	CKT NO.
	OTHERS

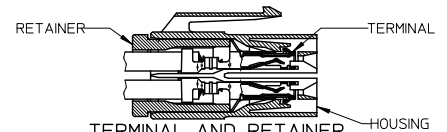

TERMINAL AND RETAINER ASSEMBLY DRAWING

NOTES:

- MATERIAL: HOUSING: PBTP, UL94V-0
- APPLICATION TERMINAL : 50597 (FOR WIRE RANGE #16-#22) 50598 (FOR WIRE RANGE #20-#26)
- APPLICATION RETAINER : 51143
- REFER TO COSMETIC SPECIFICATION: PS-45499-002(CLASS B)
- MATE WITH HEADER 151048 SERIES
- PRODUCT SPECIFICATION: PS-151048-0001
- PACKAGING SPECIFICATION: PK-151049-0001

6	13.00	19.34	5.70	REFER TO PG 4
4	6.50	12.84	3.70	REFER TO PG 3
2	-	6.34	5.70	REFER TO PG 2
CKT. NO.	A	B	C	MATERIAL NO.

UPDATE DRAWING EC NO: S2015-1136 DRAWN BY: CHYD:CGOH CHKD:CGOH APPR:KHL:IM	DESCRIPTION REV	QUALITY SYMBOLS √=0 ∇=0 ∇=0	GENERAL TOLERANCES (UNLESS SPECIFIED)		DIMENSION STYLE	SCALE	DESIGN UNITS	THIRD ANGLE PROJECTION
			mm	INCH	MM ONLY	NTS	METRIC	
			4 PLACES	± ---	± ---	DRAWN BY: EANG	DATE: 2014/03/13	SALES DRAWING 6.5 RECEPTACLE HOUSING WIRE TO BOARD CONNECTOR
			3 PLACES	± ---	± ---	CHECKED BY: CGOH	DATE: 2015/03/12	
			2 PLACES	± 0.20	± ---	APPROVED BY: KHL:IM	DATE: 2015/03/16	
			1 PLACE	± ---	± ---	MATERIAL NO.	DATE: 2015/03/16	
			0 PLACE	± ---	± ---	SEE TABLE	DOCUMENT NO. SD-151049-0001	SHEET NO. 1 OF 4
DRAFT WHERE APPLICABLE MUST REMAIN WITHIN DIMENSIONS			ANGULAR ± 3 °		THIS DRAWING CONTAINS INFORMATION THAT IS PROPRIETARY TO MOLEX INCORPORATED AND SHOULD NOT BE USED WITHOUT WRITTEN PERMISSION			

9 8 7 6 5 4 3 2 1

HOUSING WITH POLARIZATION FEATURES AND COLOR FOR 2CKTS

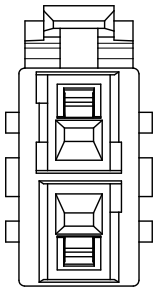

① 1510492200 ORANGE

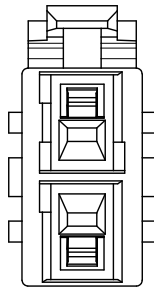

② 1510492201 BLUE

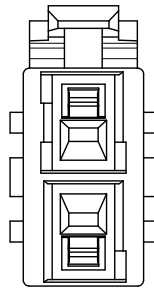

③ 1510492202 GREY

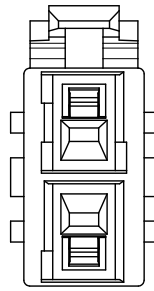

④ 1510492203 YELLOW

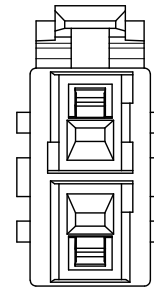

⑤ 1510492204 PURPLE

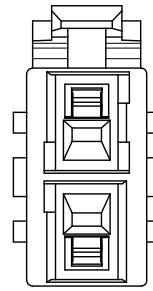

⑥ 1510492205 PINK

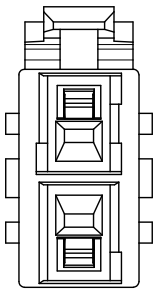

⑦ 1510492206 BLACK

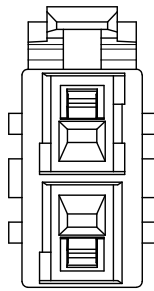

⑧ 1510492207 GREEN

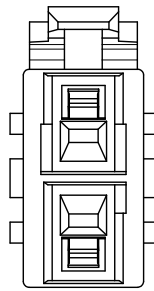

⑨ 1510492208 BROWN

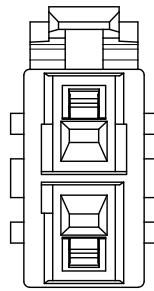

⑩ 1510492209 RED

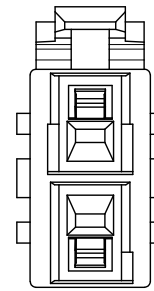

⑪ 1510492210 MINT

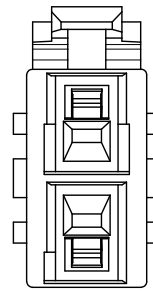

⑫ 1510492211 NATURAL (WHITE)

1	1510492200	ORANGE	*	
2	1510492201	BLUE	*	
3	1510492202	GREY		*
4	1510492203	YELLOW	*	
5	1510492204	PURPLE		*
6	1510492205	PINK		*
7	1510492206	BLACK	*	
8	1510492207	GREEN		*
9	1510492208	BROWN		*
10	1510492209	RED	*	
11	1510492210	MINT		*
12	1510492211	NATURAL (WHITE)	*	

CONFIGURATION	ASSEMBLY	COLOR	STANDARD COLOR	CUSTOM COLOR
---------------	----------	-------	----------------	--------------

UPDATE DRAWING
 EC NO: S2015-1136
 DRAWING: 2015/07/10
 CHKD:CGOH 2015/07/21
 APPR:KLLIM 2015/07/22

REV	DESCRIPTION
6	

QUALITY SYMBOLS	
$\sqrt{0}$	
$\sqrt{0}$	
$\sqrt{0}$	

GENERAL TOLERANCES (UNLESS SPECIFIED)	
	mm
4 PLACES	±---
3 PLACES	±---
2 PLACES	±0.20
1 PLACE	±---
0 PLACE	±---
ANGULAR ± 3°	

DIMENSION STYLE	
MM ONLY	
DRAWN BY	DATE
EANG	2014/03/13
CHECKED BY	DATE
CGOH	2015/03/12
APPROVED BY	DATE
KHLIM	2015/03/16

SCALE	DESIGN UNITS	THIRD ANGLE PROJECTION
NTS	METRIC	
SALES DRAWING 6.5 RECEPTACLE HOUSING WIRE TO BOARD CONNECTOR		
molex		
MATERIAL NO.	DOCUMENT NO.	SHEET NO.
SEE TABLE	SD-151049-0001	2 OF 4

10 9 8 7 6 5 4 3 2 1

HOUSING WITH POLARIZATION FEATURES AND COLOR FOR 4CKTS

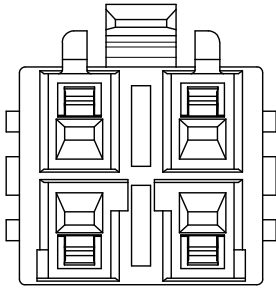

① 1510492401
BLUE

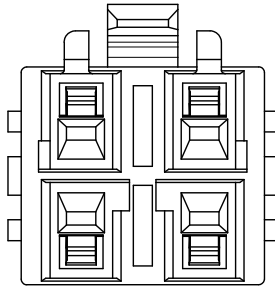

② 1510492406
BLACK

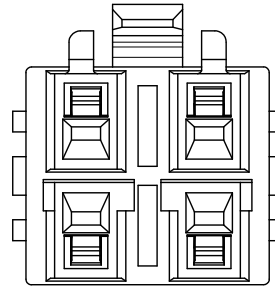

③ 1510492411
NATURAL (WHITE)

1	1510492401	BLUE
2	1510492406	BLACK
3	1510492411	NATURAL (WHITE)
CONFIGURATION	ASSEMBLY	COLOR

fb_frame_A3_P_AM_T
Rev. G 2012/01/11

UPDATE DRAWING EC NO: S2015-1136 DRAWING: 2015/07/10 CHKD:CGOH 2015/07/21 APPR:KHLIM 2015/07/22 REV 6	QUALITY SYMBOLS	GENERAL TOLERANCES (UNLESS SPECIFIED)	DIMENSION STYLE	SCALE	DESIGN UNITS	THIRD ANGLE PROJECTION	
	$\nabla=0$ $\nabla=0$ $\nabla=0$	mm INCH 4 PLACES ± --- ± --- 3 PLACES ± --- ± --- 2 PLACES ± 0.20 ± --- 1 PLACE ± --- ± --- 0 PLACE ± --- ± ---	MM ONLY	NTS	METRIC	DRAWN BY: EANG DATE: 2014/03/13 CHECKED BY: CGOH DATE: 2015/03/12 APPROVED BY: KHLIM DATE: 2015/03/16	TITLE: SALES DRAWING 6.5 RECEPTACLE HOUSING WIRE TO BOARD CONNECTOR
		ANGULAR ± 3°				MATERIAL NO.	DOCUMENT NO.
		DRAFT WHERE APPLICABLE MUST REMAIN WITHIN DIMENSIONS		SEE TABLE			SD-151049-0001
				SIZE: A3		THIS DRAWING CONTAINS INFORMATION THAT IS PROPRIETARY TO MOLEX INCORPORATED AND SHOULD NOT BE USED WITHOUT WRITTEN PERMISSION	
							SHEET NO. 3 OF 4

9 8 7 6 5 4 3 2 1

10 9 8 7 6 5 4 3 2 1

HOUSING WITH POLARIZATION FEATURES AND COLOR FOR 6CKTS

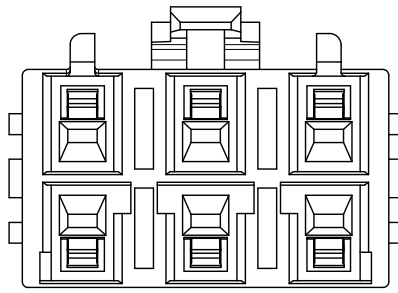

① 1510492601
BLUE

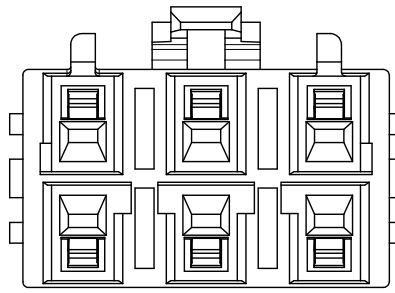

② 1510492606
BLACK

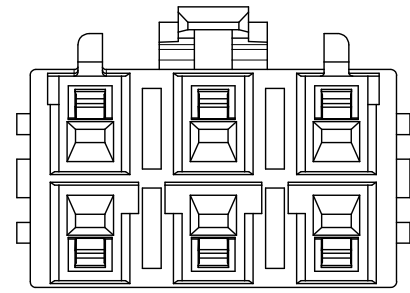

③ 1510492609
RED

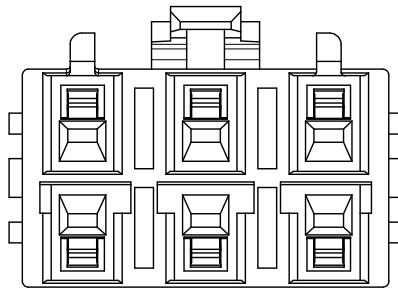

④ 1510492611
NATURAL (WHITE)

1	1510492601	BLUE
2	1510492606	BLACK
3	1510492609	RED
4	1510492611	NATURAL (WHITE)
CONFIGURATION	ASSEMBLY	COLOR

UPDATE DRAWING EC NO: S2015-1136 DRAWING: 2015/07/10 CHKD: CGOH 2015/07/21 APPR: KHLIM 2015/07/22 REV 6	QUALITY SYMBOLS √=0 √=0 √=0	GENERAL TOLERANCES (UNLESS SPECIFIED) <table border="1"> <tr> <td></td> <td>mm</td> <td>INCH</td> </tr> <tr> <td>4 PLACES</td> <td>± ---</td> <td>± ---</td> </tr> <tr> <td>3 PLACES</td> <td>± ---</td> <td>± ---</td> </tr> <tr> <td>2 PLACES</td> <td>± 0.20</td> <td>± ---</td> </tr> <tr> <td>1 PLACE</td> <td>± ---</td> <td>± ---</td> </tr> <tr> <td>0 PLACE</td> <td>± ---</td> <td>± ---</td> </tr> </table> ANGULAR ± 3° DRAFT WHERE APPLICABLE MUST REMAIN WITHIN DIMENSIONS		mm	INCH	4 PLACES	± ---	± ---	3 PLACES	± ---	± ---	2 PLACES	± 0.20	± ---	1 PLACE	± ---	± ---	0 PLACE	± ---	± ---	DIMENSION STYLE MM ONLY DRAWN BY DATE EANG 2014/03/13 CHECKED BY DATE CGOH 2015/03/12 APPROVED BY DATE KHLIM 2015/03/16	SCALE NTS DESIGN UNITS METRIC THIRD ANGLE PROJECTION	TITLE SALES DRAWING 6.5 RECEPTACLE HOUSING WIRE TO BOARD CONNECTOR molex MATERIAL NO. SEE TABLE DOCUMENT NO. SD-151049-0001 SHEET NO. 4 OF 4
		mm	INCH																				
	4 PLACES	± ---	± ---																				
	3 PLACES	± ---	± ---																				
	2 PLACES	± 0.20	± ---																				
	1 PLACE	± ---	± ---																				
0 PLACE	± ---	± ---																					
THIS DRAWING CONTAINS INFORMATION THAT IS PROPRIETARY TO MOLEX INCORPORATED AND SHOULD NOT BE USED WITHOUT WRITTEN PERMISSION																							

9 8 7 6 5 4 3 2 1