

## **Excellent Integrated System Limited**

Stocking Distributor

Click to view price, real time Inventory, Delivery & Lifecycle Information:

[Molex Connector Corporation](#)  
[43650-1004](#)

For any questions, you can email us directly:

[sales@integrated-circuit.com](mailto:sales@integrated-circuit.com)

CKTS	DIM A	DIM B	DIM C
2	.380 9.65	.118 3.00	.287 7.30
3	.498 12.65	.236 6.00	.405 10.30
4	.616 15.65	.354 9.00	.524 13.30
5	.734 18.64	.472 12.00	.642 16.30
6	.852 21.64	.591 15.00	.760 19.30
7	.970 24.64	.709 18.00	.878 22.30
8	1.088 27.64	.827 21.00	.996 25.30
9	1.206 30.63	.945 24.00	1.114 28.30
10	1.325 33.66	1.063 27.00	1.232 31.30
11	1.443 36.65	1.181 30.00	1.350 34.30
12	1.561 39.65	1.299 33.00	1.469 37.30

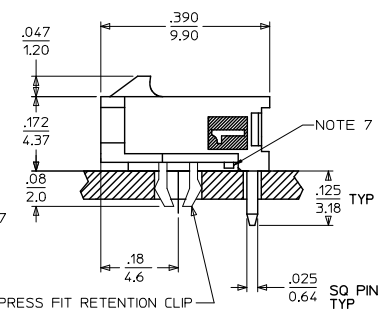
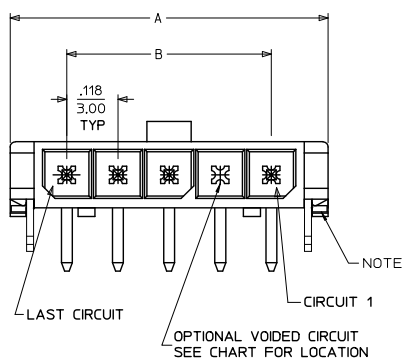
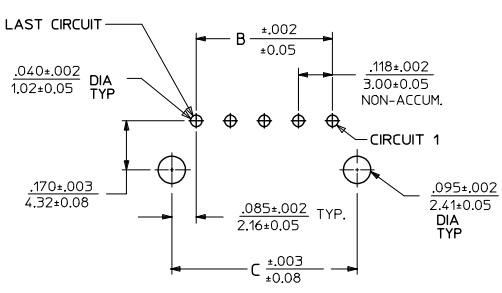
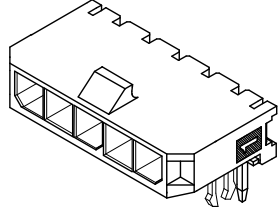
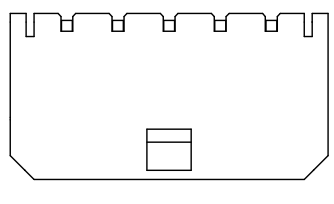

PCB LAYOUT: COMPONENT SIDE  
RECOMMENDED PCB THICKNESS: .062/1.57

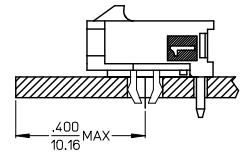

LOCATION DETAIL  
SEE NOTE #6

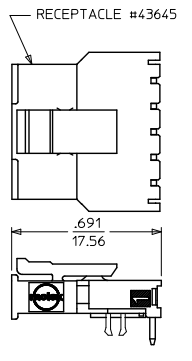

MATED MICRO FIT CONNECTOR

- NOTES:
- HOUSING MATERIAL: LIQUID CRYSTAL POLYMER, GLASS FILLED, UL94V-0, COLOR: BLACK  
TERMINAL MATERIAL: BRASS ALLOY
  - FINISH:  
A = .000060/(0.00152) MIN. REFLOWED MATTE TIN OVER .000050/(0.00127) MIN. NICKEL OVERALL (FINISH IS BRIGHT IN APPEARANCE, THICKNESS AS APPLIED PRIOR TO REFLOW)  
B = .000015/(0.00038) MIN. SELECT GOLD IN CONTACT AREA .000100/(0.00254) MIN. SELECT MATTE TIN ON SOLDER TAILS BOTH OVER .000050/(0.00127) MIN. NICKEL OVERALL  
C = .000030/(0.00076) MIN. SELECT GOLD IN CONTACT AREA .000100/(0.00254) MIN. SELECT MATTE TIN ON SOLDER TAILS BOTH OVER .000050/(0.00127) MIN. NICKEL OVERALL  
D = .000100/(0.00254) MIN. MATTE TIN OVER .000050/(0.00127) MIN. NICKEL OVERALL
  - PRODUCT SPECIFICATION: PS-43650
  - TRAY PACKAGED : SEE MOLEX DRAWING PK-70873-0321
  - MATES WITH MICRO FIT (3.0) RECEPTACLE SERIES 43645
  - TO AVOID INTERFERENCE BETWEEN RECEPTACLE AND PCB, HEADER MUST BE PLACED WITHIN .400/(10.16) MAX. FROM EDGE OF PCB, AS SHOWN IN LOCATION DETAIL.
  - METAL TAB MAY BE FLUSH WITH PCB.
  - PART CONFORMS TO CLASS 'B' REQUIREMENTS OF COSMETIC SPECIFICATION' PS-45499-002.

CKTS	FINISH A		FINISH B		FINISH C		FINISH D	
	MATERIAL NO:	VOID CKT	MATERIAL NO:	VOID CKT	MATERIAL NO:	VOID CKT	MATERIAL NO:	VOID CKT
02	43650-0203		43650-0204		43650-0205		43650-0259	
03	43650-0303		43650-0304		43650-0305		43650-0359	
04	43650-0403		43650-0404		43650-0405		43650-0459	
05	43650-0503		43650-0504		43650-0505		43650-0559	
06	43650-0603		43650-0604		43650-0605		43650-0659	
07	43650-0703		43650-0704		43650-0705		43650-0759	
08	43650-0803		43650-0804		43650-0805		43650-0859	
09	43650-0903		43650-0904		43650-0905		43650-0959	
10	43650-1003		43650-1004		43650-1005		43650-1059	
11	43650-1103		43650-1104		43650-1105		43650-1159	
12	43650-1203		43650-1204		43650-1205		43650-1259	
07	43650-1703	05					43650-1759	05

REVISE FINISH A REC NO: UCP2016-2546 DRAWN BY: DRWINBAPPELDORN 2016/01/28 CHKD: JFOUX 2016/01/28 APPR: SMITH 2016/03/18 E4	QUALITY SYMBOLS □=0 □=0 □=0	GENERAL TOLERANCES (UNLESS SPECIFIED) mm INCH 4 PLACES ±.010 ±.010 3 PLACES ±.025 ±.014 2 PLACES ±0.36 ±.010 1 PLACE ±.010 ±.010 0 PLACE ±.010 ±.010	DIMENSION STYLE IN/MM	SCALE ---	DESIGN UNITS METRIC	THIRD ANGLE PROJECTION
		DRAWN BY: SAMIEC DATE: 2000/07/07 CHECKED BY: MUELLER DATE: 2000/07/07 APPROVED BY: FSMITH DATE: 2016/03/18	MATERIAL NO. SEE CHART	DOCUMENT NO. SD-43650-002	SHEET NO. 1 OF 1	
		MICRO FIT (3.0) SINGLE ROW / RIGHT ANGLE THRU HOLE / CLIPS / TRAY				

THIS DRAWING CONTAINS INFORMATION THAT IS PROPRIETARY TO MOLEX INCORPORATED AND SHOULD NOT BE USED WITHOUT WRITTEN PERMISSION