

Excellent Integrated System Limited

Stocking Distributor

Click to view price, real time Inventory, Delivery & Lifecycle Information:

[Laird Technologies - Signal Integrity Products](#)
[CM3440Z171R-00](#)

For any questions, you can email us directly:

sales@integrated-circuit.com

Steward

Advanced Ferrite Materials, EMI Suppression, and Inductive Products

Home • Ferrite Product Lines • New Products • Technical • General • Contact • Steward Sales

CM3440Z171R-00

STEWARD PART NUMBERING SYSTEM					
CM	2545	X	111	B	- 00
PRODUCT SERIES CODE	PART SIZE CODE	RATED CURRENT CODE	IMPEDANCE VALUE CODE	PACKAGING CODE	ADDITIONAL DESCRIPTION

Ambient Operating Temperature Range : -55°C to + 125°C

Surface Mount

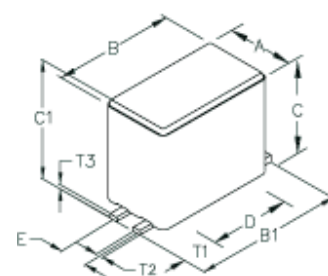

Figure #1

Thru-Hole

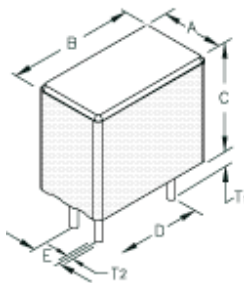

Figure #2

Surface Mount

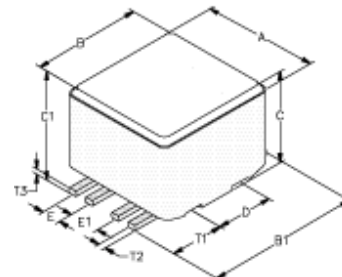

Figure #3

Surface Mount

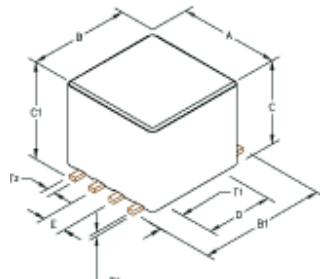

Figure #4

Thru-Hole

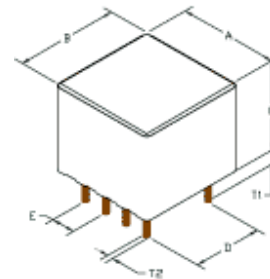
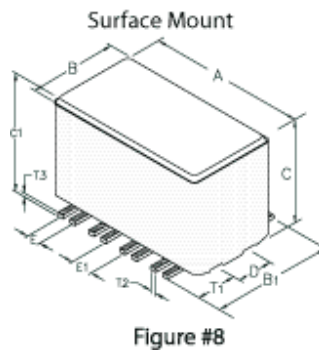
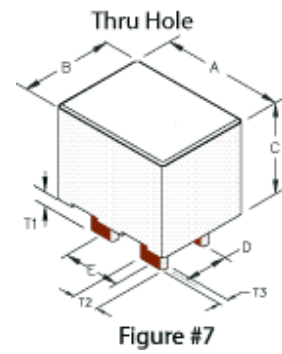
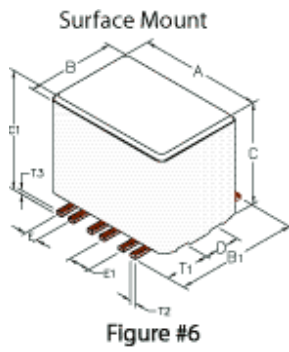

Figure #5



Drawing Figure #

Figure Number
1

Electrical Characteristics

NET Z @ 100 MHz	DCR Max	Rated Current mA
170	0.001	20000

Physical Dimensions

A	B	B1	C	C1	D	E	E1	A	B	B1	C	C1	D	E	E1
mm	mm	mm	mm	mm	mm	mm	mm	in	in	in	in	in	in	in	in
8.51	10.03	11.05	9.32	10.49	4.06	2.54	-	0.335	0.395	0.435	0.367	0.413	0.160	0.100	-

Wire Dimensions

T1 mm	T2 mm	T3 mm	T1 in	T2 in	T3 in
3.56	0.76	0.76	0.140	0.030	0.030

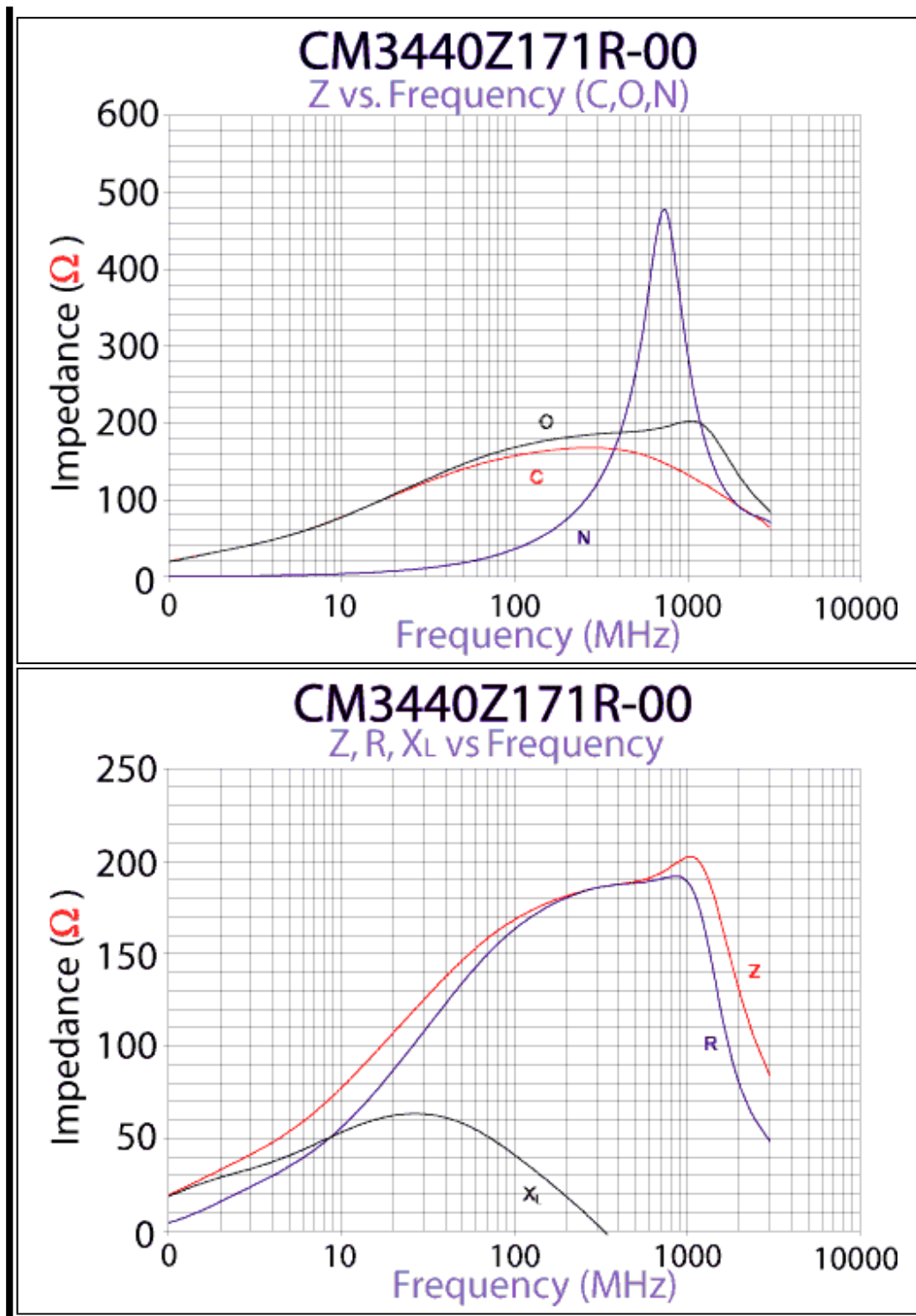

Specifications, which provide more details for the correct use of the described products, are available upon request. All specifications are subject to change without notice. For more information on any of the products listed above, please contact Steward customer service department at (800) 634-2673.

americas@steward.com

mexico@steward.com

europa@steward.com

asia@steward.com

Copyright© 2004 Steward, Inc.

Last Updated: 2/24/2004