

## Excellent Integrated System Limited

Stocking Distributor

Click to view price, real time Inventory, Delivery & Lifecycle Information:

[ON Semiconductor](#)  
[MC14070BDR2](#)

For any questions, you can email us directly:

[sales@integrated-circuit.com](mailto:sales@integrated-circuit.com)

# MC14070B, MC14077B

## CMOS SSI

### Quad Exclusive “OR” and “NOR” Gates

The MC14070B quad exclusive OR gate and the MC14077B quad exclusive NOR gate are constructed with MOS P-channel and N-channel enhancement mode devices in a single monolithic structure. These complementary MOS logic gates find primary use where low power dissipation and/or high noise immunity is desired.

#### Features

- Supply Voltage Range = 3.0 Vdc to 18 Vdc
- All Outputs Buffered
- Capable of Driving Two Low-Power TTL Loads or One Low-Power Schottky TTL Load Over the Rated Temperature Range
- Double Diode Protection on All Inputs
- MC14070B – Replacement for CD4030B and CD4070B Types
- MC14077B – Replacement for CD4077B Type
- NLV Prefix for Automotive and Other Applications Requiring Unique Site and Control Change Requirements; AEC-Q100 Qualified and PPAP Capable
- These Devices are Pb-Free and are RoHS Compliant

#### MAXIMUM RATINGS (Voltages Referenced to V<sub>SS</sub>)

Symbol	Parameter	Value	Unit
V <sub>DD</sub>	DC Supply Voltage Range	-0.5 to +18.0	V
V <sub>in</sub> , V <sub>out</sub>	Input or Output Voltage Range (DC or Transient)	-0.5 to V <sub>DD</sub> + 0.5	V
I <sub>in</sub> , I <sub>out</sub>	Input or Output Current (DC or Transient) per Pin	±10	mA
P <sub>D</sub>	Power Dissipation, per Package (Note 1)	500	mW
T <sub>A</sub>	Ambient Temperature Range	-55 to +125	°C
T <sub>stg</sub>	Storage Temperature Range	-65 to +150	°C
T <sub>L</sub>	Lead Temperature (8-Second Soldering)	260	°C

Stresses exceeding those listed in the Maximum Ratings table may damage the device. If any of these limits are exceeded, device functionality should not be assumed, damage may occur and reliability may be affected.

1. Temperature Derating: “D/DW” Packages: -7.0 mW/°C From 65°C To 125°C

This device contains protection circuitry to guard against damage due to high static voltages or electric fields. However, precautions must be taken to avoid applications of any voltage higher than maximum rated voltages to this high-impedance circuit. For proper operation, V<sub>in</sub> and V<sub>out</sub> should be constrained to the range V<sub>SS</sub> ≤ (V<sub>in</sub> or V<sub>out</sub>) ≤ V<sub>DD</sub>.

Unused inputs must always be tied to an appropriate logic voltage level (e.g., either V<sub>SS</sub> or V<sub>DD</sub>). Unused outputs must be left open.



ON Semiconductor®

<http://onsemi.com>



SOIC-14  
D SUFFIX  
CASE 751A

#### PIN ASSIGNMENT

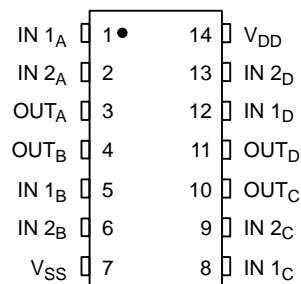

#### MARKING DIAGRAM

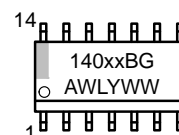

- xx = Specific Device Code
- A = Assembly Location
- WL, L = Wafer Lot
- YY, Y = Year
- WW, W = Work Week
- G = Pb-Free Package

#### ORDERING INFORMATION

See detailed ordering and shipping information in the package dimensions section on page 4 of this data sheet.

**MC14070B, MC14077B**

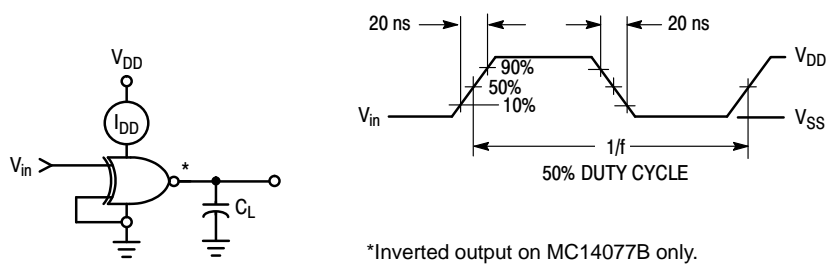
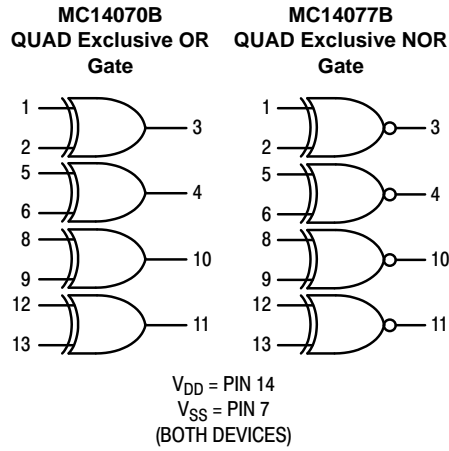

**Figure 1. Power Dissipation Test Circuit and Waveform**

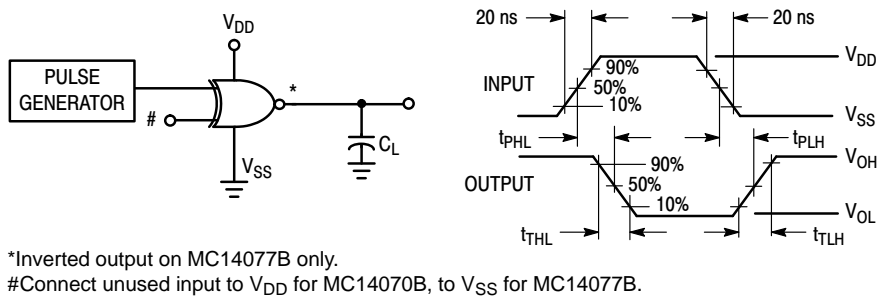

**Figure 2. Switching Time Test Circuit and Waveforms**

## MC14070B, MC14077B

**ELECTRICAL CHARACTERISTICS** (Voltages Referenced to  $V_{SS}$ )

Characteristic	Symbol	$V_{DD}$ Vdc	-55°C		25°C			125°C		Unit
			Min	Max	Min	Typ (Note 2)	Max	Min	Max	
Output Voltage $V_{in} = V_{DD}$ or 0	"0" Level $V_{OL}$	5.0	–	0.05	–	0	0.05	–	0.05	Vdc
		10	–	0.05	–	0	0.05	–	0.05	
15		–	0.05	–	0	0.05	–	0.05		
$V_{in} = 0$ or $V_{DD}$	"1" Level $V_{OH}$	5.0	4.95	–	4.95	5.0	–	4.95	–	Vdc
		10	9.95	–	9.95	10	–	9.95	–	
		15	14.95	–	14.95	15	–	14.95	–	
Input Voltage ( $V_O = 4.5$ or $0.5$ Vdc) ( $V_O = 9.0$ or $1.0$ Vdc) ( $V_O = 13.5$ or $1.5$ Vdc)	"0" Level $V_{IL}$	5.0	–	1.5	–	2.25	1.5	–	1.5	Vdc
		10	–	3.0	–	4.50	3.0	–	3.0	
		15	–	4.0	–	6.75	4.0	–	4.0	
	"1" Level $V_{IH}$	5.0	3.5	–	3.5	2.75	–	3.5	–	Vdc
		10	7.0	–	7.0	5.50	–	7.0	–	
		15	11	–	11	8.25	–	11	–	
Output Drive Current ( $V_{OH} = 2.5$ Vdc) ( $V_{OH} = 4.6$ Vdc) ( $V_{OH} = 9.5$ Vdc) ( $V_{OH} = 13.5$ Vdc)	Source $I_{OH}$	5.0	–3.0	–	–2.4	–4.2	–	–1.7	–	mAdc
		5.0	–0.64	–	–0.51	–0.88	–	–0.36	–	
		10	–1.6	–	–1.3	–2.25	–	–0.9	–	
		15	–4.2	–	–3.4	–8.8	–	–2.4	–	
	Sink $I_{OL}$	5.0	0.64	–	0.51	0.88	–	0.36	–	mAdc
		10	1.6	–	1.3	2.25	–	0.9	–	
15	4.2	–	3.4	8.8	–	2.4	–	–		
Input Current	$I_{in}$	15	–	±0.1	–	±0.00001	±0.1	–	±1.0	μAdc
Input Capacitance ( $V_{in} = 0$ )	$C_{in}$	–	–	–	–	5.0	7.5	–	–	pF
Quiescent Current (Per Package)	$I_{DD}$	5.0	–	0.25	–	0.0005	0.25	–	7.5	μAdc
		10	–	0.5	–	0.0010	0.5	–	15	
		15	–	1.0	–	0.0015	1.0	–	30	
Total Supply Current (Notes 3 & 4) (Dynamic plus Quiescent, Per Package) ( $C_L = 50$ pF on all outputs, all buffers switching)	$I_T$	5.0	$I_T = (0.3 \mu A/kHz) f + I_{DD}$							μAdc
		10	$I_T = (0.6 \mu A/kHz) f + I_{DD}$							
		15	$I_T = (0.9 \mu A/kHz) f + I_{DD}$							
Output Rise and Fall Times (Note 3) ( $C_L = 50$ pF) $t_{TLH}, t_{THL} = (1.35 \text{ ns/pF}) C_L + 33 \text{ ns}$ $t_{TLH}, t_{THL} = (0.60 \text{ ns/pF}) C_L + 20 \text{ ns}$ $t_{TLH}, t_{THL} = (0.40 \text{ ns/pF}) C_L + 20 \text{ ns}$	$t_{TLH},$ $t_{THL}$	5.0	–	–	–	100	200	–	–	ns
		10	–	–	–	50	100	–	–	
		15	–	–	–	40	80	–	–	
		–	–	–	–	–	–	–	–	
Propagation Delay Times (Note 3) ( $C_L = 50$ pF) $t_{PLH}, t_{PHL} = (0.90 \text{ ns/pF}) C_L + 130 \text{ ns}$ $t_{PLH}, t_{PHL} = (0.36 \text{ ns/pF}) C_L + 57 \text{ ns}$ $t_{PLH}, t_{PHL} = (0.26 \text{ ns/pF}) C_L + 37 \text{ ns}$	$t_{PLH},$ $t_{PHL}$	5.0	–	–	–	175	350	–	–	ns
		10	–	–	–	75	150	–	–	
		15	–	–	–	55	110	–	–	
		–	–	–	–	–	–	–	–	

Product parametric performance is indicated in the Electrical Characteristics for the listed test conditions, unless otherwise noted. Product performance may not be indicated by the Electrical Characteristics if operated under different conditions.

2. Data labelled "Typ" is not to be used for design purposes but is intended as an indication of the IC's potential performance.

3. The formulas given are for the typical characteristics only at 25°C.

4. To calculate total supply current at loads other than 50 pF:

$$I_T(C_L) = I_T(50 \text{ pF}) + (C_L - 50) \text{ Vfk}$$

where:  $I_T$  is in μH (per package),  $C_L$  in pF,  $V = (V_{DD} - V_{SS})$  in volts,  $f$  in kHz is input frequency, and  $k = 0.002$ .

## MC14070B, MC14077B

### ORDERING INFORMATION

Device	Package	Shipping†
MC14070BDG	SOIC-14 (Pb-Free)	55 Units / Rail
MC14070BDR2G	SOIC-14 (Pb-Free)	2500 / Tape & Reel
NLV14070BDR2G*	SOIC-14 (Pb-Free)	2500 / Tape & Reel

MC14077BDG	SOIC-14 (Pb-Free)	55 Units / Rail
MC14077BDR2G	SOIC-14 (Pb-Free)	2500 / Tape & Reel
NLV14077BDR2G*	SOIC-14 (Pb-Free)	2500 / Tape & Reel

†For information on tape and reel specifications, including part orientation and tape sizes, please refer to our Tape and Reel Packaging Specifications Brochure, BRD8011/D.

\*NLV Prefix for Automotive and Other Applications Requiring Unique Site and Control Change Requirements; AEC-Q100 Qualified and PPAP Capable.

## MC14070B, MC14077B

### PACKAGE DIMENSIONS

#### SOIC-14 NB CASE 751A-03 ISSUE K

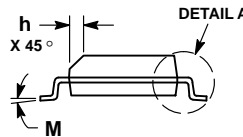
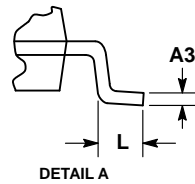
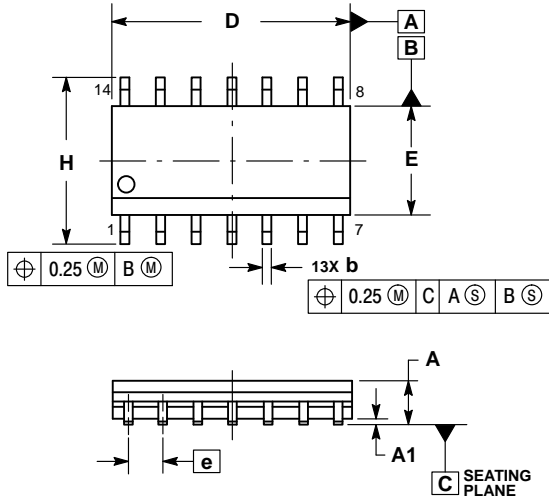

NOTES:

1. DIMENSIONING AND TOLERANCING PER ASME Y14.5M, 1994.
2. CONTROLLING DIMENSION: MILLIMETERS.
3. DIMENSION b DOES NOT INCLUDE DAMBAR PROTRUSION. ALLOWABLE PROTRUSION SHALL BE 0.13 TOTAL IN EXCESS OF AT MAXIMUM MATERIAL CONDITION.
4. DIMENSIONS D AND E DO NOT INCLUDE MOLD PROTRUSIONS.
5. MAXIMUM MOLD PROTRUSION 0.15 PER SIDE.

DIM	MILLIMETERS		INCHES	
	MIN	MAX	MIN	MAX
A	1.35	1.75	0.054	0.068
A1	0.10	0.25	0.004	0.010
A3	0.19	0.25	0.008	0.010
b	0.35	0.49	0.014	0.019
D	8.55	8.75	0.337	0.344
E	3.80	4.00	0.150	0.157
e	1.27 BSC		0.050 BSC	
H	5.80	6.20	0.228	0.244
h	0.25	0.50	0.010	0.019
L	0.40	1.25	0.016	0.049
M	0°	7°	0°	7°

#### SOLDERING FOOTPRINT\*

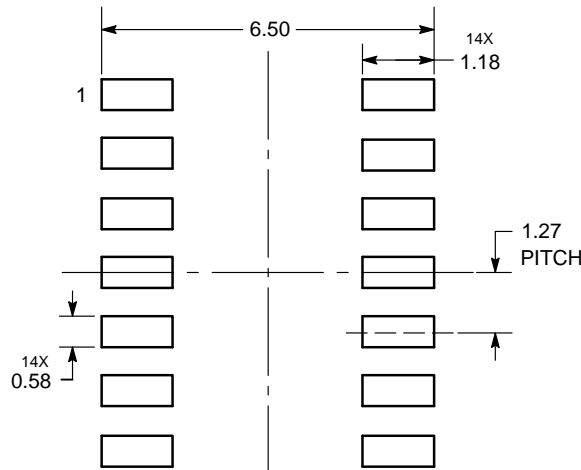

DIMENSIONS: MILLIMETERS

\*For additional information on our Pb-Free strategy and soldering details, please download the ON Semiconductor Soldering and Mounting Techniques Reference Manual, SOLDERRM/D.

ON Semiconductor and the are registered trademarks of Semiconductor Components Industries, LLC (SCILLC) or its subsidiaries in the United States and/or other countries. SCILLC owns the rights to a number of patents, trademarks, copyrights, trade secrets, and other intellectual property. A listing of SCILLC's product/patent coverage may be accessed at [www.onsemi.com/site/pdf/Patent-Marking.pdf](http://www.onsemi.com/site/pdf/Patent-Marking.pdf). SCILLC reserves the right to make changes without further notice to any products herein. SCILLC makes no warranty, representation or guarantee regarding the suitability of its products for any particular purpose, nor does SCILLC assume any liability arising out of the application or use of any product or circuit, and specifically disclaims any and all liability, including without limitation special, consequential or incidental damages. "Typical" parameters which may be provided in SCILLC data sheets and/or specifications can and do vary in different applications and actual performance may vary over time. All operating parameters, including "Typicals" must be validated for each customer application by customer's technical experts. SCILLC does not convey any license under its patent rights nor the rights of others. SCILLC products are not designed, intended, or authorized for use as components in systems intended for surgical implant into the body, or other applications intended to support or sustain life, or for any other application in which the failure of the SCILLC product could create a situation where personal injury or death may occur. Should Buyer purchase or use SCILLC products for any such unintended or unauthorized application, Buyer shall indemnify and hold SCILLC and its officers, employees, subsidiaries, affiliates, and distributors harmless against all claims, costs, damages, and expenses, and reasonable attorney fees arising out of, directly or indirectly, any claim of personal injury or death associated with such unintended or unauthorized use, even if such claim alleges that SCILLC was negligent regarding the design or manufacture of the part. SCILLC is an Equal Opportunity/Affirmative Action Employer. This literature is subject to all applicable copyright laws and is not for resale in any manner.

#### PUBLICATION ORDERING INFORMATION

##### LITERATURE FULFILLMENT:

Literature Distribution Center for ON Semiconductor  
 P.O. Box 5163, Denver, Colorado 80217 USA  
 Phone: 303-675-2175 or 800-344-3860 Toll Free USA/Canada  
 Fax: 303-675-2176 or 800-344-3867 Toll Free USA/Canada  
 Email: [orderlit@onsemi.com](mailto:orderlit@onsemi.com)

N. American Technical Support: 800-282-9855 Toll Free  
 USA/Canada

Europe, Middle East and Africa Technical Support:  
 Phone: 421 33 790 2910

Japan Customer Focus Center  
 Phone: 81-3-5817-1050

ON Semiconductor Website: [www.onsemi.com](http://www.onsemi.com)

Order Literature: <http://www.onsemi.com/orderlit>

For additional information, please contact your local Sales Representative