

Excellent Integrated System Limited

Stocking Distributor

Click to view price, real time Inventory, Delivery & Lifecycle Information:

[STMicroelectronics](#)

[STPS0520Z](#)

For any questions, you can email us directly:

sales@integrated-circuit.com



STPS0520Z

SCHOTTKY RECTIFIERS

MAIN PRODUCT CHARACTERISTICS

I_{F(AV)}	0.5 A
V_{RRM}	20 V
V_{F (max)}	0.32 V

FEATURES AND BENEFITS

- VERY SMALL CONDUCTION LOSSES
- NEGLIGIBLE SWITCHING LOSSES
- EXTREMELY FAST SWITCHING

DESCRIPTION

Single Schottky rectifier suited for switch mode power supplies and high frequency DC to DC converters.

Packaged in SOD-123, this device is intended for use in low voltage, high frequency inverters, free wheeling and polarity protection applications. Due to the small size of the package this device fits GSM and PCMCIA requirements.

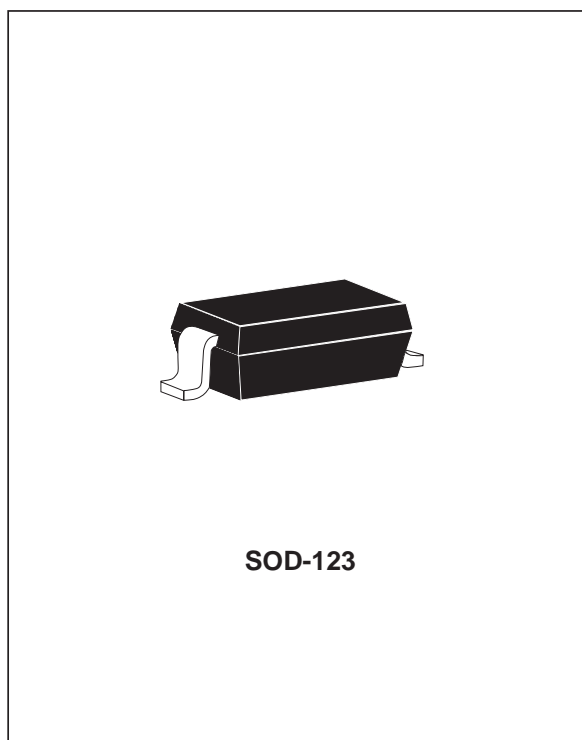

ABSOLUTE RATINGS (limiting values)

Symbol	Parameter	Value	Unit
V _{RRM}	Repetitive peak reverse voltage	20	V
I _{F(RMS)}	RMS forward current	2	A
I _{F(AV)}	Average forward current δ=0.5	Ta=25°C 0.5	A
I _{FSM}	Surge non repetitive forward current	tp=10ms sinusoidal 5.5	A
dV/dt	Critical rate of rise of reverse voltage	10000	V/μs
T _{stg}	Storage temperature range	- 65 to + 125	°C
T _j	Maximum operating junction temperature *	125	°C
TL	Maximum temperature for soldering during 10s	260	°C

* : $\frac{dP_{tot}}{dT_j} < \frac{1}{R_{th}(j-a)}$ thermal runaway condition for a diode on its own heatsink

STPS0520Z

THERMAL RESISTANCE

Symbol	Parameter	Value	Unit
$R_{th(j-a)}$	Junction to ambient	430 (*) 210 (**)	°C/W

(*) Mounted on epoxy board with recommended Pad Layout.

(**) Mounted on epoxy board with 50mm² copper area.

STATIC ELECTRICAL CHARACTERISTICS

Symbol	Parameter	Tests conditions		Value		Unit
				STPS0520Z		
				typ.	max.	
I_R^*	Reverse leakage current	$T_j = 25^\circ\text{C}$	$V_R = 10\text{ V}$		60	μA
				$T_j = 100^\circ\text{C}$	2.5	5
		$T_j = 25^\circ\text{C}$	$V_R = V_{RRM}$		150	μA
				$T_j = 100^\circ\text{C}$	4.3	8
V_F^{**}	Forward voltage drop	$T_j = 25^\circ\text{C}$	$I_F = 0.1\text{ A}$		0.3	V
				$T_j = 100^\circ\text{C}$	0.18	
		$T_j = 25^\circ\text{C}$	$I_F = 0.5\text{ A}$		0.385	
				$T_j = 100^\circ\text{C}$	0.29	

Pulse test : * $t_p = 5\text{ ms}$, $\delta < 2\%$

** $t_p = 380\ \mu\text{s}$, $\delta < 2\%$

To evaluate the maximum conduction losses use the following equation :

$$P = 0.23 \times I_{F(AV)} + 0.18 \times I_{F(RMS)}^2$$

STPS0520Z

Fig. 1: Average forward power dissipation versus average forward current

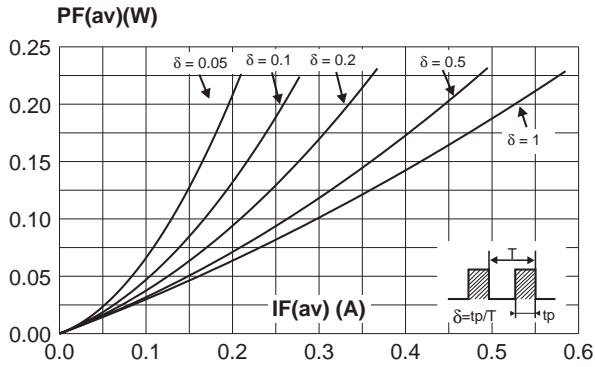

Fig. 2: Average forward current versus ambient temperature ($\delta = 0.5$)

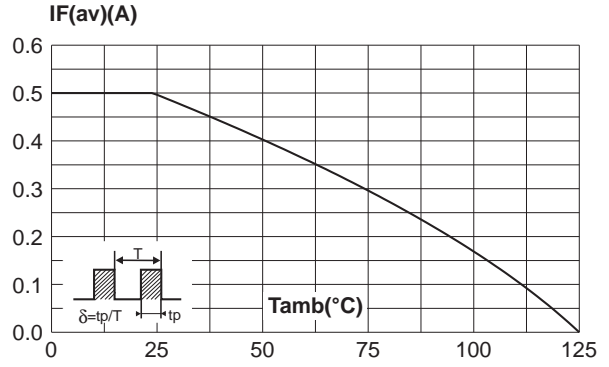

Fig. 3: Non repetitive surge peak forward current versus overload duration (maximum values).

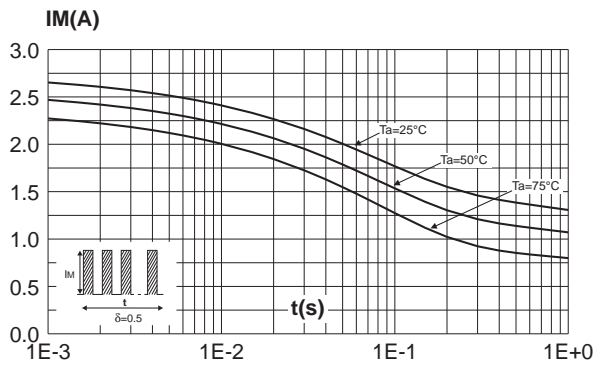

Fig. 4: Relative variation of thermal impedance junction to ambient versus pulse duration (Epoxy printed circuit board FR4 with recommended pad layout).

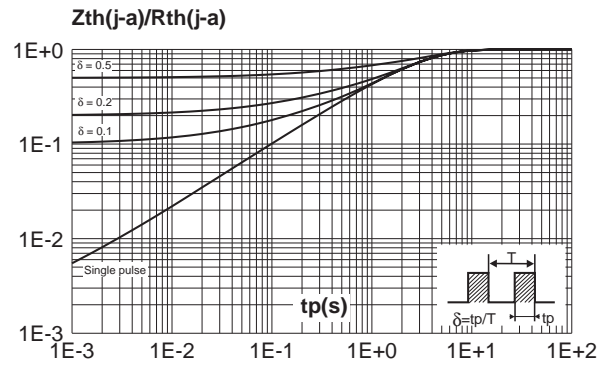

Fig. 5: Reverse leakage current versus reverse voltage applied (typical values).

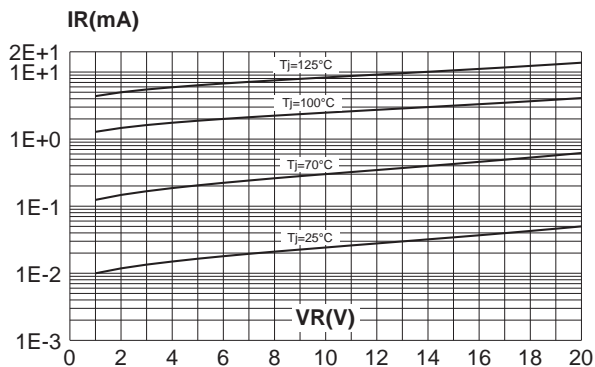
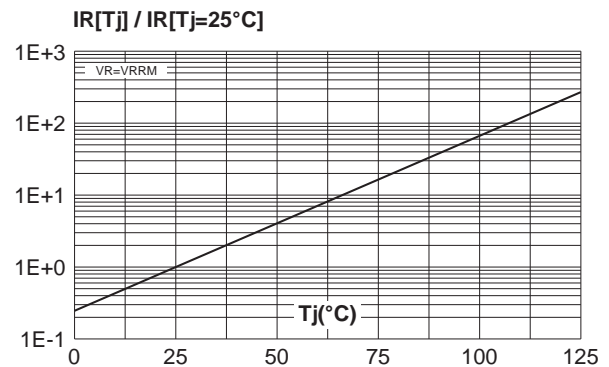

Fig. 6: Relative variation of reverse leakage current versus junction temperature (typical values).



STPS0520Z

Fig. 7: Junction capacitance versus reverse voltage applied (typical values).

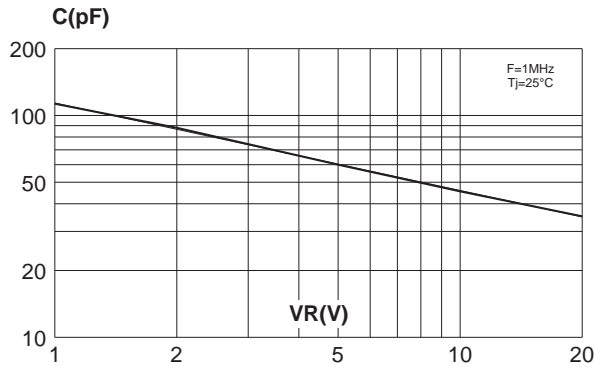

Fig. 8-1: Forward voltage drop versus forward current (maximum values, low level)

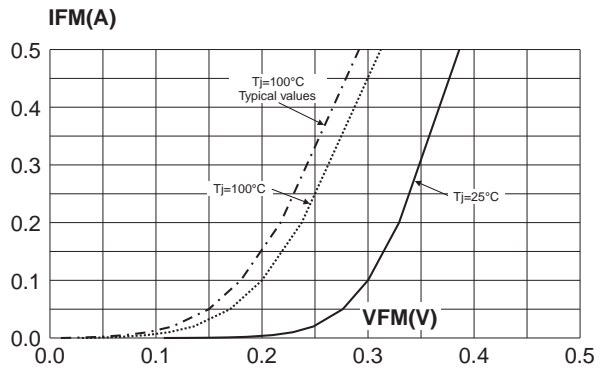

Fig. 8-2: Forward voltage drop versus forward current (maximum values, high level)

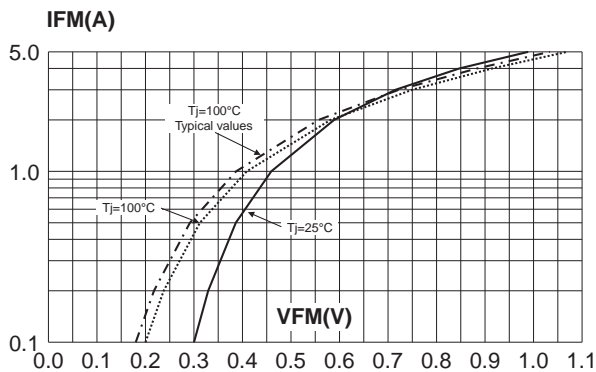
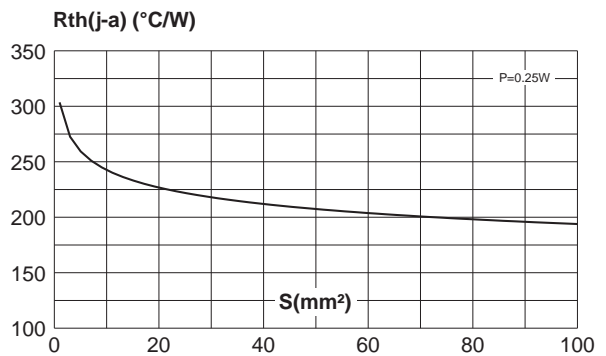
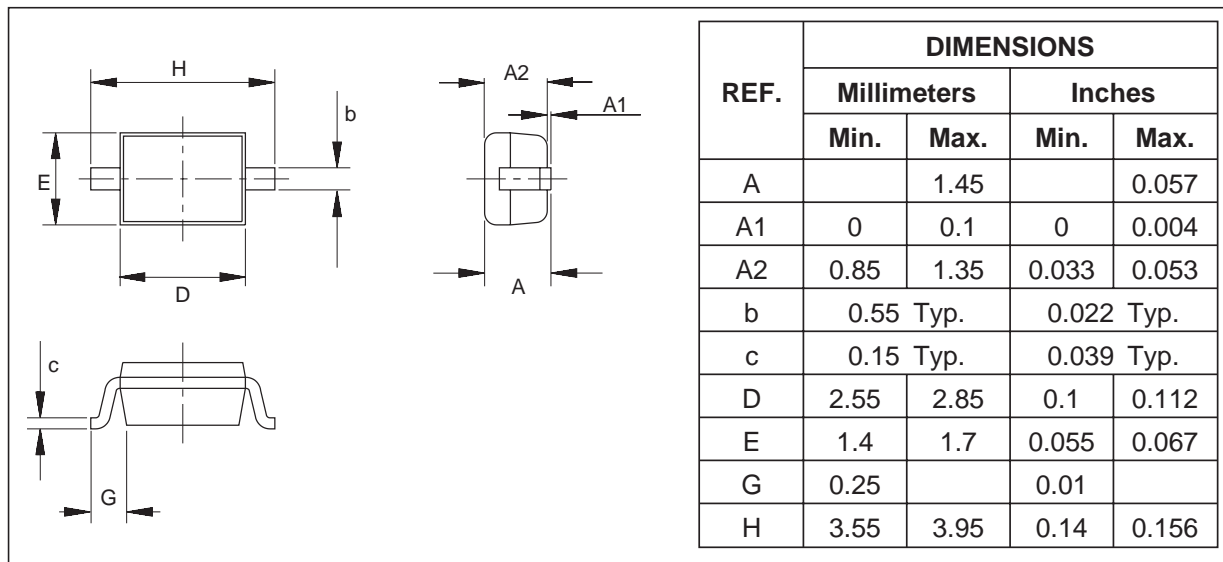

Fig. 9: Variation of thermal resistance junction to ambient versus copper surface under each lead (Printed circuit board FR4, e(Cu) = 35µm).



STPS0520Z

PACKAGE MECHANICAL DATA SOD-123



FOOTPRINT (in millimeters)

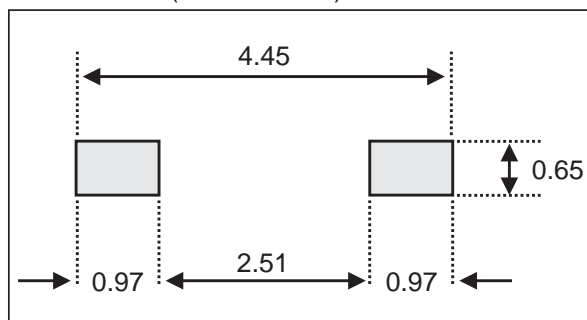

MARKING

Type	Marking	Package	Weight	Base qty	Delivery mode
STPS0520Z	Z52	SOD-123	0.01g.	3000	Tape & reel
STPS0520Z10K	Z52	SOD-123	0.01 g	10000	Tape & reel

- Epoxy meets UL94, V0.
- Band indicates cathode.

Information furnished is believed to be accurate and reliable. However, STMicroelectronics assumes no responsibility for the consequences of use of such information nor for any infringement of patents or other rights of third parties which may result from its use. No license is granted by implication or otherwise under any patent or patent rights of STMicroelectronics. Specifications mentioned in this publication are subject to change without notice. This publication supersedes and replaces all information previously supplied. STMicroelectronics products are not authorized for use as critical components in life support devices or systems without express written approval of STMicroelectronics.

The ST logo is a registered trademark of STMicroelectronics

© 2002 STMicroelectronics - Printed in Italy - All rights reserved.

STMicroelectronics GROUP OF COMPANIES

Australia - Brazil - Canada - China - Finland - France - Germany
 Hong Kong - India - Israel - Italy - Japan - Malaysia - Malta - Morocco - Singapore
 Spain - Sweden - Switzerland - United Kingdom - United States.

<http://www.st.com>