

Excellent Integrated System Limited

Stocking Distributor

Click to view price, real time Inventory, Delivery & Lifecycle Information:

[E-Switch](#)
[R1966AWHTWHITESRED](#)

For any questions, you can email us directly:

sales@integrated-circuit.com

SHEET OF

PANEL THICKNESS	X dimension
0.75-1.25 [.030-.049]	19.2-01 [.756]
1.25-2.0 [.049-.079]	19.4-01 [.764]
2.0-3.0 [.079-.118]	19.8-01 [.780]

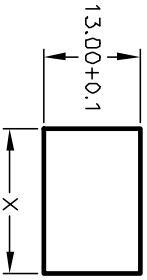

PANEL CUTOUT
NOT TO SCALE

SWITCH FUNCTION	
PDS. 1	PDS. 2
DN	UP
1-1a	OPEN

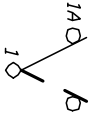

CIRCUIT: SPST

NOTES:

1. ALL DIMENSIONS IN MM [INCH]
2. GENERAL TOLERANCE: X.X=±0.4
X.XX=±0.25
3. TERMINAL NUMBERS FOR REF ONLY
4. RATING: 15A @ 125VAC OR 6A @ 250VAC
5. MATERIALS: (TERMINALS) SILVER PLATED COPPER
(CONTACTS) COIN SILVER, SILVER PLATED.
6. CONTACT RESISTANCE: <20 Mega
7. ELECTRICAL LIFE: 10,000 cycles
8. INSULATION RESISTANCE: >1000 Mega
9. DIELECTRIC STRENGTH: >1500V 1 minute
>3000V between Poles
10. OPERATING TEMP.: -25°C to +85°C

RED L.E.D

PARAMETERS	SYMBOL	MAX.	TYP.	UNITS
POWER DISSIPATION	P_D	80		mW
Avg FORWARD CURRENT	I_{AF}	--		mA
PEAK FORWARD CURRENT	I_{PF}	100		mA
REVERSE VOLTAGE	V_R	5		V
FORWARD VOLTAGE	V_F	2.1	1.7	V
REVERSE CURRENT	I_R			µA
EMISSION WAVELENGTH	λ_p			nm
LUMINOUS INTENSITY	I_v			mcd

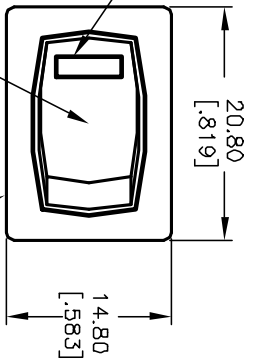

WHITE ACTUATOR
WHITE HOUSING/BODY

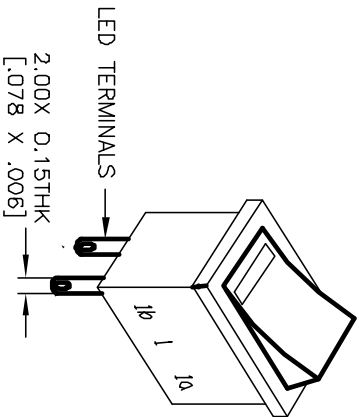
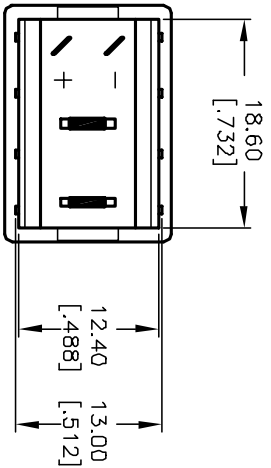
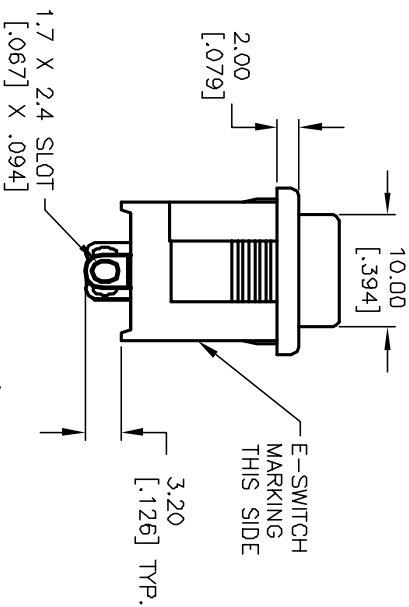
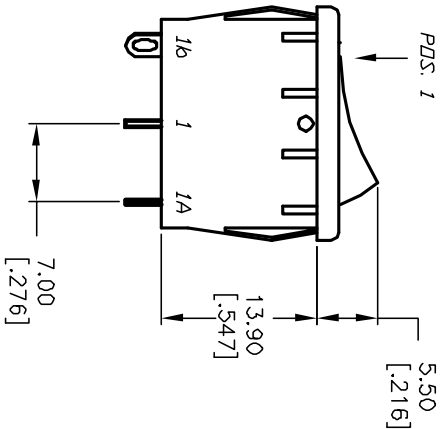

E-SWITCH®

REV.	ECN No.	DESCRIPTION	DATE	CHKD	CJB
A	12578	RELEASED	11/19/02		

TITLE	SCALE	DATE	DR	DWG	REV
R1966A WHT WHT E S RED	1.5:1	11/19/02	MM	M301151	A

THE INFORMATION CONTAINED IN THIS DOCUMENT IS PROPRIETARY TO E-SWITCH AND IS NOT TO BE COPIED OR TRANSMITTED