

Excellent Integrated System Limited

Stocking Distributor

Click to view price, real time Inventory, Delivery & Lifecycle Information:

[Rohm Semiconductor](#)
[BH3856FS-E2](#)

For any questions, you can email us directly:

sales@integrated-circuit.com

BH3856S / BH3856FS

Audio ICs

2-wire serial sound control IC

BH3856S / BH3856FS

The BH3856S and BH3856FS are signal processing ICs designed for volume and tone control in televisions, mini component stereo systems, and other audio products. Their two-line serial control (I²C BUS) enables them to control volume and tone on the basis of signals from a microcomputer, etc.

●Applications

Televisions, [Video equipped television], personal computer televisions, mini component stereo systems, car stereos.

●Features

- 1) I²C BUS facilitates direct serial control from a microcomputer of volume (main volume), balance (left / right), and tone (bass, treble). DC control is also possible.
- 2) Volume is produced by a low-distortion, low-noise VCA. Designed to minimize step noise.
- 3) Stable standard voltage supply and built-in I/O buffer mean that few attachments are needed. SSOP-A32 package designed to save space.
- 4) Matrix surround yields powerful sound.

●Absolute maximum ratings (Ta = 25°C)

Parameter	Symbol	Limits	Unit
Power supply voltage	Vcc	10.0	V
Power dissipation	BH3856S	1200*1	mW
	BH3856FS	850 *2	
Operating temperature	Topr	-40~+85	°C
Storage temperature	Tstg	-55~+150	°C

*1 Reduced by 12mW for each increase in Ta of 1°C over 25°C.

*2 Reduced by 6.8mW for each increase in Ta of 1°C over 25°C.

●Recommended operating conditions (Ta = 25°C)

Parameter	Symbol	Min.	Typ.	Max.	Unit
Power supply voltage	Vcc	6.0	9	9.5	V

Note : I²C BUS is a registered trademark of Philips.

BH3856S / BH3856FS

Audio ICs

● **Block diagram**

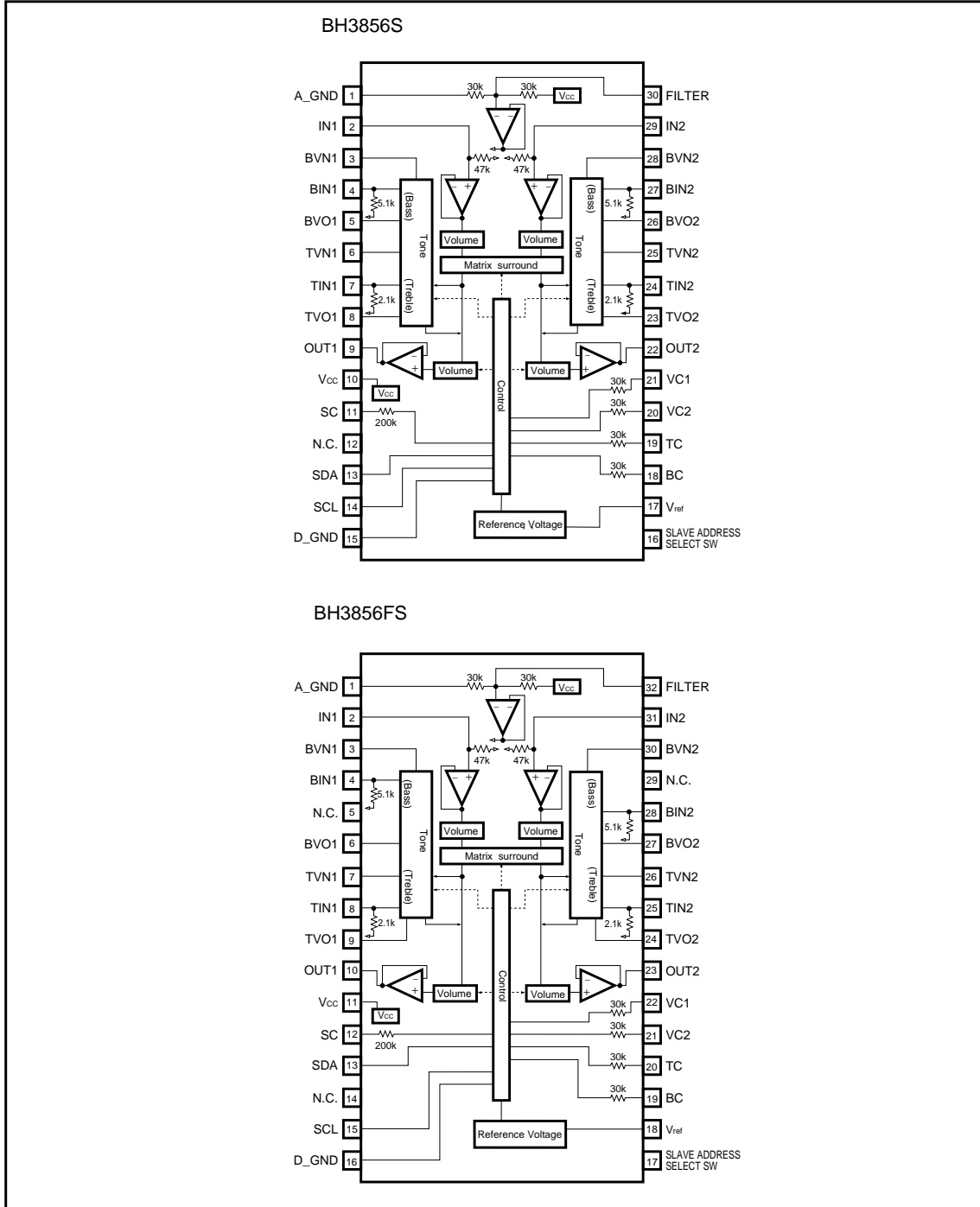

BH3856S / BH3856FS

Audio ICs

●Pin descriptions

Pin No.		Pin name	Function
BH3856S	BH3856FS		
1	1	A_GND	Analog ground
2	2	IN1	Channel 1 volume input
3	3	BVN1	Channel 1 bass filter
4	4	BIN1	Channel 1 bass filter
5	6	BVO1	Channel 1 bass filter
6	7	TVN1	Channel 1 treble filter
7	8	TIN1	Channel 1 treble filter
8	9	TVO1	Channel 1 treble filter
9	10	OUT1	Channel 1 volume output
10	11	V _{CC}	Power supply
11	12	SC	Time constant pin for prevention of switching shock
13	13	SDA	SDA data input pin
14	15	SCL	SCL data input pin
15	16	D_GND	Digital ground
16	17	SASS	Slave address selection pin
17	18	V _{ref}	Reference voltage output
18	19	BC	Time constant pin for prevention of switching shock
19	20	TC	Time constant pin for prevention of switching shock
20	21	VC2	Time constant pin for prevention of switching shock
21	22	VC1	Time constant pin for prevention of switching shock
22	23	OUT2	Channel 2 volume output
23	24	TVO2	Channel 2 treble filter
24	25	TIN2	Channel 2 treble filter
25	26	TVN2	Channel 2 treble filter
26	27	BVO2	Channel 2 bass filter
27	28	BIN2	Channel 2 bass filter
28	30	BVN2	Channel 2 bass filter
29	31	IN2	Channel 2 volume input
30	32	FILTER	Filter
12	5, 14, 29	N.C.	Not connected internally.

BH3856S / BH3856FS

Audio ICs

●Input / output circuits

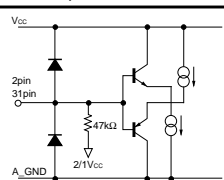
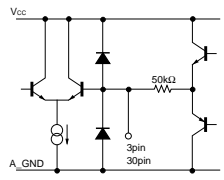
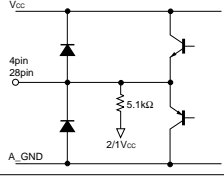
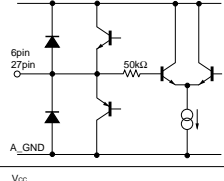
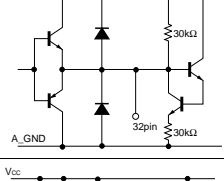
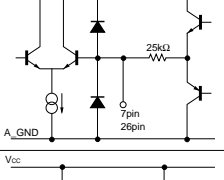
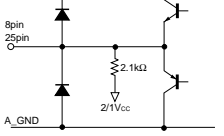
Symbol	Pin voltage	Equivalent circuit	Description
IN1 IN2	4.5V 4.5V		Main volume input pin. Designed for input impedance of 47kΩ(Typ.).
BVN1 BVN2	4.5V 4.5V		Pin for low band filter connection.
BIN1 BIN2	4.5V 4.5V		Pin for low band filter connection.
BVO1 BVO1	4.5V 4.5V		Pin for low band filter connection.
FILTER	5.2V		Filter input pin. Please install a capacitor of about 10μF to the filter pin. Has built-in precharge and discharge circuits.
TVN1 TVN2	4.5V 4.5V		Pin for high band filter connection.
TIN1 TIN2	4.5V 4.5V		Pin for high band filter connection.

*The pin numbers are for the BH3856S.

BH3856S / BH3856FS

Audio ICs

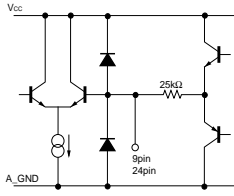
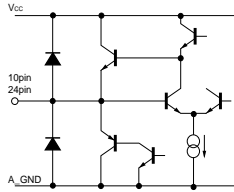
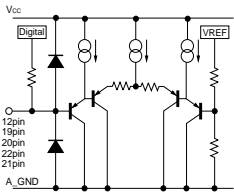
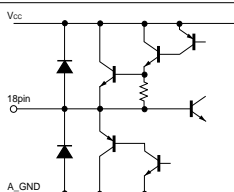
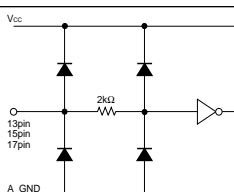
Symbol	Pin voltage	Equivalent Circuit	Description
TVO1 TVO2	4.5V 4.5V		Pin for high band filter connection.
OUT1 OUT2	4.5V 4.5V		Main volume output pin. OUT1 is the volume output for Channel 1. OUT2 is the volume output for Channel 2.
SC BC TC VC1 VC2	—		For prevention of shock noise during step switching. SC : Surround pin BC : Bass pin TC : Treble pin VC1 : Volume pin (Channel 1) VC2 : Volume pin (Channel 2)
Vref	3.8V		3.8V regulator output pin. Output requires capacitor for stopping oscillation. Output pin has built-in precharge and discharge circuits, so there is no problem with start-up or shut-down even with a large capacitor. This pin is for connection to the high-band filter.
SDA SCL SASS	—		· I ² C bus input pin SDA : serial data line SCL : serial clock line · Slave address selection pin SASS: slave address selection switch
Vcc	—	Power supply voltage pin.	
A_GND	—	Analog GND pin. Connected to IC board.	
D_GND	—	Digital GND pin. Separate from Analog GND pin.	

*The pin numbers are for the BH3856S.

BH3856S / BH3856FS

Audio ICs

● **Electrical characteristics** (unless otherwise noted, Ta = 25°C, Vcc = 9V, f = 1kHz, BW = 20 ~ 20kHz, VOL = Max., TONE = ALL FLAT, Rg = 600Ω, RL = 10kΩ)

Parameter	Symbol	Min.	Typ.	Max.	Unit	Conditions
Quiescent current	I _Q	–	20	27	mA	No signal
Maximum input	V _{im}	2.3	2.5	–	V _{rms}	THD=1%, VOL=–20dB (ATT)
Maximum output	V _{om}	2.3	2.5	–	V _{rms}	THD=1%
Voltage gain	G _v	–1.5	0	+1.5	dB	V _{IN} =1V _{rms}
Maximum attenuation	ATT	90	110	–	dB	V _o =1V _{rms}
Crosstalk	V _{CT}	70	80	–	dB	V _o =1V _{rms}
Low range control width	VB Max.	+12	+15	+18	dB	100Hz, V _{IN} =100mV _{rms}
	VB Min.	–18	–15	–12	dB	100Hz, V _{IN} =100mV _{rms}
High range control width	VT Max.	+12	+15	+18	dB	100kHz, V _{IN} =100mV _{rms}
	VT Min.	–18	–15	–12	dB	100kHz, V _{IN} =100mV _{rms}
Matrix surround single-channel gain	G _{SR}	4	6	8	dB	V _o =1V _{rms} *
Total Harmonic distortion	THD	–	0.01	0.1	%	V _o =0.5V _{rms} , BPF=400Hz~30kHz
Output noise voltage	V _{No1}	–	45	65	μV _{rms}	No signal, VOL=Max., R _g =0 *
Residual output noise voltage	V _{MNO}	–	2	10	μV _{rms}	No signal, VOL=–∞, R _g =0 *
Reference power supply output voltage	V _{ref}	3.5	3.8	4.1	V	I _{ref} =3mA
Reference power supply output current capacity	I _{ref}	3.0	10	–	mA	V _{ref} > 3.7V
Channel balance	G _{CB}	–1.5	0	+1.5	dB	channel 1 taken as the standard for measurements.
Input impedance	R _{IN}	33	47	61	kΩ	f=1kHz
Output impedance	R _{OUT}	–	–	10	Ω	f=1kHz
Ripple rejection ratio	RR	40	–	–	dB	f=100Hz, V _{RR} =1V _{rms}
Input high level voltage	V _{IH}	4	–	–	V	SCL, SDA
Input low level voltage	V _{IL}	–	–	1	V	SCL, SDA

* Measurement performed using Matsushita Communication Industrial VP-9690A DIN AUDIO filter (average value wave detection, effective value display).

© Not designed for radiation resistance.

© Signal input occurs in equiphase.

BH3856S / BH3856FS

Audio ICs

● Measurement circuit

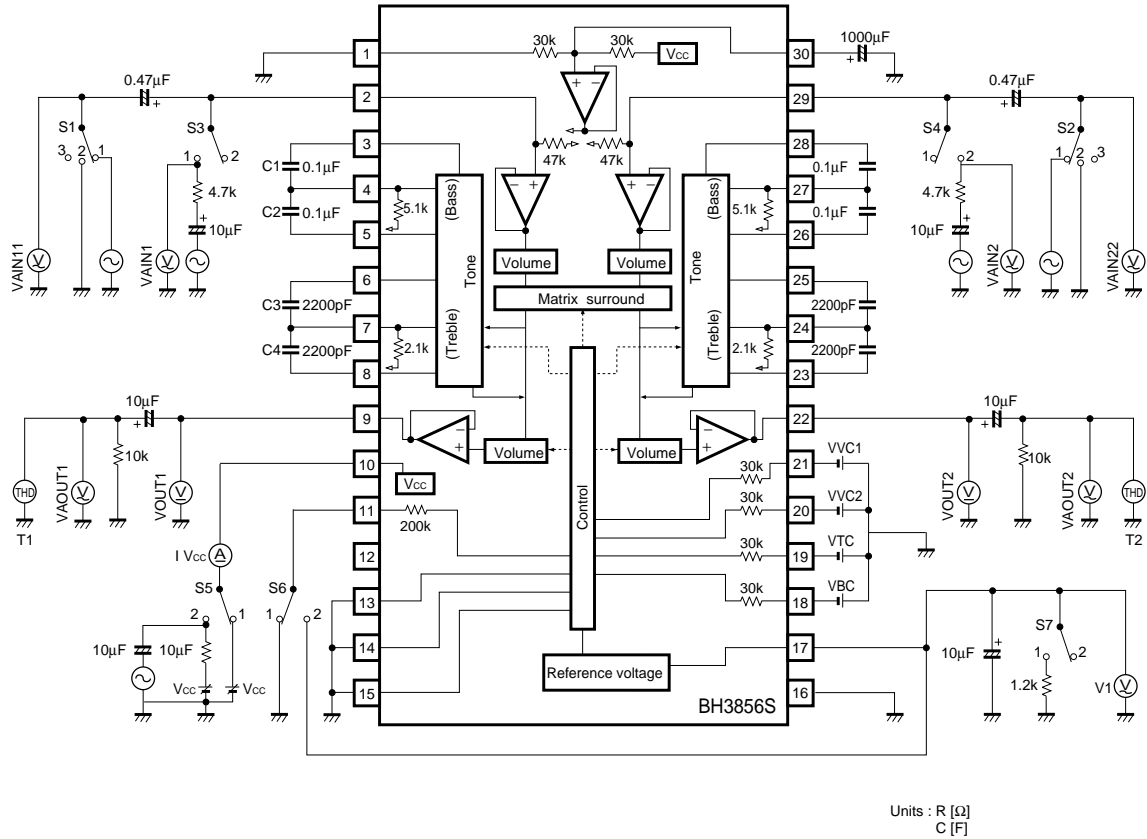

Note : Diagram depicts the BH3856S.

BH3856S / BH3856FS

Audio ICs

●Performing data settings

(1) I²C BUS timing

Parameter	Symbol	Min.	Typ.	Max.	Unit
SCL clock frequency	f _{SCL}	0	–	100	kHz
SCL clock hold time, HIGH state	t _{HIGH}	4	–	–	μs
SCL clock hold time, LOW state	t _{LOW}	4.7	–	–	μs
SDA and SDL signal start-up time	t _r	–	–	1	μs
SDA and SDL signal shut-down time	t _f	–	–	0.3	μs
Set-up time for re-send [start] conditions	t _{SU;STA}	4.7	–	–	μs
Hold time (re-send) [start] conditions (After hold time ends, initial clock pulse is generated.)	t _{HD;STA}	4	–	–	μs
Set time for [stop] conditions.	t _{SU;STO}	4.7	–	–	μs
Bus free time between [stop] condition and [start] condition	t _{BUF}	4.7	–	–	μs
Data set-up time	t _{SU;DAT}	250	–	–	ns

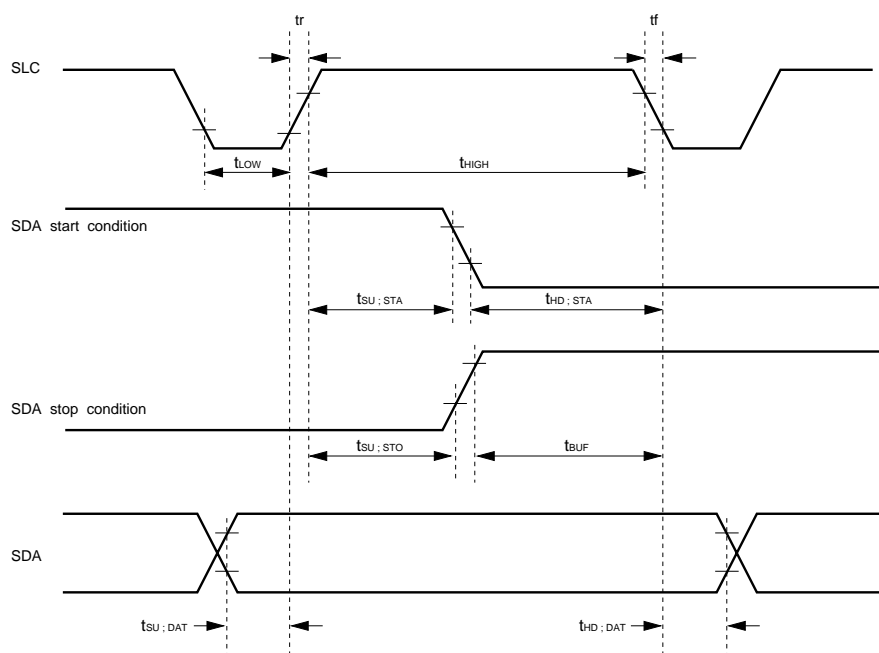

t_{SU;STA} = start code set-up time.
 t_{HD;STA} = start code hold time.
 t_{SU;STO} = stop code set-up time.

t_{BUF} = bus free time.
 t_{SU;DAT} = data set-up time.
 t_{HD;DAT} = data hold time.

I²C BUS timing rules

BH3856S / BH3856FS

Audio ICs

(2) I²C BUS data format

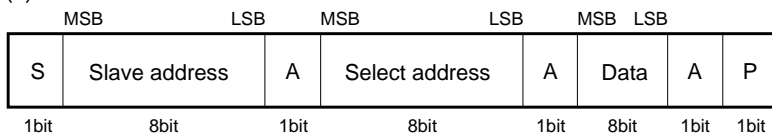

- S = start condition (start bit recognition)
- Slave address = IC recognition. Upper 7 bits are random. Bottom bit is "L" for the sake of overwrite.
- A = acknowledge bit (recognition of acknowledgment)
- Select address = selection between volume, bass, treble and matrix surround.
- Data = volume and tone data
- P = stop condition (stop bit recognition)

(3) BH3856S / BH3856FS slave address

	MSB								LSB
A6	A5	A4	A3	A2	A1	A0	R/W		
1	0	0	0	0	0	A	0		

- Slave address selection
 - 1) A = 1 (10000010) [SASS pin HIGH]
 - 2) A = 0 (10000000) [SASS pin LOW]

(4) Interface protocol

1) Basic protocol

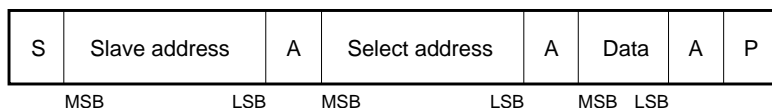

2) Auto increment (Select address increases (+1) by the value of the data.)



- (Example 1) The address data specified by select address is taken as data 1.
- (Example 2) The address data specified by select address +1 is taken as data 2.
- (Example 3) The address data specified by select address +N-1 is taken as data N.

3) Structure with which transmission is not possible (In this case, only select address 1 is set.)

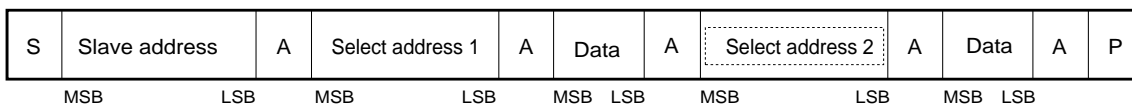

Note : Following transmission of data, data transmitted as select address 2 will not be recognized as select address 2, but as data.

BH3856S / BH3856FS

Audio ICs

(8) Volume attenuation (reference values)

ATT (dB)	DATA (HEX)	ATT (dB)	DATA (HEX)	ATT (dB)	DATA (HEX)
0	FF	-19	85	-56	42
-1	E4	-20	82	-58	3F
-2	D8	-22	7C	-60	3C
-3	CF	-24	78	-62	39
-4	C8	-26	74	-64	36
-5	C2	-28	70	-66	34
-6	BD	-30	6D	-68	32
-7	B8	-32	6A	-70	2F
-8	B2	-34	68	-72	2D
-9	AD	-36	65	-74	2A
-10	A9	-38	61	-76	28
-11	A5	-40	5C	-78	26
-12	A0	-42	59	-80	24
-13	9C	-44	55	-82	22
-14	98	-46	52	-84	20
-15	94	-48	4E	-86	1E
-16	90	-50	4B	-90	1A
-17	8C	-52	48	-100	13
-18	89	-54	45	-112	00

Note : All figures in this table are reference values. When using this IC, check this table carefully and perform the appropriate setting.

(9) Bass / Treble gain settings (reference values)

ATT (dB)	DATA (HEX)	ATT (dB)	DATA (HEX)
15	3F	0	1F
14	38	-1	1C
13	35	-2	1B
12	33	-3	19
11	31	-4	18
10	2F	-5	17
9	2E	-6	16
8	2D	-7	15
7	2C	-8	13
6	2B	-9	12
5	2A	-10	11
4	29	-11	0F
3	27	-12	0D
2	26	-13	0B
1	25	-14	08
0	1F	-15	05

Notes : (1) The gain values in the treble and bass data setting tables above are based on the assumption that the filter constants have been set so that maximum and minimum gain are equal to the peak and bottom values listed in the frequency characteristics drawings.

(2) All figures in this table are reference values. When using this IC, check this table carefully and perform the appropriate setting.

BH3856S / BH3856FS

Audio ICs

● **Application example**

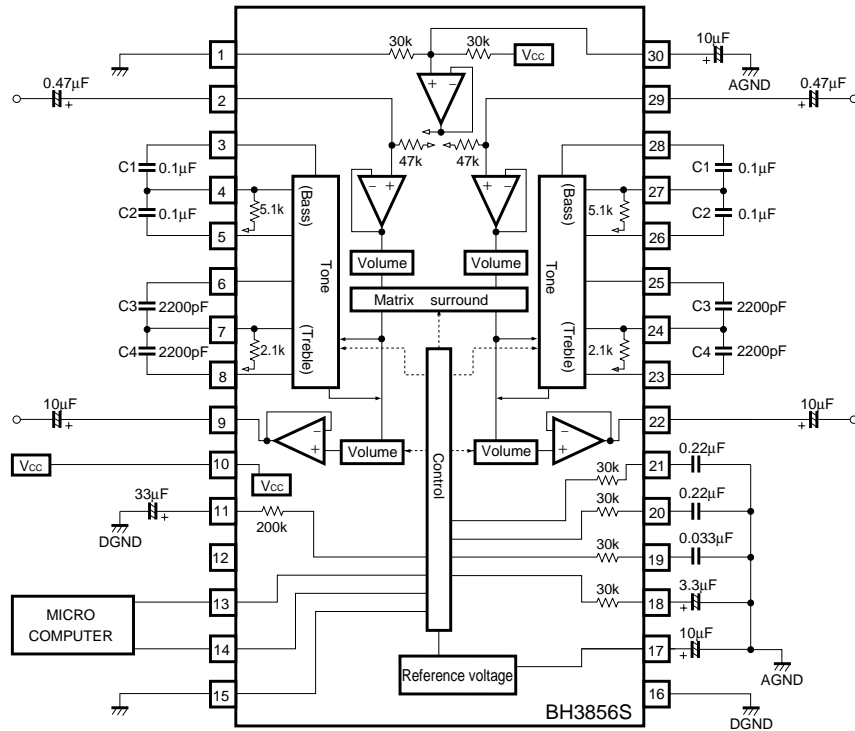

Fig.2

Note : Diagram depicts the BH3856S.

BH3856S / BH3856FS

Audio ICs

●Operation notes

(1) Operating power supply voltage range

As long as the operating power supply voltage and ambient temperature are kept within the specified range, the basic circuits are guaranteed to function, but be sure to check the constants as well as the element settings, voltage settings, and temperature settings.

(2) Bass filter

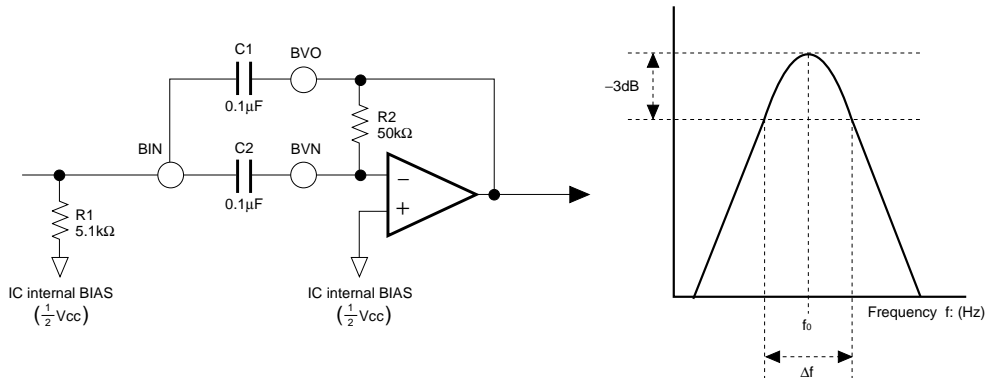

*B.P.F. composed of multiple feedback active f_0 can be varied according to the value of C.BIN (theoretical equation)

$$f_0 = \frac{1}{2\pi} \times \left(\frac{1}{R_1 R_2 C_1 C_2} \right)^{\frac{1}{2}} \quad Q \doteq \left(\left(\frac{1}{R_2 C_1 C_2} \right)^{\frac{1}{2}} \times (C_1 + C_2) \right)^{-1}$$

$$G = \frac{R_2}{5k\Omega} \times \left(1 + \frac{C_1}{C_2} \right)^{-1}$$

Note : Filter gain is calculated using the equation on the left. Total output gain is the sum of the gain for each of the internal circuits.

(When $R_1 = 5.1k\Omega$, $R_2 = 50k\Omega$, $C_1 = C_2 = C$)

$$f_0 = \frac{1.0 \times 10^{-5}}{C} \quad Q \doteq 1.57 \quad G = 5.0$$

BH3856S / BH3856FS

Audio ICs

(3) About the treble filter

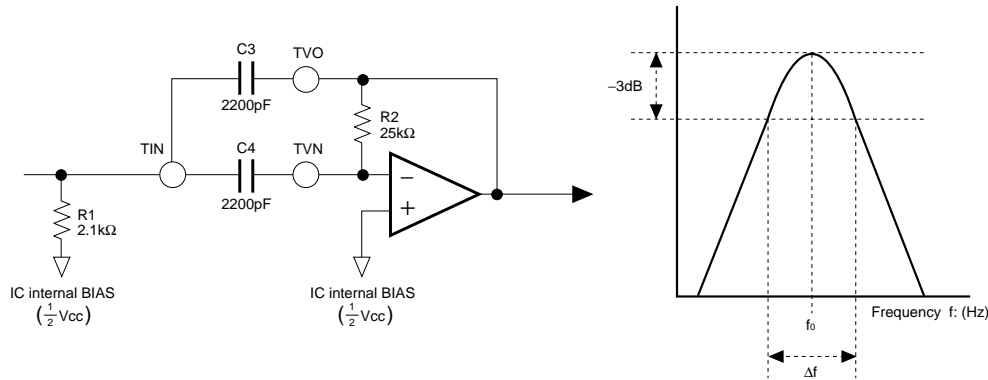

*The band-pass filter is constructed using a multiple-feedback active filter.
 f_0 can be varied by changing the value of the capacitors.

(Theoretical formulas)

$$f_0 = \frac{1}{2\pi} \times \left(\frac{1}{R_1 R_2 C_3 C_4} \right)^{\frac{1}{2}} \quad Q \cong \left(\left(\frac{R_1}{R_2 C_3 C_4} \right)^{\frac{1}{2}} \times (C_3 + C_4) \right)^{-1}$$

$$G = \frac{R_2}{5k\Omega} \times \left(1 + \frac{C_3}{C_4} \right)^{-1}$$

Note : The filter gain is given by the formula on the left, but the total output gain is determined by this in combination with the internal circuit.

(When $R_1 = 2.1k\Omega$, $R_2 = 25k\Omega$, $C_3 = C_4 = C$)

$$f_0 = \frac{2.2 \times 10^{-5}}{C} \quad Q \cong 1.73 \quad G = 2.5$$

(4) I²C BUS control

High-frequency digital signals are input on the SCL and SDA terminals, so ensure that the wiring and PCB pattern is designed in such a way as to ensure that these signals do not interfere with the analog signal system.

If you are not using I²C BUS control (i.e. you are using DC control), connect the SCL, SDA and SASS terminals to GND (do not leave them disconnected).

(5) Step switching noise

The VC1, VC2, TC, BC and SC terminals have components connected to them the application example. The values of these components may need to be changed depending on the signal level setting and PCB pattern.

Investigate carefully before deciding on the values of the various circuit constants.

The equivalent circuit for these terminals is given below (an integrator circuit is set at the first stage to slow the variation).

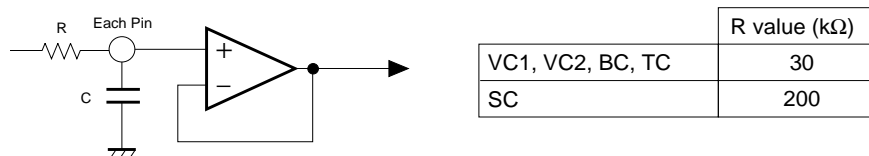

(6) Volume and tone level settings

This specification sheet gives reference values for the amount of attenuation and gain with respect to the serial control data. The internal D / A convertor is an R-2R circuit, and data exists for the places where continuous variation does not occur between data. Use this when fine setting is required. The setting limits are up to 8 bits for volume (256 steps) and 6 bits (64 steps) for tone.

BH3856S / BH3856FS

Audio ICs

(7) Digital / analog separation

The digital and analog power supplies and grounds for this IC (BH3856) are completely separate. The digital circuits are supplied from a stable reference source that is on the chip ($V_{ref}(3.8V)$). For this reason, there is no need to worry about timing shifts, on interference due to digital noise.

(8) Matrix surround

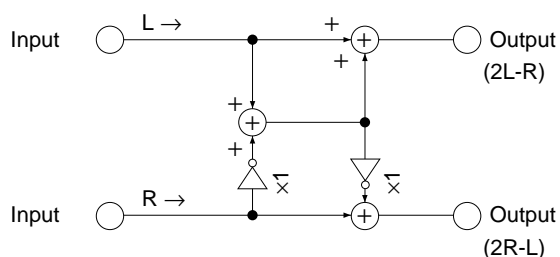

*The matrix surround circuit construction is as shown in the diagram above. The gain is obtained from the formulas in the diagram.

Phase Gain	0dB
Negative Phase Gain	6dB

(However, reverse-phase gain is for input to one channel only)

(9) DC control

An internal impedance of $30k\Omega$ is seen from the VC1, VC2, TC and BC terminals, and $200k\Omega$ is seen from the SC (pin 11) terminal, so with regard to DC control, we recommend direct control with the voltage source. When using variable volume, take the impedance into consideration when making the setting.

Note : The DC control voltage range is 0V to V_{ref} .

Do not apply voltages above V_{ref} to the terminals.

(10) GND

- As shown in the application circuit example, connect the external component GND to the analog GND.
- However, the GND for the capacitor connected to the V_{ref} terminal should be connected to the digital GND.
- If a capacitor with good high-frequency characteristics is connected in parallel with the capacitor connected to V_{ref} , the performances of the circuit with respect to static noise will improve (we recommend a ceramic capacitor of between $0.001\mu F$ and $0.1\mu F$)
- When using long digital and analog ground lines, take care to ensure that there is no potential difference between the two ground lines.

BH3856S / BH3856FS

Audio ICs

● **Electrical characteristic curves**

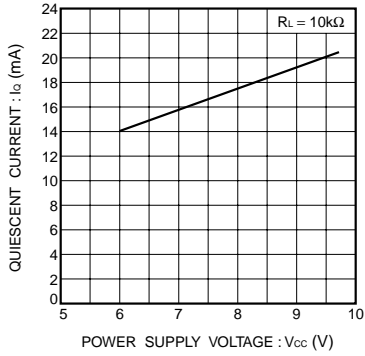

Fig. 3 Quiescent curve vs. Power supply voltage

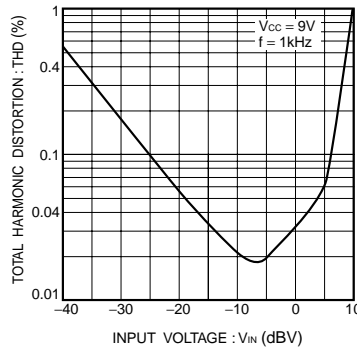

Fig.4 Total harmonic distortion vs. Input voltage

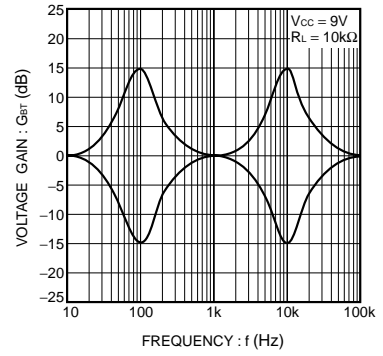
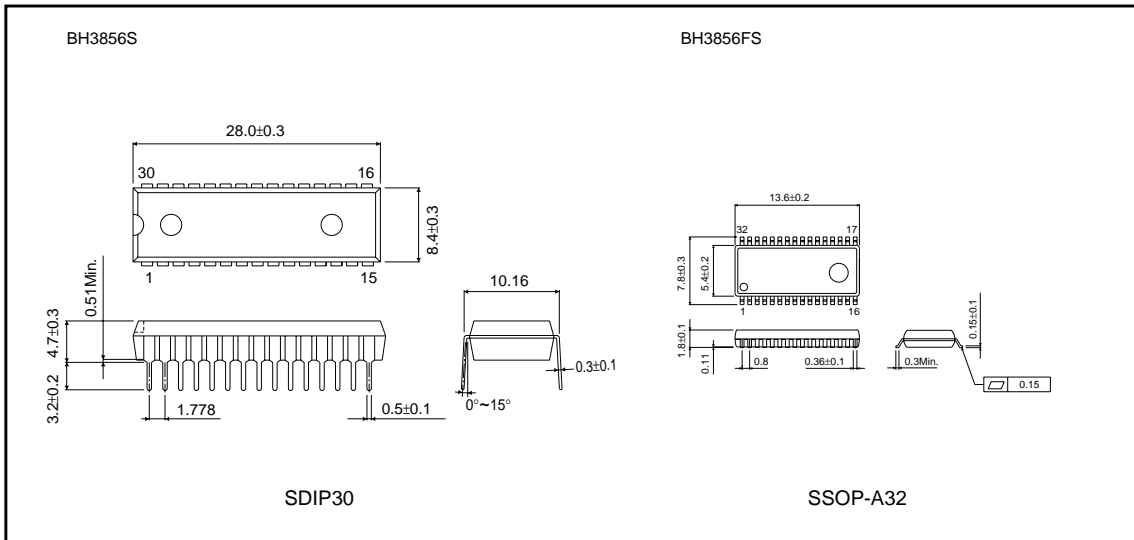

Fig. 5 Output gain vs. Frequency

● **External dimensions (Units : mm)**



Appendix

Notes

- No technical content pages of this document may be reproduced in any form or transmitted by any means without prior permission of ROHM CO.,LTD.
- The contents described herein are subject to change without notice. The specifications for the product described in this document are for reference only. Upon actual use, therefore, please request that specifications to be separately delivered.
- Application circuit diagrams and circuit constants contained herein are shown as examples of standard use and operation. Please pay careful attention to the peripheral conditions when designing circuits and deciding upon circuit constants in the set.
- Any data, including, but not limited to application circuit diagrams information, described herein are intended only as illustrations of such devices and not as the specifications for such devices. ROHM CO.,LTD. disclaims any warranty that any use of such devices shall be free from infringement of any third party's intellectual property rights or other proprietary rights, and further, assumes no liability of whatsoever nature in the event of any such infringement, or arising from or connected with or related to the use of such devices.
- Upon the sale of any such devices, other than for buyer's right to use such devices itself, resell or otherwise dispose of the same, no express or implied right or license to practice or commercially exploit any intellectual property rights or other proprietary rights owned or controlled by
- ROHM CO., LTD. is granted to any such buyer.
- Products listed in this document use silicon as a basic material.
Products listed in this document are no antiradiation design.

The products listed in this document are designed to be used with ordinary electronic equipment or devices (such as audio visual equipment, office-automation equipment, communications devices, electrical appliances and electronic toys).

Should you intend to use these products with equipment or devices which require an extremely high level of reliability and the malfunction of which would directly endanger human life (such as medical instruments, transportation equipment, aerospace machinery, nuclear-reactor controllers, fuel controllers and other safety devices), please be sure to consult with our sales representative in advance.

About Export Control Order in Japan

Products described herein are the objects of controlled goods in Annex 1 (Item 16) of Export Trade Control Order in Japan.

In case of export from Japan, please confirm if it applies to "objective" criteria or an "informed" (by MITI clause) on the basis of "catch all controls for Non-Proliferation of Weapons of Mass Destruction.