

## Excellent Integrated System Limited

Stocking Distributor

Click to view price, real time Inventory, Delivery & Lifecycle Information:

[IXYS Corporation](#)  
[VBO130-08NO7](#)

For any questions, you can email us directly:  
[sales@integrated-circuit.com](mailto:sales@integrated-circuit.com)

## Standard Rectifier Module

<b>1~ Rectifier</b>	
$V_{RRM}$	= 800 V
$I_{DAV}$	= 130 A
$I_{FSM}$	= 1800 A

### 1~ Rectifier Bridge

Part number

VBO130-08NO7

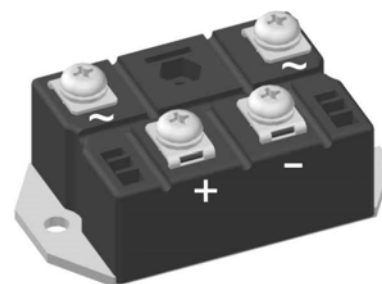

 E72873

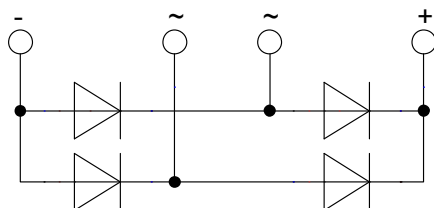

#### Features / Advantages:

- Package with DCB ceramic
- Improved temperature and power cycling
- Planar passivated chips
- Very low forward voltage drop
- Very low leakage current

#### Applications:

- Diode for main rectification
- For one phase bridge configurations
- Supplies for DC power equipment
- Input rectifiers for PWM inverter
- Battery DC power supplies
- Field supply for DC motors

#### Package: PWS-E

- Industry standard outline
- RoHS compliant
- Easy to mount with two screws
- Base plate: Copper internally DCB isolated
- Advanced power cycling

Rectifier				Ratings			Unit
Symbol	Definition	Conditions	min.	typ.	max.		
$V_{RSM}$	max. non-repetitive reverse blocking voltage				900	V	
$V_{RRM}$	max. repetitive reverse blocking voltage				800	V	
$I_R$	reverse current	$V_R = 800\text{ V}$	$T_{VJ} = 25^\circ\text{C}$		200	$\mu\text{A}$	
		$V_R = 800\text{ V}$	$T_{VJ} = 150^\circ\text{C}$		2	mA	
$V_F$	forward voltage drop	$I_F = 120\text{ A}$	$T_{VJ} = 25^\circ\text{C}$		1.10	V	
					1.26	V	
		$I_F = 240\text{ A}$	$T_{VJ} = 125^\circ\text{C}$		1.00	V	
					1.21	V	
$I_{DAV}$	bridge output current	$T_C = 110^\circ\text{C}$ rectangular $d = 0.5$	$T_{VJ} = 150^\circ\text{C}$		130	A	
$V_{F0}$	threshold voltage	} for power loss calculation only	$T_{VJ} = 150^\circ\text{C}$		0.77	V	
$r_F$	slope resistance				3.4	m $\Omega$	
$R_{thJC}$	thermal resistance junction to case				0.5	K/W	
$R_{thCH}$	thermal resistance case to heatsink			0.2		K/W	
$P_{tot}$	total power dissipation		$T_C = 25^\circ\text{C}$		250	W	
$I_{FSM}$	max. forward surge current	$t = 10\text{ ms}; (50\text{ Hz}), \text{ sine}$	$T_{VJ} = 45^\circ\text{C}$		1.80	kA	
					1.95	kA	
		$t = 8,3\text{ ms}; (60\text{ Hz}), \text{ sine}$	$V_R = 0\text{ V}$	$T_{VJ} = 150^\circ\text{C}$		1.53	kA
						1.65	kA
$I^2t$	value for fusing	$t = 10\text{ ms}; (50\text{ Hz}), \text{ sine}$	$T_{VJ} = 45^\circ\text{C}$		16.2	kA <sup>2</sup> s	
					15.7	kA <sup>2</sup> s	
		$t = 8,3\text{ ms}; (60\text{ Hz}), \text{ sine}$	$V_R = 0\text{ V}$	$T_{VJ} = 150^\circ\text{C}$		11.7	kA <sup>2</sup> s
						11.3	kA <sup>2</sup> s
$C_J$	junction capacitance	$V_R = 400\text{ V}; f = 1\text{ MHz}$	$T_{VJ} = 25^\circ\text{C}$	35		pF	

Package PWS-E		Ratings				
Symbol	Definition	Conditions	min.	typ.	max.	Unit
$I_{RMS}$	RMS current	per terminal			200	A
$T_{stg}$	storage temperature		-40		125	°C
$T_{vj}$	virtual junction temperature		-40		150	°C
<b>Weight</b>				273		g
$M_D$	mounting torque		4.25		5.75	Nm
$M_T$	terminal torque		4.25		5.75	Nm
$d_{Spp/App}$	creepage distance on surface   striking distance through air	terminal to terminal	12.0			mm
$d_{Spb/Apb}$		terminal to backside	26.0			mm
$V_{ISOL}$	isolation voltage	t = 1 second	3000			V
		t = 1 minute	2500			V

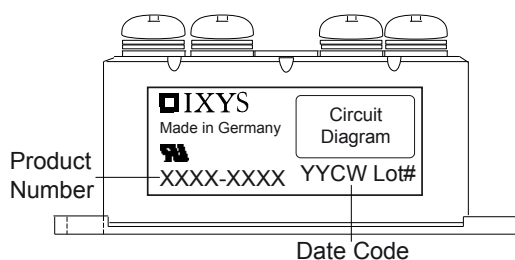

Ordering	Part Number	Marking on Product	Delivery Mode	Quantity	Code No.
Standard	VBO130-08NO7	VBO130-08NO7	Box	5	472301

**Equivalent Circuits for Simulation**

\* on die level

$T_{vj} = 150\text{ °C}$

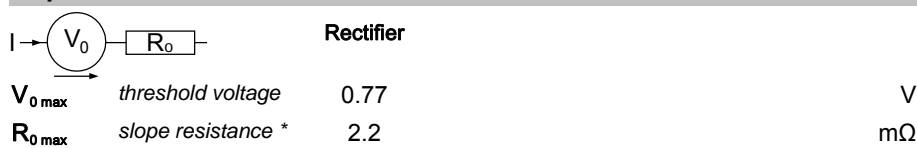

Outlines PWS-E

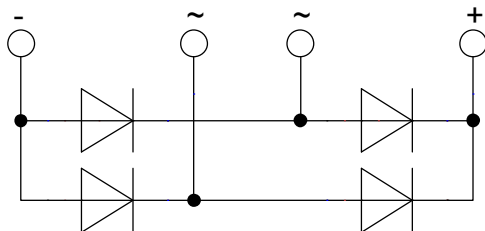
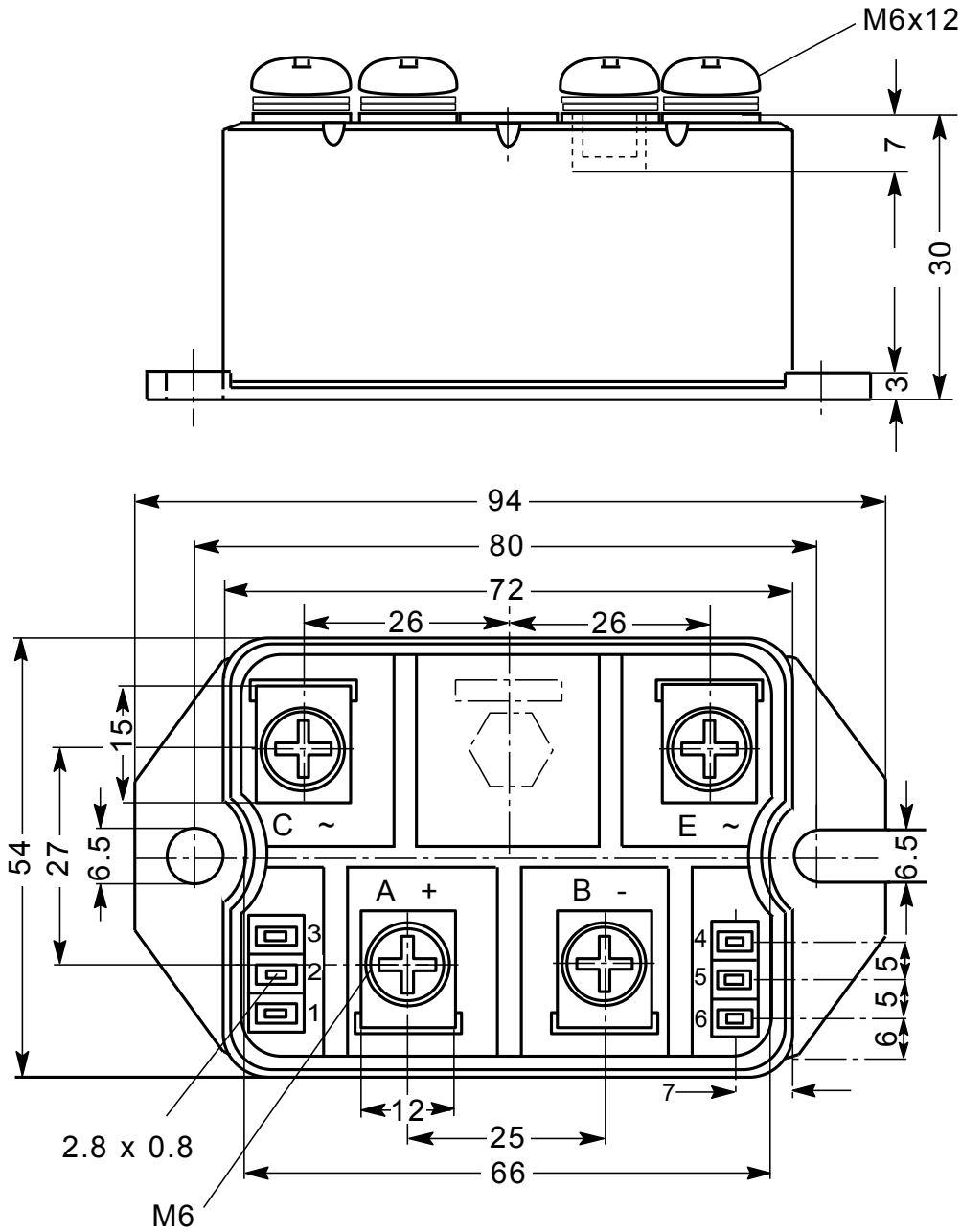

**Rectifier**

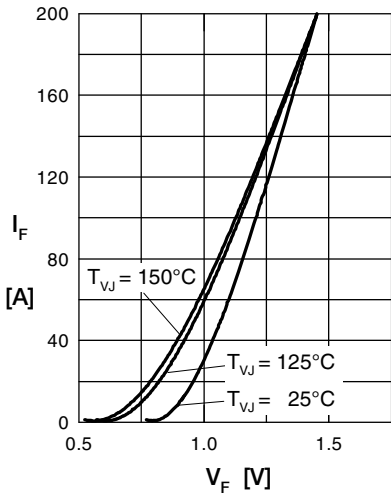

Fig. 1 Forward current vs. voltage drop per diode

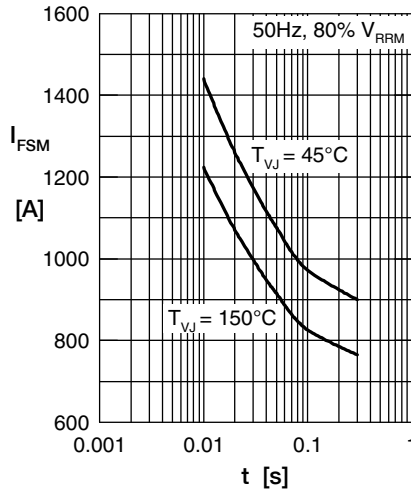

Fig. 2 Surge overload current vs. time per diode

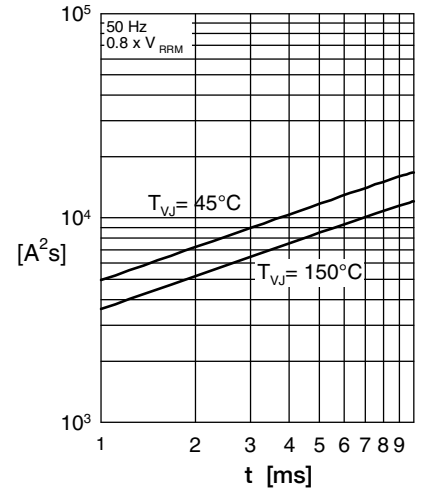

Fig. 3  $I^2t$  vs. time per diode

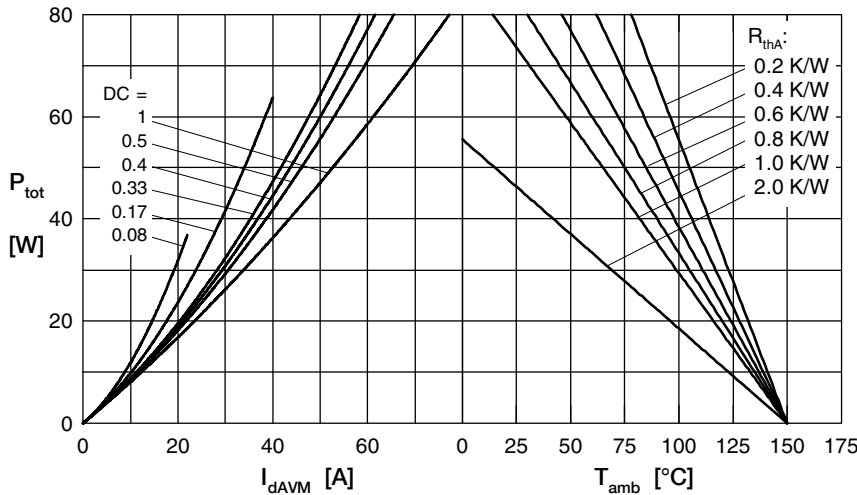

Fig. 4 Power dissipation vs. forward current and ambient temperature per diode

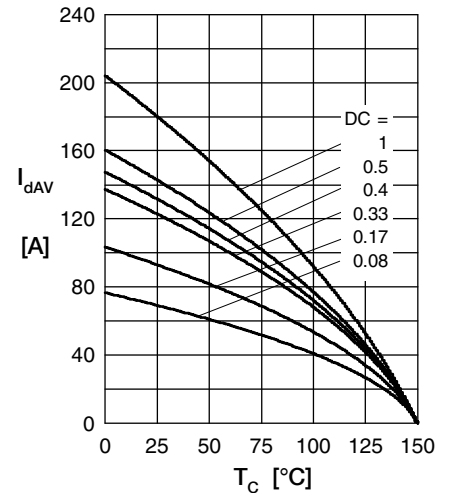

Fig. 5 Max. forward current vs. case temperature per diode

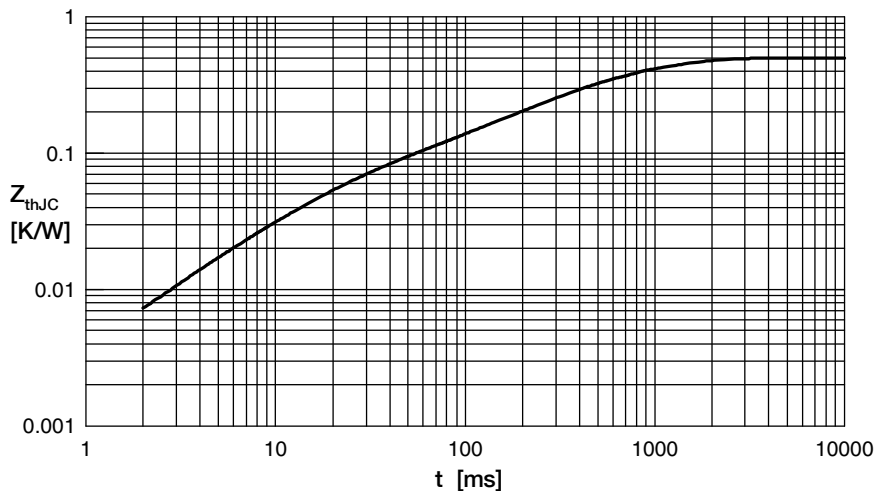

Fig. 6 Transient thermal impedance junction to case vs. time per diode

$R_i$	$t_i$
0.050	0.02
0.003	0.01
0.120	0.225
0.217	0.8
0.110	0.58