

Excellent Integrated System Limited

Stocking Distributor

Click to view price, real time Inventory, Delivery & Lifecycle Information:

For any questions, you can email us directly:

sales@integrated-circuit.com

PRODUCT DATASHEET

EVEREADY®

1-800-383-7323 USA/CAN
www.energizer.com

Eveready 1215

AA
SUPER HEAVY DUTY



Industry Standard Dimensions

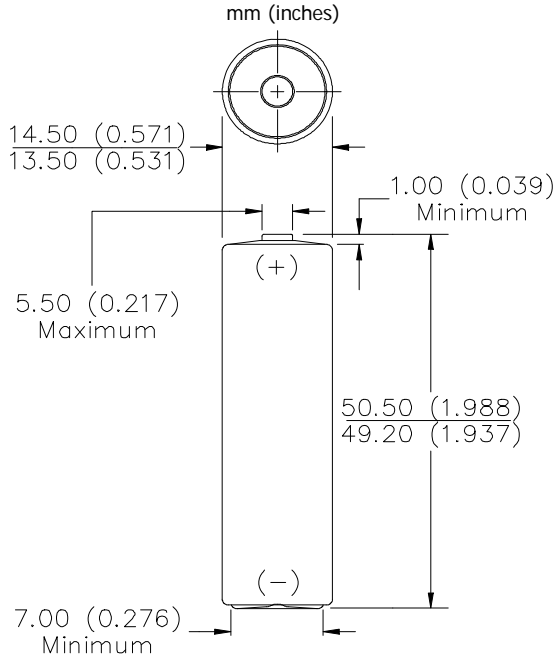

- Chemical System:** Zinc-Manganese Dioxide (Zn/MnO₂)
(No Added Mercury or Cadmium)
- Designation:** ANSI-15D, IEC-R6
- Battery Voltage:** 1.5 Volts
- Operating Temp:** -18°C to 55°C (0°F to 130°F)
- Average Weight:** 15.0 grams (0.5 oz.)
- Volume:** 8.0 cubic centimeters (0.5 cubic inch)
- Average Capacity:** 1,100 mAh to 0.8 volts
(Rated capacity at 25 mA continuous at 21°C)
- Cell:** One No. 15 (size "AA")
- Jacket:** Metal

INTERNAL RESISTANCE VS. TEMPERATURE

The measurement is an approximation of the battery's actual internal resistance. It is sensitive to the loads and operator technique.

Schedule: Background Load 750 ohms
Pulse Load 4.0 ohms
Pulse Duration 1 second

Temperature	Typical Ri (ohms)
45°C (113°F)	0.4
21°C (70°F)	0.5
0°C (32°F)	0.8
-21°C (-4°F)	5.0

CONSTANT RESISTANCE PERFORMANCE
Typical Service

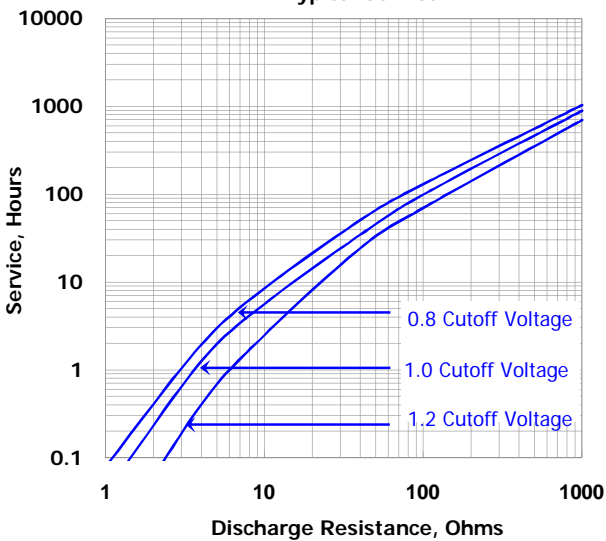

CONSTANT CURRENT DISCHARGE
Typical Service

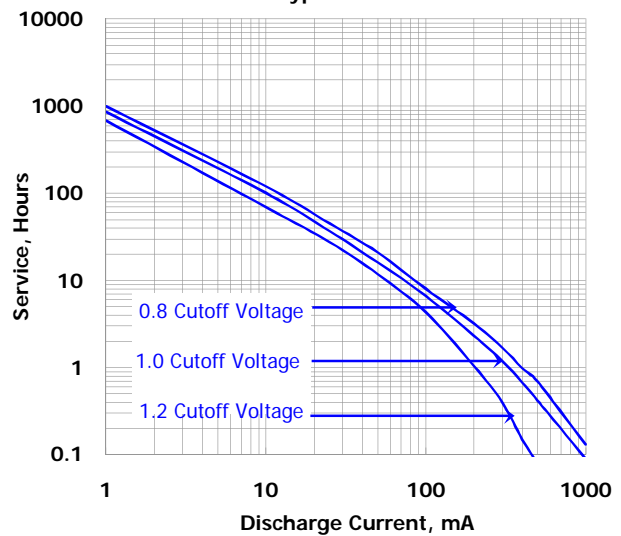

Important Notice

This data sheet contains information specific to batteries manufactured at the time of its publication.

Contents herein do not constitute a warranty.

Copyright © Eveready Battery Co. - All rights reserved

Eveready 1215

Industry Standard Tests (21° C)

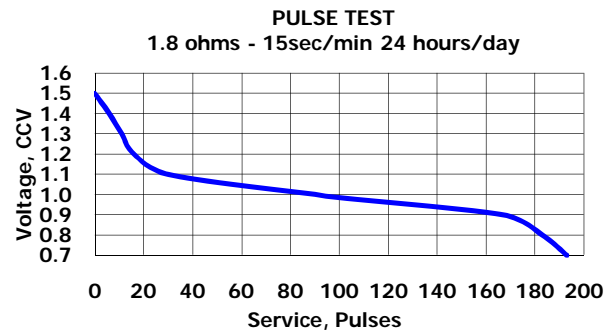
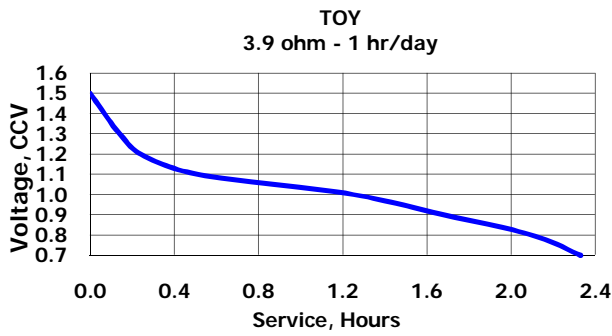
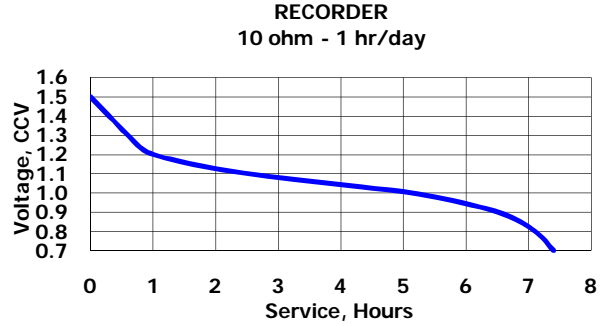
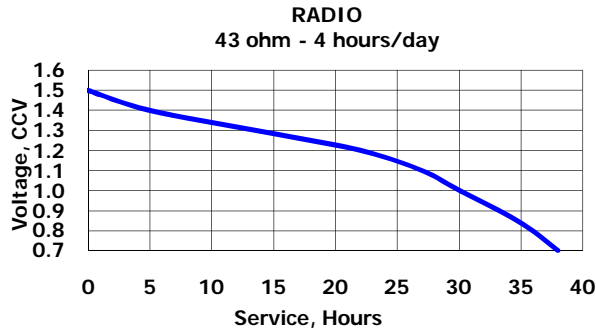

Important Notice

This data sheet contains information specific to batteries manufactured at the time of its publication.

Contents herein do not constitute a warranty.

Copyright © Eveready Battery Co. - All rights reserved