

Excellent Integrated System Limited

Stocking Distributor

Click to view price, real time Inventory, Delivery & Lifecycle Information:

[Sharp Microelectronics](#)
[PQ015EZ5MZZH](#)

For any questions, you can email us directly:

sales@integrated-circuit.com



PQxxxEZ5MZxH Series/PQxxxEZ01ZxH Series

PQxxxEZ5MZxH Series

PQxxxEZ01ZxH Series

Compact Surface Mount type
 Low Power-Loss Voltage Regulators

Features

1. Low voltage operation (Minimum operating voltage: 2.35V)
 2.5V input → available 1.5 to 1.8V
2. Low dissipation current
 Dissipation current at no load: MAX. 2mA
 Output OFF-state dissipation current: MAX. 5μA
3. Built-in overcurrent protection and overheat protection functions
4. RoHS directive compliant

Applications

1. Peripheral equipment of personal computers
2. Power supplies for various electronic equipment such as DVD player or STB

Model Line-up

Output current (I _o)	Package type	Output voltage (V _o)		
		1.5V	1.8V	2.5V
0.5A	Taping	PQ015EZ5MZPH	PQ018EZ5MZPH	PQ025EZ5MZPH
	Sleeve	PQ015EZ5MZZH	PQ018EZ5MZZH	PQ025EZ5MZZH
1A	Taping	PQ015EZ01ZPH	PQ018EZ01ZPH	PQ025EZ01ZPH
	Sleeve	PQ015EZ01ZZH	PQ018EZ01ZZH	PQ025EZ01ZZH
		3.0V	3.3V	
0.5A	Taping	PQ030EZ5MZPH	PQ033EZ5MZPH	
	Sleeve	PQ030EZ5MZZH	PQ033EZ5MZZH	
1A	Taping	PQ030EZ01ZPH	PQ033EZ01ZPH	
	Sleeve	PQ030EZ01ZZH	PQ033EZ01ZZH	

Outline Dimensions

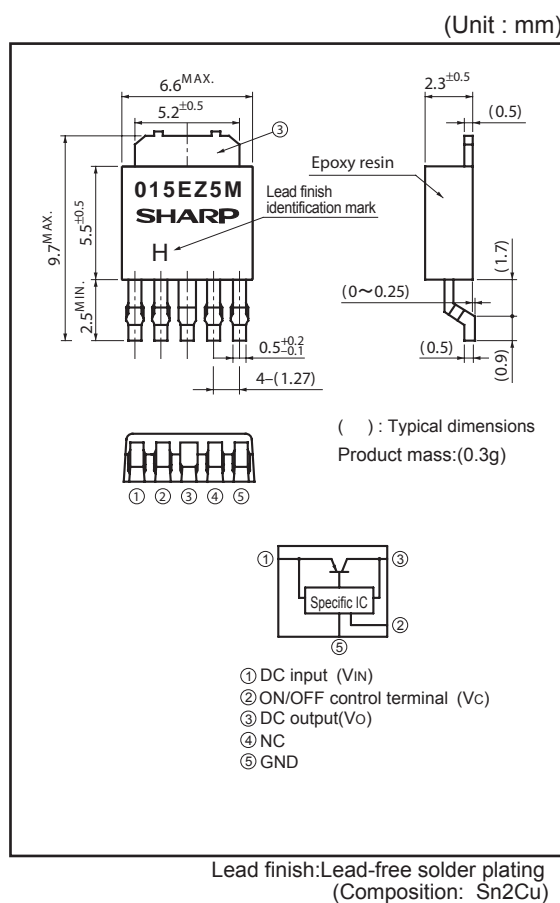

Absolute Maximum Ratings (Ta=25°C)

Parameter	Symbol	Rating	Unit
Input voltage	V _{IN}	10	V
*1 ON/OFF control terminal voltage	V _C	10	V
Output current	I _o	PQxxxEZ5MZxH Series	0.5
		PQxxxEZ01ZxH Series	1
*2 Power dissipation	P _D	8	W
*3 Junction temperature	T _j	150	°C
Operating temperature	T _{opr}	-40 to +85	°C
Storage temperature	T _{stg}	-40 to +150	°C
Soldering temperature	T _{sol}	260(10s)	°C

*1 All are open except GND and applicable terminals.
 *2 P_D: With infinite heat sink
 *3 Overheat protection may operate at T_j:125°C to 150°C

Electrical Characteristics

 (Unless otherwise specified, condition shall be $V_{IN}=V_O(TYP.)+1V$, $I_O=0.3A$, $V_C=2.7V$, $T_a=25^\circ C$ (PQxxxEZ5MZxH))

 (Unless otherwise specified, condition shall be $V_{IN}=V_O(TYP.)+1V$, $I_O=0.5A$, $V_C=2.7V$, $T_a=25^\circ C$ (PQxxxEZ01ZxH))

Parameter	Symbol	Conditions	MIN.	TYP.	MAX.	Unit
Input voltage	V_{IN}	—	Refer to below table			V
Output voltage	V_O	—	Refer to below table			V
Load regulation	R_{regL}	$I_O=5mA$ to 0.5A	—	0.2	2.0	%
		$I_O=5mA$ to 1A	—	0.2	2.0	%
Line regulation	R_{regI}	$V_{IN}=V_O(TYP.)+1V$ to $V_O(TYP.)+6V$, $I_O=5mA$	—	0.1	1.0	%
Temperature coefficient of output voltage	$T_C V_O$	$T_j=0$ to $125^\circ C$, $I_O=5mA$	—	± 0.01	—	%/ $^\circ C$
Ripple Rejection	RR	Refer to Fig.2	45	60	—	dB
*4 Dropout voltage	V_{I-O}	*5 $I_O=0.3A$	—	0.2	0.5	V
		*5 $I_O=0.5A$	—	0.2	0.5	V
*6 ON-state voltage for control	$V_{C(ON)}$	—	2.0	—	—	V
ON-state current for control	$I_{C(ON)}$	—	—	—	200	μA
OFF-state voltage for control	$V_{C(OFF)}$	—	—	—	0.8	V
OFF-state current for control	$I_{C(OFF)}$	$V_C=0.4V$	—	—	2	μA
Quiescent current	I_q	$I_O=0A$	—	1	2	mA
Output OFF-state dissipation current	I_{qs}	$I_O=0A$, $V_C=0.4V$	—	—	5	μA

*4 Applied PQ030EZ5MZxH, PQ033EZ5MZxH

*5 Input voltage shall be the value when output voltage is 95% in comparison with the initial value.

*6 In case of opening control terminal (2), output voltage turns off.

Input voltage range

 (Unless otherwise specified, condition shall be $I_O=0.3A$, $V_C=2.7V$, $T_a=25^\circ C$ (PQxxxEZ5MZxH))

 (Unless otherwise specified, condition shall be $I_O=0.5A$, $V_C=2.7V$, $T_a=25^\circ C$ (PQxxxEZ01ZxH))

Model No.	Symbol	Conditions	MIN.	TYP.	MAX.	Unit
PQ015EZ5MZxH / PQ015EZ01ZxH	V_{IN}	—	2.35	—	10	V
PQ018EZ5MZxH / PQ018EZ01ZxH	V_{IN}	—	2.35	—	10	V
PQ025EZ5MZxH / PQ025EZ01ZxH	V_{IN}	—	3.0	—	10	V
PQ030EZ5MZxH / PQ030EZ01ZxH	V_{IN}	—	3.5	—	10	V
PQ033EZ5MZxH / PQ033EZ01ZxH	V_{IN}	—	3.8	—	10	V

Output voltage

 (Unless otherwise specified, condition shall be $V_{IN}=V_O(TYP.)+1V$, $I_O=0.3A$, $V_C=2.7V$, $T_a=25^\circ C$ (PQxxxEZ5MZxH))

 (Unless otherwise specified, condition shall be $V_{IN}=V_O(TYP.)+1V$, $I_O=0.5A$, $V_C=2.7V$, $T_a=25^\circ C$ (PQxxxEZ01ZxH))

Model No.	Symbol	Conditions	MIN.	TYP.	MAX.	Unit
PQ015EZ5MZxH / PQ015EZ01ZxH	V_O	—	1.45	1.5	1.55	V
PQ018EZ5MZxH / PQ018EZ01ZxH	V_O	—	1.75	1.8	1.85	V
PQ025EZ5MZxH / PQ025EZ01ZxH	V_O	—	2.438	2.5	2.562	V
PQ030EZ5MZxH / PQ030EZ01ZxH	V_O	—	2.925	3	3.075	V
PQ033EZ5MZxH / PQ033EZ01ZxH	V_O	—	3.218	3.3	3.382	V



Fig.1 Test Circuit

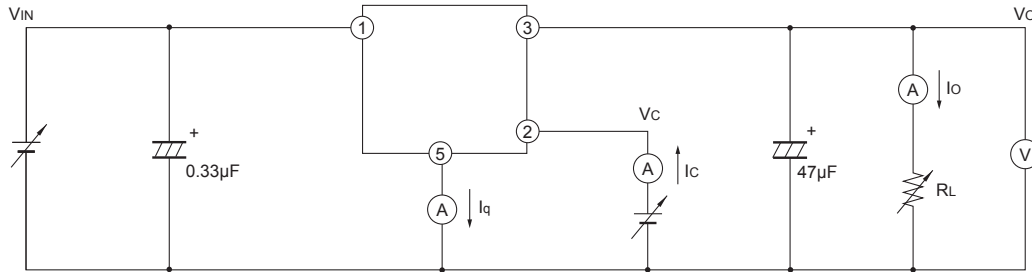
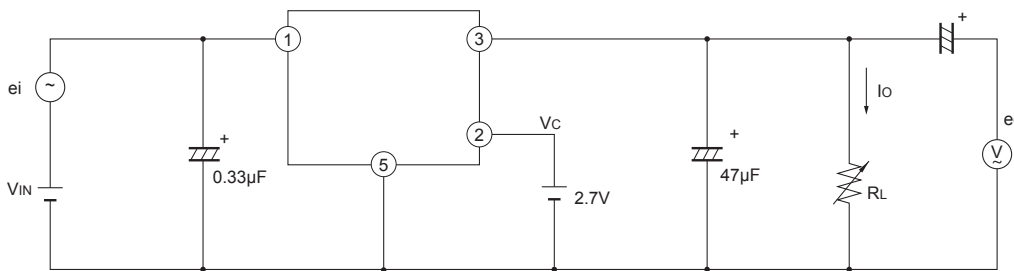
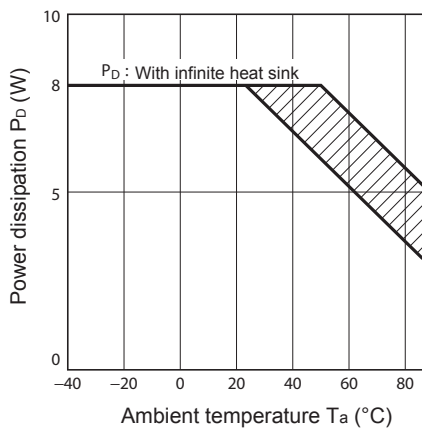

Fig.2 Test Circuit for Ripple Rejection



f=120Hz(sine wave)
ei(rms)=0.5V
VIN= Vo(TYP)+0.5V
Io=0.3A
RR=20log(ei(rms)/eo(rms))

Fig.3 Power Dissipation vs. Ambient Temperature



Note) Oblique line portion: Overheat protection may operate in this area.

Fig.4 Overcurrent Protection Characteristics (PQ015EZ5MZxH)

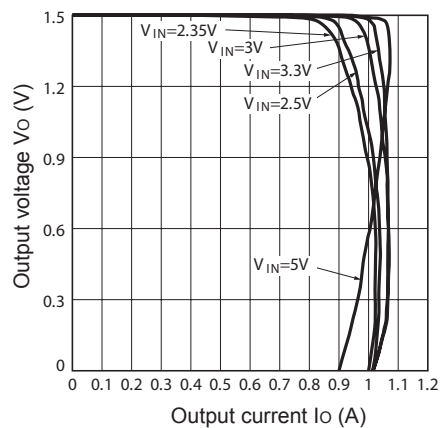

Fig.5 Overcurrent Protection Characteristics (PQ018EZ5MZxH)

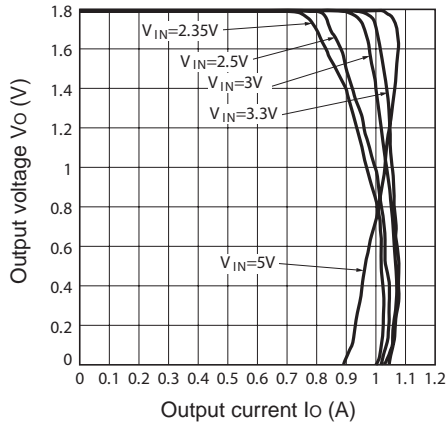

Fig.6 Overcurrent Protection Characteristics (PQ025EZ5MZxH)

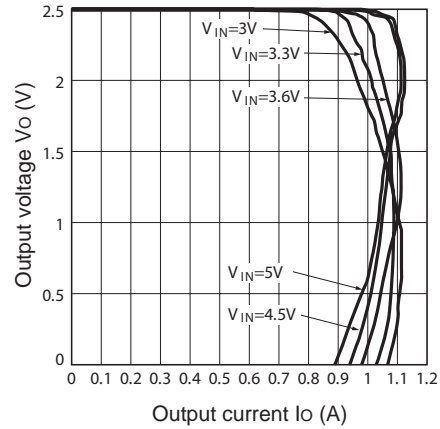

Fig.7 Overcurrent Protection Characteristics (PQ030EZ5MZxH)

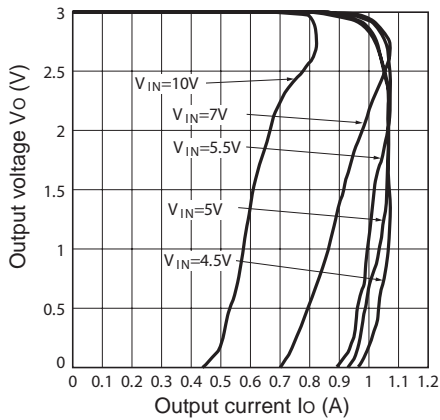

Fig.8 Overcurrent Protection Characteristics (PQ033EZ5MZxH)

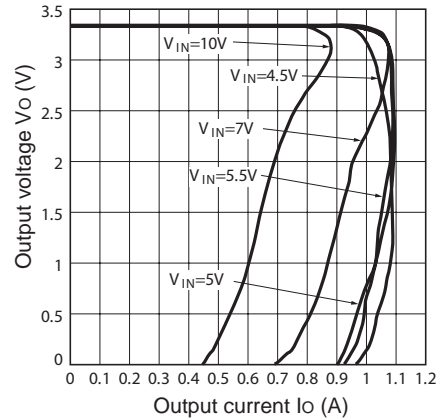

Fig.9 Overcurrent Protection Characteristics (PQ015EZ01ZxH)

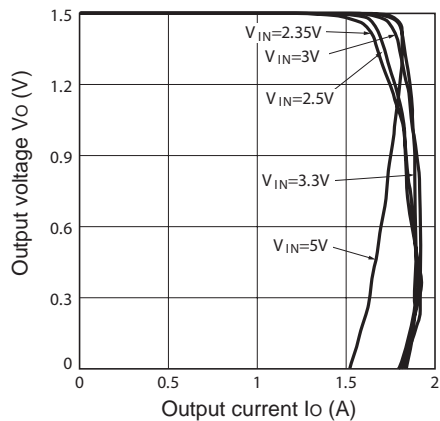

Fig.10 Overcurrent Protection Characteristics (PQ018EZ01ZxH)

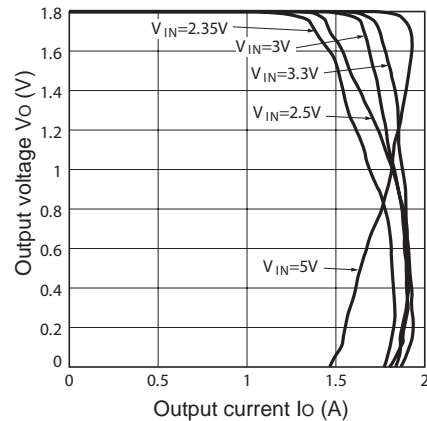



Fig.11 Overcurrent Protection Characteristics (PQ025EZ01ZxH)

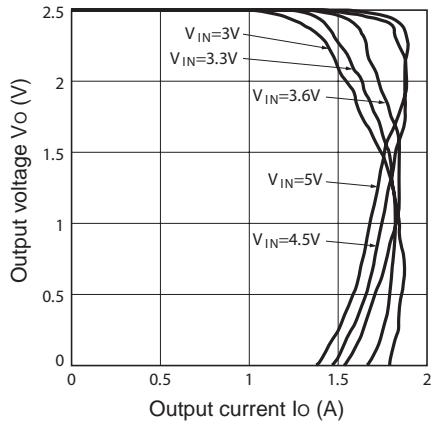

Fig.12 Overcurrent Protection Characteristics (PQ030EZ01ZxH)

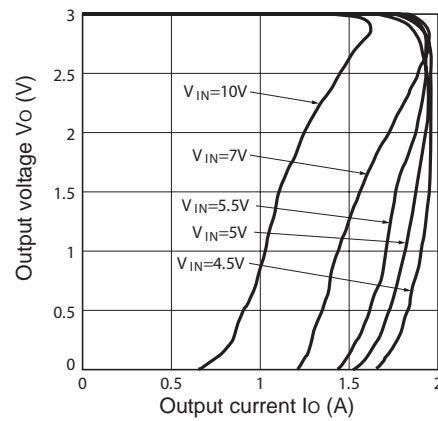

Fig.13 Overcurrent Protection Characteristics (PQ033EZ01ZxH)

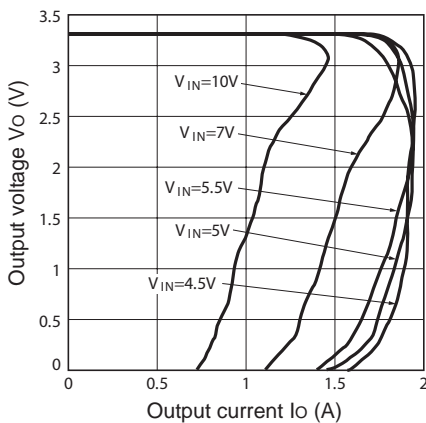

Fig.14 Output Voltage vs. Ambient Temperature (PQ015EZ5MZxH / PQ015EZ01ZxH)

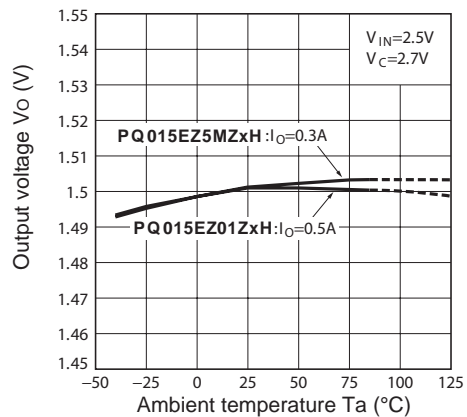

Fig.15 Output Voltage vs. Ambient Temperature (PQ018EZ5MZxH / PQ018EZ01ZxH)

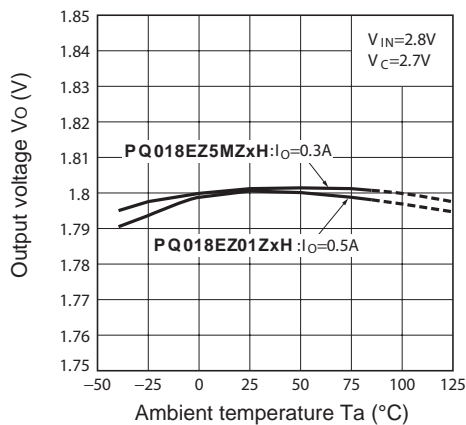

Fig.16 Output Voltage vs. Ambient Temperature (PQ025EZ5MZxH / PQ025EZ01ZxH)

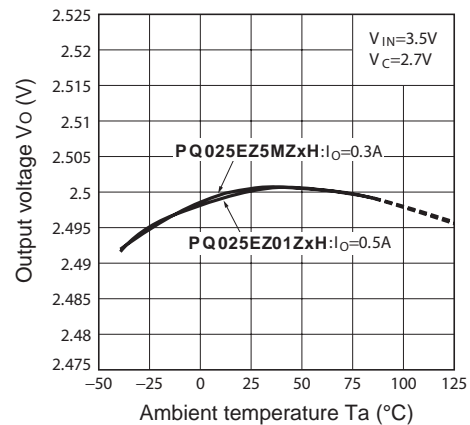



Fig.17 Output Voltage vs. Ambient Temperature (PQ030EZ5MZxH / PQ030EZ01ZxH)

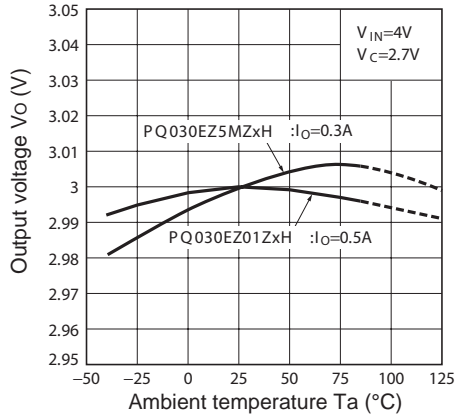

Fig.18 Output Voltage vs. Ambient Temperature (PQ033EZ5MZxH / PQ033EZ01ZxH)

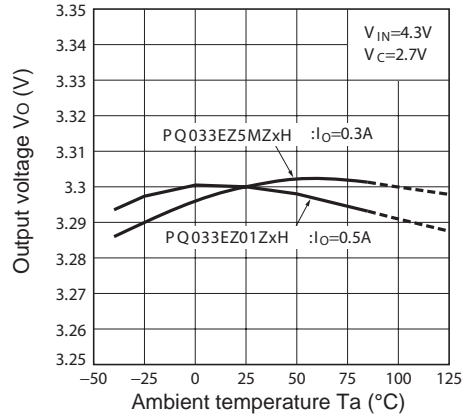

Fig.19 Output Voltage vs. Input Voltage (PQ015EZ5MZxH)

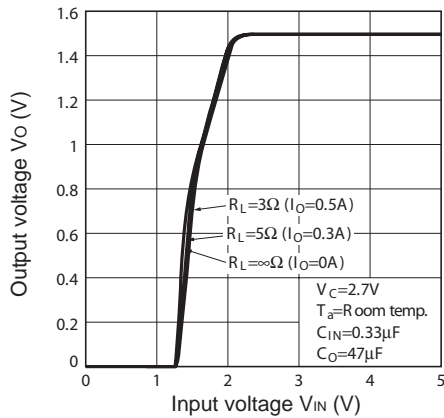

Fig.20 Output Voltage vs. Input Voltage (PQ018EZ5MZxH)

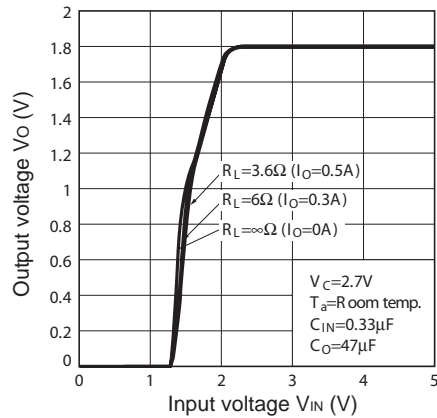

Fig.21 Output Voltage vs. Input Voltage (PQ025EZ5MZxH)

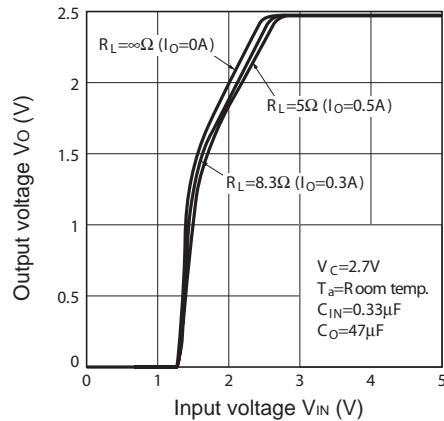

Fig.22 Output Voltage vs. Input Voltage (PQ030EZ5MZxH)

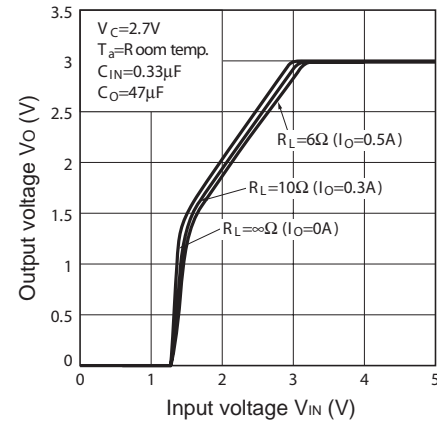



Fig.23 Output Voltage vs. Input Voltage (PQ033EZ5MZxH)

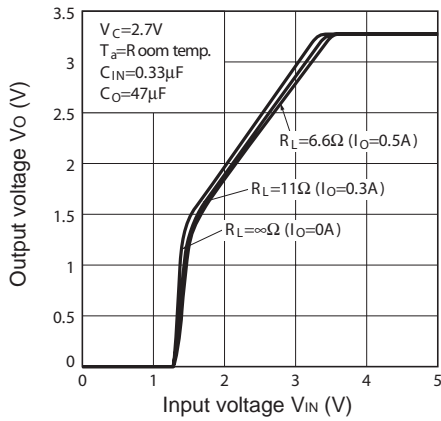

Fig.24 Output Voltage vs. Input Voltage (PQ015EZ01ZxH)

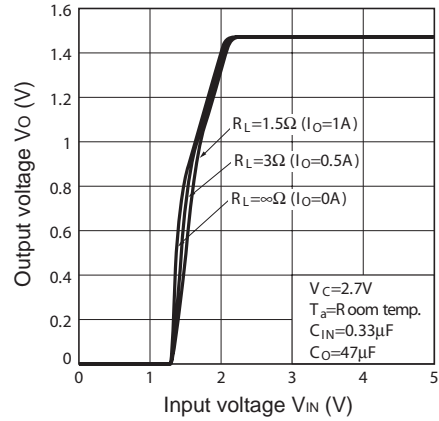

Fig.25 Output Voltage vs. Input Voltage (PQ018EZ01ZxH)

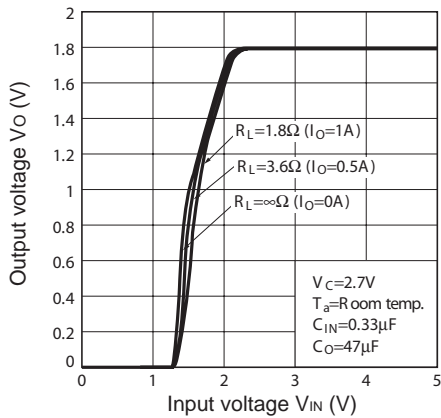

Fig.26 Output Voltage vs. Input Voltage (PQ025EZ01ZxH)

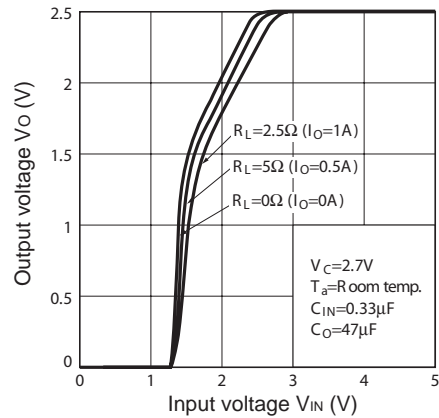

Fig.27 Output Voltage vs. Input Voltage (PQ030EZ01ZxH)

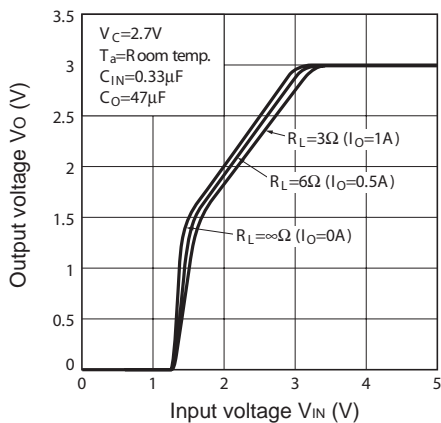

Fig.28 Output Voltage vs. Input Voltage (PQ033EZ01ZxH)

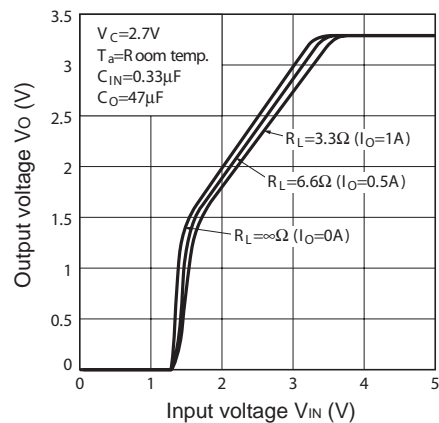

Fig.29 Circuit Operating Current vs. Input Voltage (PQ015EZ5MZxH)

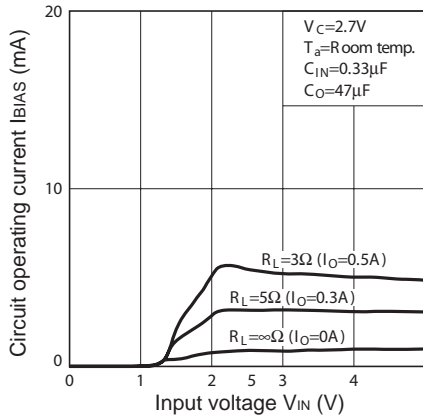

Fig.30 Circuit Operating Current vs. Input Voltage (PQ018EZ5MZxH)

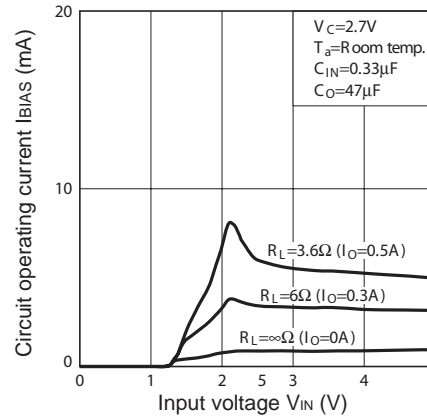

Fig.31 Circuit Operating Current vs. Input Voltage (PQ025EZ5MZxH)

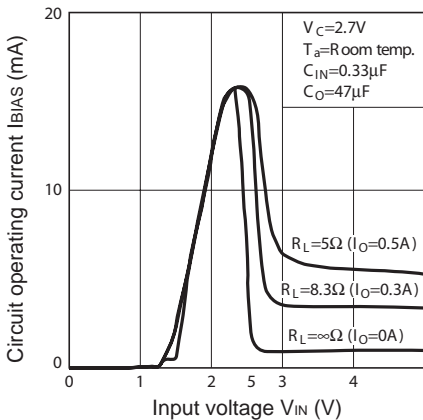

Fig.32 Circuit Operating Current vs. Input Voltage (PQ030EZ5MZxH)

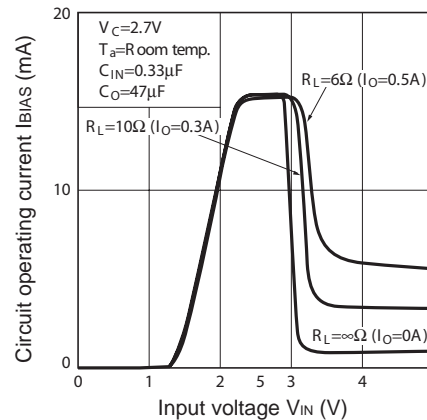

Fig.33 Circuit Operating Current vs. Input Voltage (PQ033EZ5MZxH)

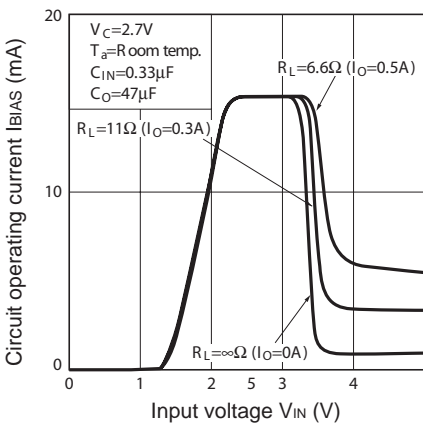

Fig.34 Circuit Operating Current vs. Input Voltage (PQ015EZ01ZxH)

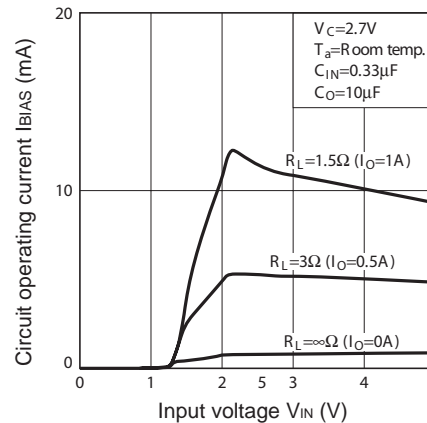



Fig.35 Circuit Operating Current vs. Input Voltage (PQ018EZ01ZxH)

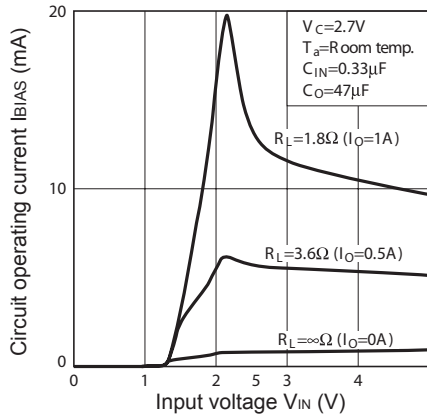

Fig.36 Circuit Operating Current vs. Input Voltage (PQ025EZ01ZxH)

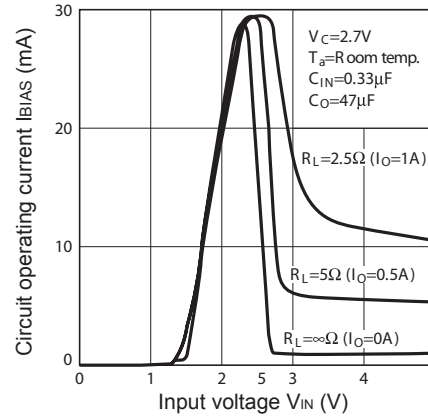

Fig.37 Circuit Operating Current vs. Input Voltage (PQ030EZ01ZxH)

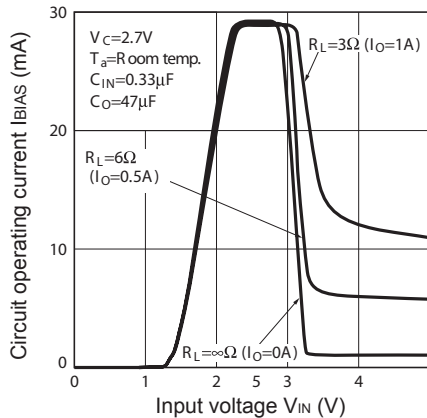

Fig.38 Circuit Operating Current vs. Input Voltage (PQ033EZ01ZxH)

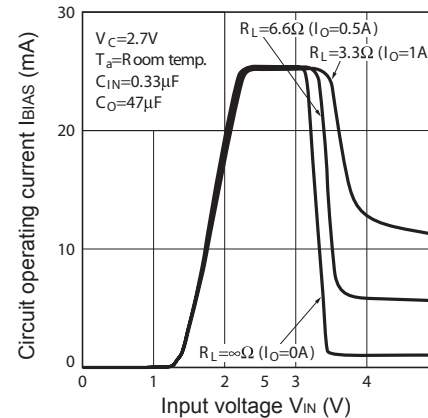

Fig.39 Quiescent Current vs. Junction Temperature

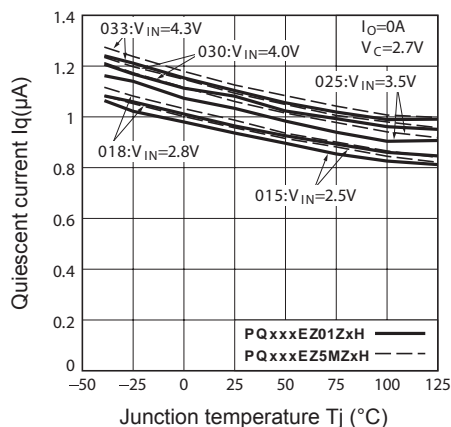

Fig.40 Dropout Voltage vs. Junction Temperature

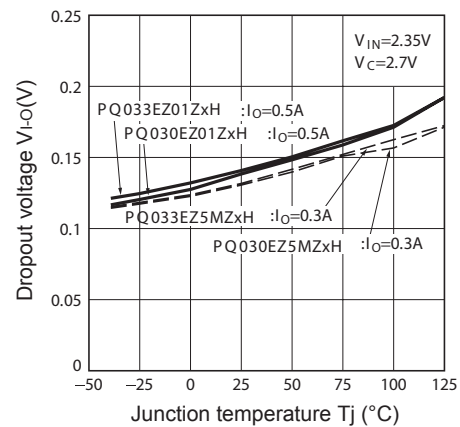

Fig.41 Ripple Rejection vs. Input Ripple Frequency

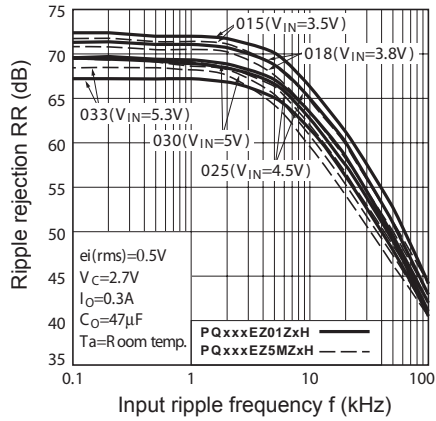

Fig.42 Ripple Rejection vs. Output Current

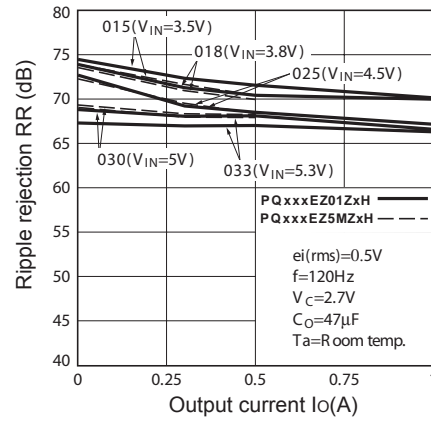

Fig.43 Typical Application

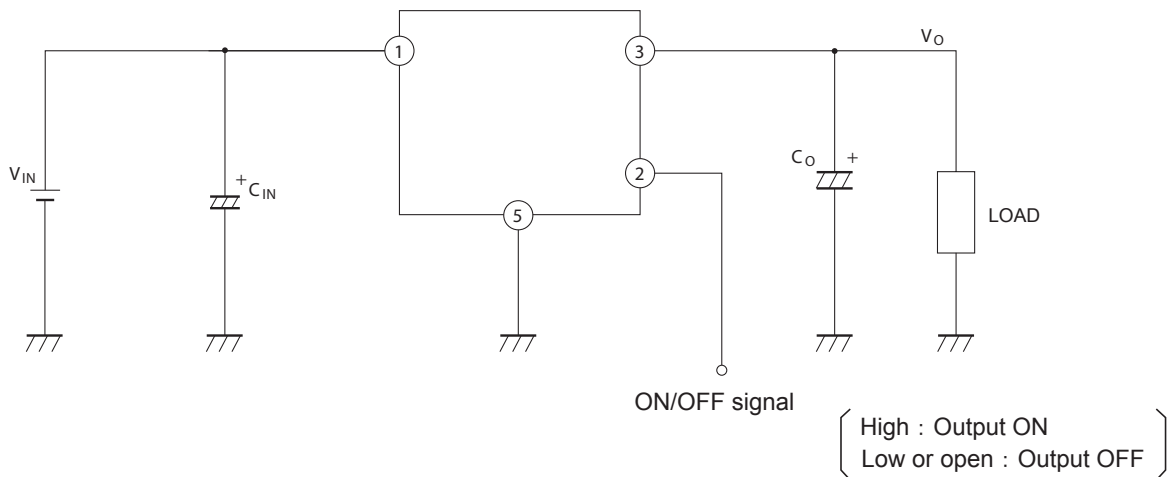
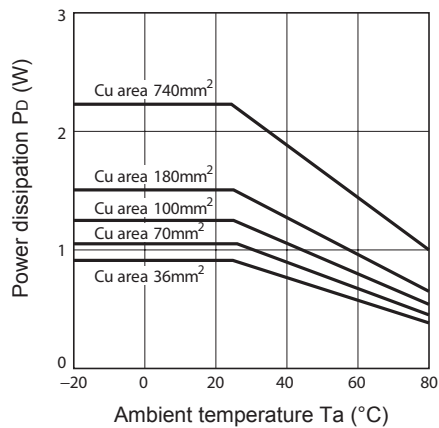
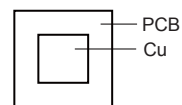

Fig.44 Power Dissipation vs. Ambient Temperature (Typical Value)



Mounting PCB



Material : Glass-cloth epoxy resin
Size : 50×50×1.6mm
Cu thickness : 35µm