

## Excellent Integrated System Limited

Stocking Distributor

Click to view price, real time Inventory, Delivery & Lifecycle Information:

[Nichicon](#)  
[LNT1K223MSM](#)

For any questions, you can email us directly:  
[sales@integrated-circuit.com](mailto:sales@integrated-circuit.com)

**ALUMINUM ELECTROLYTIC CAPACITORS**

**NT** series Screw Terminal Type, 105°C Standard



- Load life of 5,000 hours (2,000 hours for 10~250V,500V) application of rated ripple current at +105°C.
- Extended voltage range from 10V up to 500V.
- Extended range up to φ100 × 250L 2size.
- Available for adapted to the RoHS directive (2002/95/EC).

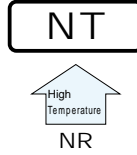

**Specifications**

Item	Performance Characteristics																																																																																																																																
Category Temperature Range	- 40 to +105°C (10 to 100V) , - 25 to +105°C (160 to 500V)																																																																																																																																
Rated Voltage Range	10 to 500V																																																																																																																																
Rated Capacitance Range	220 to 1500000μF																																																																																																																																
Capacitance Tolerance	±20% at 120Hz, 20°C																																																																																																																																
Leakage Current	After 5 minutes' application of rated voltage, leakage current is not more than $3\sqrt{CV}$ (μA) or 5mA, whichever is smaller. (at 20°C) [C:Rated Capacitance (μF), V:Voltage(V)]																																																																																																																																
tan δ (MAX)	Measurement frequency:120Hz, Temperature:20°C																																																																																																																																
	<table border="1"> <thead> <tr> <th>φD</th> <th>V</th> <th>10</th> <th>16</th> <th>25</th> <th>35</th> <th>50</th> <th>63</th> <th>80</th> <th>100</th> <th>160 to 250</th> <th>250 to 500</th> </tr> </thead> <tbody> <tr> <td rowspan="2">35</td> <td>80 to 100</td> <td>0.65</td> <td>0.45</td> <td>0.4</td> <td>0.3</td> <td>0.25</td> <td>0.25</td> <td>0.2</td> <td>0.12</td> <td>0.15</td> <td>0.2</td> </tr> <tr> <td>80 to 100</td> <td>0.9</td> <td>0.6</td> <td>0.5</td> <td>0.4</td> <td>0.25</td> <td>0.25</td> <td>0.2</td> <td>0.15</td> <td>0.15</td> <td>0.2</td> </tr> <tr> <td rowspan="2">51</td> <td>120</td> <td>0.85</td> <td>0.6</td> <td>0.5</td> <td>0.4</td> <td>0.3</td> <td>—</td> <td>—</td> <td>—</td> <td>—</td> <td>0.2</td> </tr> <tr> <td>100</td> <td>—</td> <td>—</td> <td>0.65</td> <td>—</td> <td>0.35</td> <td>0.3</td> <td>0.25</td> <td>0.2</td> <td>0.2</td> <td>0.2</td> </tr> <tr> <td rowspan="2">63.5</td> <td>110 to 130</td> <td>1.2</td> <td>0.8</td> <td>0.7</td> <td>0.5</td> <td>0.35</td> <td>0.3</td> <td>—</td> <td>—</td> <td>0.2</td> <td>0.2</td> </tr> <tr> <td>100</td> <td>2.0</td> <td>1.2</td> <td>0.9</td> <td>0.7</td> <td>0.55</td> <td>0.5</td> <td>0.3</td> <td>0.3</td> <td>—</td> <td>0.2</td> </tr> <tr> <td rowspan="2">76.2</td> <td>120 to 150</td> <td>2.0</td> <td>1.2</td> <td>0.9</td> <td>0.7</td> <td>0.55</td> <td>0.5</td> <td>0.35</td> <td>0.3</td> <td>0.2</td> <td>0.2</td> </tr> <tr> <td>140 to 220</td> <td>2.4</td> <td>2.0</td> <td>1.5</td> <td>1.0</td> <td>0.75</td> <td>0.6</td> <td>0.4</td> <td>0.3</td> <td>0.25</td> <td>0.2</td> </tr> <tr> <td>90</td> <td>140 to 220</td> <td>2.4</td> <td>2.0</td> <td>1.5</td> <td>1.0</td> <td>0.75</td> <td>0.6</td> <td>0.4</td> <td>0.3</td> <td>0.25</td> <td>0.2</td> </tr> <tr> <td>100</td> <td>220 • 250</td> <td>2.4</td> <td>2.0</td> <td>1.5</td> <td>1.0</td> <td>0.75</td> <td>0.6</td> <td>0.4</td> <td>0.3</td> <td>0.25</td> <td>0.2</td> </tr> </tbody> </table>	φD	V	10	16	25	35	50	63	80	100	160 to 250	250 to 500	35	80 to 100	0.65	0.45	0.4	0.3	0.25	0.25	0.2	0.12	0.15	0.2	80 to 100	0.9	0.6	0.5	0.4	0.25	0.25	0.2	0.15	0.15	0.2	51	120	0.85	0.6	0.5	0.4	0.3	—	—	—	—	0.2	100	—	—	0.65	—	0.35	0.3	0.25	0.2	0.2	0.2	63.5	110 to 130	1.2	0.8	0.7	0.5	0.35	0.3	—	—	0.2	0.2	100	2.0	1.2	0.9	0.7	0.55	0.5	0.3	0.3	—	0.2	76.2	120 to 150	2.0	1.2	0.9	0.7	0.55	0.5	0.35	0.3	0.2	0.2	140 to 220	2.4	2.0	1.5	1.0	0.75	0.6	0.4	0.3	0.25	0.2	90	140 to 220	2.4	2.0	1.5	1.0	0.75	0.6	0.4	0.3	0.25	0.2	100	220 • 250	2.4	2.0	1.5	1.0	0.75	0.6	0.4	0.3	0.25	0.2
	φD	V	10	16	25	35	50	63	80	100	160 to 250	250 to 500																																																																																																																					
	35	80 to 100	0.65	0.45	0.4	0.3	0.25	0.25	0.2	0.12	0.15	0.2																																																																																																																					
		80 to 100	0.9	0.6	0.5	0.4	0.25	0.25	0.2	0.15	0.15	0.2																																																																																																																					
	51	120	0.85	0.6	0.5	0.4	0.3	—	—	—	—	0.2																																																																																																																					
		100	—	—	0.65	—	0.35	0.3	0.25	0.2	0.2	0.2																																																																																																																					
	63.5	110 to 130	1.2	0.8	0.7	0.5	0.35	0.3	—	—	0.2	0.2																																																																																																																					
		100	2.0	1.2	0.9	0.7	0.55	0.5	0.3	0.3	—	0.2																																																																																																																					
	76.2	120 to 150	2.0	1.2	0.9	0.7	0.55	0.5	0.35	0.3	0.2	0.2																																																																																																																					
		140 to 220	2.4	2.0	1.5	1.0	0.75	0.6	0.4	0.3	0.25	0.2																																																																																																																					
	90	140 to 220	2.4	2.0	1.5	1.0	0.75	0.6	0.4	0.3	0.25	0.2																																																																																																																					
100	220 • 250	2.4	2.0	1.5	1.0	0.75	0.6	0.4	0.3	0.25	0.2																																																																																																																						
Stability at Low Temperature	<table border="1"> <thead> <tr> <th>Rated voltage(V)</th> <th>10 to 100</th> <th>160 to 500</th> </tr> </thead> <tbody> <tr> <td>Impedance ratio Z - 25°C/Z+20°C</td> <td>—</td> <td>8</td> </tr> <tr> <td>ZT/Z20(MAX.) Z - 40°C/Z+20°C</td> <td>12</td> <td>—</td> </tr> </tbody> </table>	Rated voltage(V)	10 to 100	160 to 500	Impedance ratio Z - 25°C/Z+20°C	—	8	ZT/Z20(MAX.) Z - 40°C/Z+20°C	12	—																																																																																																																							
	Rated voltage(V)	10 to 100	160 to 500																																																																																																																														
	Impedance ratio Z - 25°C/Z+20°C	—	8																																																																																																																														
ZT/Z20(MAX.) Z - 40°C/Z+20°C	12	—																																																																																																																															
Measurement frequency : 120Hz																																																																																																																																	
Endurance	After an application of DC voltage (in the range of rated DC voltage even after over-lapping the specified ripple current) for 5000 hours (2000 hours for 10~250V,500V) at 105°C, capacitors meet the characteristic requirements listed at right.																																																																																																																																
	<table border="1"> <tr> <td>Capacitance change</td> <td>Within ±20% of initial value</td> </tr> <tr> <td>tan δ</td> <td>300% or less of initial specified value</td> </tr> <tr> <td>Leakage current</td> <td>Initial specified value or less</td> </tr> </table>	Capacitance change	Within ±20% of initial value	tan δ	300% or less of initial specified value	Leakage current	Initial specified value or less																																																																																																																										
	Capacitance change	Within ±20% of initial value																																																																																																																															
tan δ	300% or less of initial specified value																																																																																																																																
Leakage current	Initial specified value or less																																																																																																																																
Leakage current	Initial specified value or less																																																																																																																																
Shelf Life	After storing the capacitors under no load at 105°C for 1000 hours, and after performing voltage treatment based on JIS C 5101-4 clause 4.1 at 20°C, they will meet the requirements listed at right.																																																																																																																																
	<table border="1"> <tr> <td>Capacitance change</td> <td>Within ±20% of initial value</td> </tr> <tr> <td>tan δ</td> <td>300% or less of initial specified value</td> </tr> <tr> <td>Leakage current</td> <td>Initial specified value or less</td> </tr> </table>	Capacitance change	Within ±20% of initial value	tan δ	300% or less of initial specified value	Leakage current	Initial specified value or less																																																																																																																										
	Capacitance change	Within ±20% of initial value																																																																																																																															
tan δ	300% or less of initial specified value																																																																																																																																
Leakage current	Initial specified value or less																																																																																																																																
Leakage current	Initial specified value or less																																																																																																																																
Marking	Printed with white color letter on black sleeve.																																																																																																																																

**Drawing**

φ35 Screw terminal type

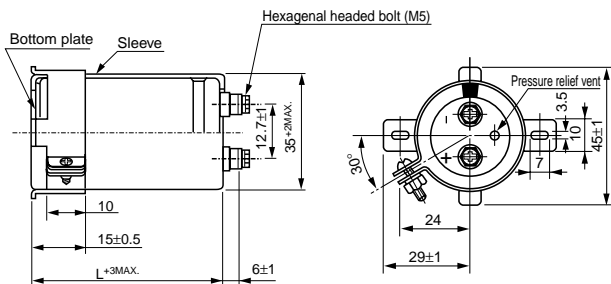

**Type numbering system**

Voltage 250V or less (Example : 250V 3300μF)

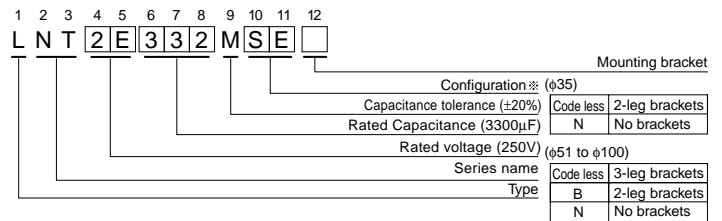

Voltage 350V or more (Example : 450V 2200μF)

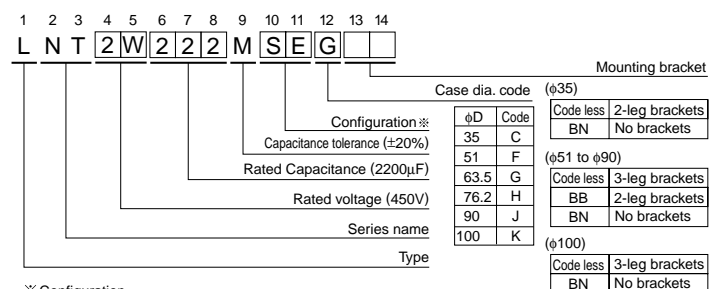

※ Configuration

Cr (III) Plating (RoHS compliant)	Cr (VI) Plating
SE	SM

Resin bushing available upon request.

※ Please contact to us if PVC less products are required.

● Dimension table in next page.

**ALUMINUM ELECTROLYTIC CAPACITORS**

**NT** series

Screw terminal type for  $\phi 51$  and larger

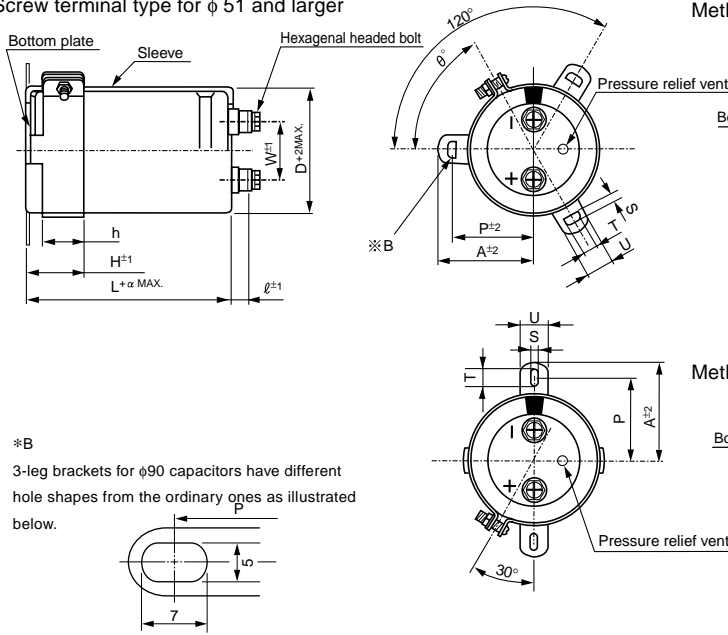

Method to mount resin bushing ( $\phi 76.2$ ) (Apply to  $L=150$  or more)

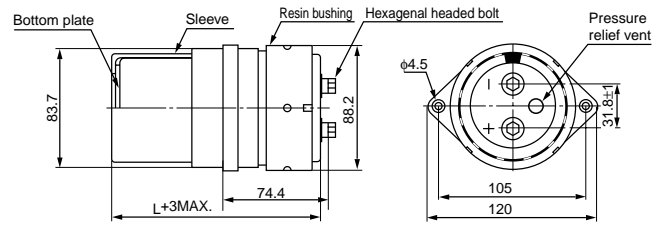

Method to mount resin bushing ( $\phi 90$ ) (Apply to  $L=150$  or more)

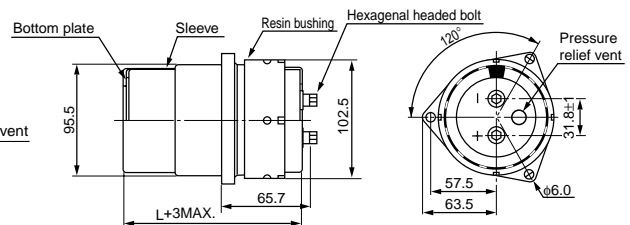

● Dimension of terminal pitch (W) and length ( $\ell$ ) and Nominal dia. of bolt (mm)

$\phi D$	W	$\ell$	$\alpha$	Nominal. of bolt
51	22.0	6	3	M5
63.5	28.6	6	3	M5
76.2	31.8	6	3	M5
90	31.8	6	3	M5
100	41.5	10	4	M8

● Dimensions of mounting bracket (mm)

Symbol	Leg Shape $\phi D$	3-Legs					2-Legs			
		51	63.5	76.2	90	100	51	63.5	76.2	90
P		32.5	38.1	44.5	50.8	56.3	33.2	40.5	46.5	53
A		38.5	43	49.2	58.5	62	40	46.5	53	59
T		7.5	8.0	7.0	8.0	8.0	6.0	7.0	6.0	6.0
S		5.0	5.0	5.0	5.0	5.0	4.5	4.5	4.5	4.5
U		12	14	14	18	16	14	14	14	14
$\theta^\circ$		60	60	60	60	60	30	30	30	30
H		20	25	30	35	36	25	35	35	35
h		15	20	24	25	30	15	20	20	20

■ Dimensions

V(Code)		10V (1A)		16V (1C)		25V (1E)		35V (1V)	
Surge		13V		20V		32V		44V	
Cap. ( $\mu F$ )	Code	Case size $\phi D \times L$ (mm)	Rated ripple	Case size $\phi D \times L$ (mm)	Rated ripple	Case size $\phi D \times L$ (mm)	Rated ripple	Case size $\phi D \times L$ (mm)	Rated ripple
10000	103							35×80	4.7
15000	153							35×80	5.1
22000	223					35×80	4.9	35×100	5.6
33000	333	35×80	4.8	35×80	5.2	35×100	6.2	51×80	7.4
47000	473	35×100	6.2	35×100	6.8	51×80	8.3	51×100	8.4
68000	683	51×80	6.8	51×80	7.1	51×120	10.2	51×120	12.3
100000	104	51×100	8.6	51×100	9.6	63.5×100	11.5	63.5×120	13.6
150000	154	51×120	10.8	51×120	11.0	63.5×120	13.8	76.2×120	15.1
220000	224	63.5×120	13.2	63.5×120	14.1	76.2×120	17.0	90×140	17.4
330000	334	76.2×120	15.8	76.2×120	20.6	90×140	20.8	90×170	21.3
470000	474	90×140	17.0	90×140	22.1	90×170	22.4	90×220	25.4
680000	684	90×170	18.4	90×170	24.0	90×220	24.2	100×250	27.5
1000000	105	90×220	20.1	90×220	26.1	100×220	26.4		
1500000	155	100×220	22.1	100×250	28.8				

Rated Ripple (Arms) at 105°C 120Hz

# ALUMINUM ELECTROLYTIC CAPACITORS

NT series

## ■ Dimensions

V(Code)		50V (1H)		63V (1J)		80V (1K)		100V (2A)	
Surge		63V		79V		100V		125V	
Cap.(μF)	Code	Case size φD×L (mm)	Rated ripple	Case size φD×L (mm)	Rated ripple	Case size φD×L (mm)	Rated ripple	Case size φD×L (mm)	Rated ripple
2200	222							35×80	2.4
3300	332							35×80	3.3
4700	472					35×80	3.5	35×100	3.8
6800	682					35×100	3.9	51×80	5.2
10000	103	35×80	4.9	35×100	5.0	51×80	5.4	51×100	6.7
15000	153	35×100	5.5	51×80	5.9	51×100	6.4	63.5×100	7.8
22000	223	51×80	6.3	51×100	6.9	63.5×100	8.4	76.2×100	9.9
33000	333	51×120	8.0	63.5×100	9.4	76.2×100	9.9	76.2×140	12.7
47000	473	63.5×100	9.9	63.5×120	11.2	76.2×120	13.4	90×140	17.0
68000	683	63.5×120	12.8	76.2×120	13.5	90×140	17.0	90×170	18.2
100000	104	76.2×120	16.8	90×140	17.8	90×170	18.6	90×220	20.6
150000	154	90×140	19.5	90×170	21.0	90×220	21.6	100×220	23.4
220000	224	90×170	22.0	90×220	23.7	100×250	24.8		
330000	334	90×220	24.3	100×250	26.1				
470000	474	100×250	26.1						

V(Code)		160V (2C)		200V (2D)		250V (2E)	
Surge		200V		250V		300V	
Cap.(μF)	Code	Case size φD×L (mm)	Rated ripple	Case size φD×L (mm)	Rated ripple	Case size φD×L (mm)	Rated ripple
680	681					35×80	1.4
1000	102	35×80	1.6	35×80	1.7	35×100	1.9
1500	152	35×80	2.1	35×100	2.3	51×80	2.4
2200	222	35×100	2.7	51×80	2.9	51×100	3.2
3300	332	51×80	3.8	51×100	3.9	63.5×100	4.3
4700	472	51×100	4.5	63.5×100	5.1	63.5×120	5.9
6800	682	63.5×100	6.8	63.5×120	7.0	76.2×120	7.1
10000	103	63.5×120	7.8	76.2×120	8.2	90×140	9.6
15000	153	76.2×120	9.8	76.2×140	10.4	90×170	12.7
22000	223	76.2×140	12.5	90×140	15.1	90×220	15.4
33000	333	90×140	13.4	90×220	16.6	100×250	17.0
47000	473	90×220	17.2	90×250	19.9		
68000	683	100×250	19.2				

V(Code)		350V (2V)		400V (2G)		450V (2W)		500V (2H)	
Surge		400V		450V		500V		550V	
Cap.(μF)	Code	Case size φD×L (mm)	Rated ripple	Case size φD×L (mm)	Rated ripple	Case size φD×L (mm)	Rated ripple	Case size φD×L (mm)	Rated ripple
220	221			35×80	1.6	35×80	1.8		
330	331	35×80	2.1	35×80	2.3	35×100	2.4	51×80	2.7
470	471	35×80	2.8	35×100	3.1	51×80	3.4	51×80	3.2
680	681	51×80	4.1	51×80	4.2	51×100	4.4	51×100	4.2
1000	102	51×80	6.5	51×80	6.6	51×100	7.0	51×120	5.5
1500	152	51×100	8.6	51×120	9.1	51×120	9.2	63.5×110	7.1
2200	222	51×120	11.0	63.5×100	11.5	63.5×110	11.8	63.5×130	9.3
2700	272	63.5×100	12.7	63.5×110	13.1	63.5×130	13.8	63.5×150	11.0
3300	332	63.5×110	14.4	63.5×130	15.4	63.5×150	16.5	63.5×170	12.9
3900	392	63.5×130	16.8	63.5×150	17.9	63.5×170	18.3	76.2×150	13.0
4700	472	63.5×150	19.8	63.5×170	20.7			76.2×190	17.2
		76.2×120	19.7	76.2×130	20.3	76.2×150	21.7	90×150	16.3
		63.5×170	22.7						
5600	562	76.2×130	22.2	76.2×150	23.7	76.2×190	26.4		
						90×150	24.1	90×150	17.8
6800	682	76.2×150	26.2	76.2×170	27.6				
				90×150	26.9	90×170	28.3	90×170	20.7
8200	822	76.2×170	30.3						
		90×150	29.3	90×170	31.0	90×190	32.5	90×220	25.5
10000	103	90×150	32.4	90×190	32.9	90×220	35.1	90×250	29.9
12000	123	90×190	36.0	90×220	38.3	90×230	39.2		
15000	153	90×220	42.9	100×220	44.5	90×250	45.6		
22000	223	100×250	48.0						

## ● Frequency coefficient of rated ripple current

Rated Ripple (Arms) at 105°C 120Hz

Frequency (Hz)	60	120	360	1k	10k or more
10 to 100V	0.90	1.00	1.08	1.15	1.15
160 to 250V	0.88	1.00	1.08	1.15	1.20
350 to 500V	0.82	1.00	1.20	1.35	1.40