

Excellent Integrated System Limited

Stocking Distributor

Click to view price, real time Inventory, Delivery & Lifecycle Information:

[Amphenol RF](#)
[82-5589](#)

For any questions, you can email us directly:
sales@integrated-circuit.com

Assembly Instructions-C19 Twinaxial

CLAMP PLUGS

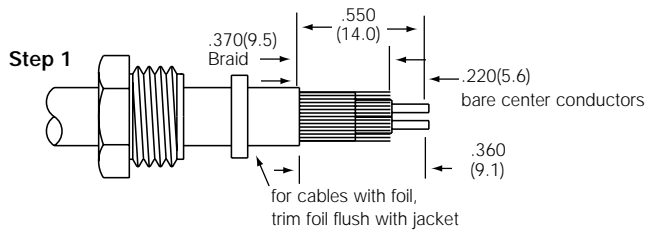
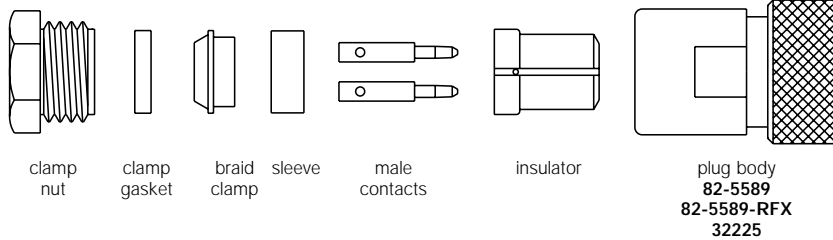

Step 1 Slide clamp nut and clamp gasket over cable end. V-groove in clamp gasket faces toward connector body. Strip cable to dimensions shown. **Important:** Do not nick insulation around center conductors. For solid core cables, lay braid back out of way while trimming core; then lay braid down again to facilitate Step 2.

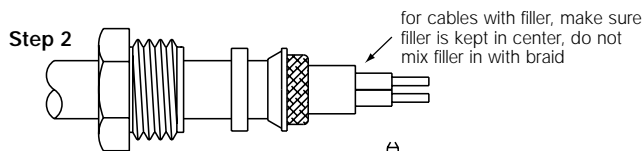

Step 2 Slide braid clamp over braid until inner shoulder butts against jacket. (Note: sharp edge of braid clamp goes toward V-groove in clamp gasket.) Fold braid back evenly over braid clamp as shown.

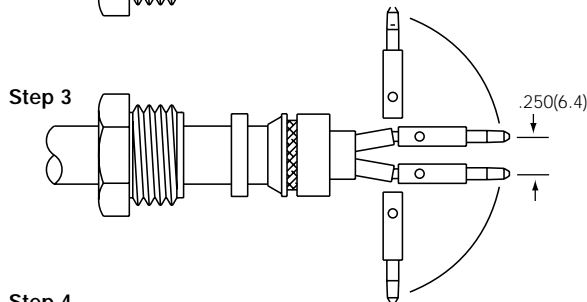

Step 3 Slide sleeve over cable so that braid bottoms inside sleeve. Solder contacts to conductors, using minimum heat. Remove any excess solder. Alternative method: Crimp center contacts using CTL Series tool number CTL-4 cavities B & C; or by using Die Set 227-1414 cavities B & C in tool frame 227-944 or in Pneumatic Crimp Tool 227-60. Bend conductors and contacts out and back to obtain .250(6.4) spacing between contacts.

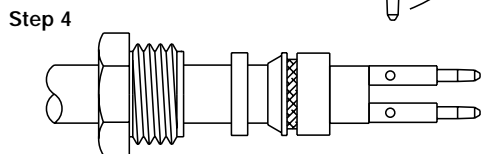

Step 4 Insert contacts into rear of insulator. (Note: for Belden 9207 and similar solid core cables, contact on bare copper conductor [or for Belden 8227 and similar air dielectric cables, the contact on white insulated conductor] goes into hole with dot next to it.) Slide insulator to butt against sleeve as shown.

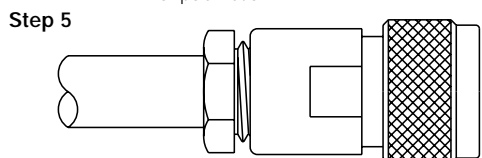
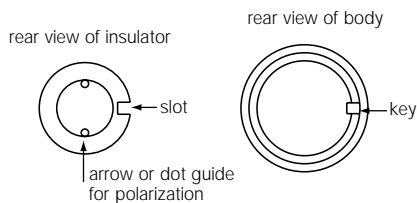

Step 5 Insert assembly into connector body, aligning slot of insulator with polarizing key in body. Tighten clamp nut to 50 lbf-in. (5.7 N-m) torque. Do not twist connector body.