

## Excellent Integrated System Limited

Stocking Distributor

Click to view price, real time Inventory, Delivery & Lifecycle Information:

[NJR/JRC Corporation](#)

[NJM2624AD#](#)

For any questions, you can email us directly:

[sales@integrated-circuit.com](mailto:sales@integrated-circuit.com)



# NJM2624A

## BRUSH LESS DC MOTOR PRE-DRIVER

### ■GENERAL DESCRIPTION

The **NJM2624A** is a 3-phase brushless DC motor pre-driver which requires external power-transistors suited to drive current of the motor.

The Run Enable function is used as PWM control besides of ON/OFF switched function.

### ■PACKAGE OUTLINE

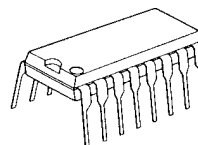

**NJM2624AD**

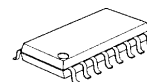

**NJM2624AM**



**NJM2624AV**

### ■FEATURES

- Operating Voltage (V<sup>+</sup>=4.5V to 18V)
- Low Operating Current (10mA max.)
- Run Enable
- Forward or Reverse Direction
- Output Switch Current (90mA typ.)
- Bipolar Technology
- Package Outline DIP16, DMP16, SSOP16

### ■PIN CONFIGURATION

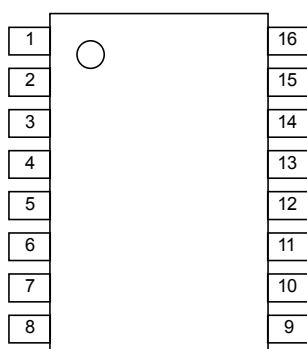

### PIN FUNCTION

- |                  |           |
|------------------|-----------|
| 1.H1-            | 9.GND     |
| 2.H1+            | 10.ON/OFF |
| 3.H2+            | 11.OUT1   |
| 4.H2-            | 12.OUT3   |
| 5.H3-            | 13.OUT5   |
| 6.H3+            | 14.OUT6   |
| 7.FR             | 15.OUT4   |
| 8.V <sup>+</sup> | 16.OUT2   |

# NJM2624A

## ■BLOCK DIAGRAM

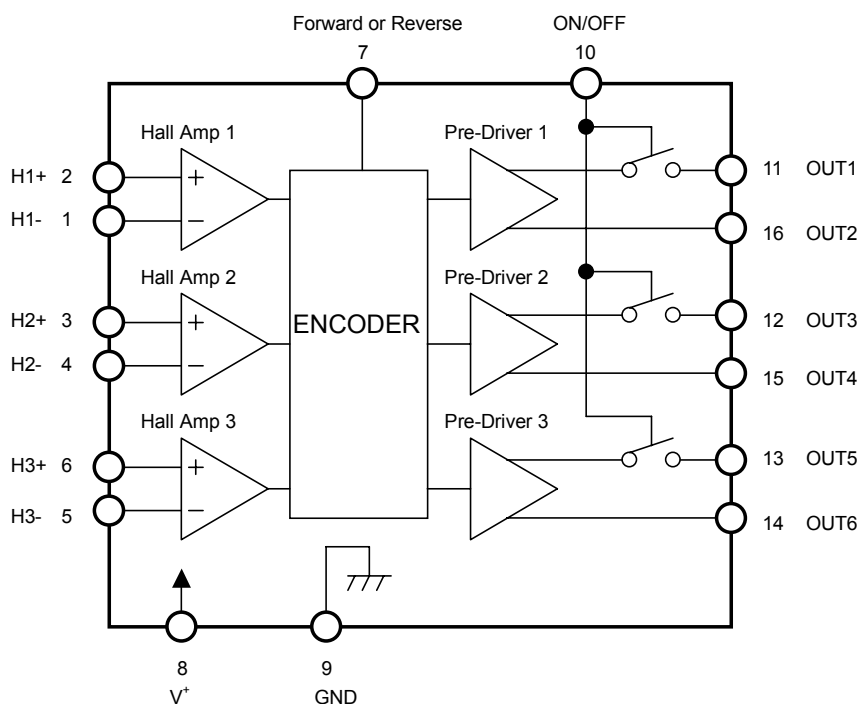

## ■ABSOLUTE MAXIMUM RATINGS (Ta=25°C)

PARAMETER	SYMBOL	RATINGS	UNIT
Supply Voltage	V <sup>+</sup>	20	V
Output Current	I <sub>o</sub>	100	mA
Power Dissipation	P <sub>D</sub>	(DIP16) 700 (DMP16) 350 (SSOP16) 300	mW
Operating Temperature Range	Topr	-25 ~ +85	°C
Storage Temperature Range	Tstg	-40 ~ +150	°C

# NJM2624A

## ■ELECTRICAL CHARACTERISTICS (V<sup>+</sup>=12V, Ta=25°C)

### Total Device

PARAMETER	SYMBOL	TEST CONDITIONS	MIN.	TYP.	MAX.	UNIT
Supply Voltage	V <sup>+</sup>		4.5	–	18	V
Supply Current	I <sub>CC</sub>	RL=∞ ON/OFF Terminal=OPEN	–	3.7	10	mA

### Hall Sensor Section

Input Offset Voltage	V <sub>IO</sub>	RL=470Ω	-4.2	–	4.2	mV
Input Common mode Voltage range	V <sub>ICM</sub>	RL=470Ω	1.5	–	10.5	V
Input Bias Current	I <sub>B</sub>		–	–	600	nA

### Output Section

Output Voltage 1	V <sub>OUT1</sub>	RL=470Ω, V <sup>+</sup> =12V	8.9	9.5	–	V
Output Voltage 2	V <sub>OUT2</sub>	RL=470Ω, V <sup>+</sup> =5V	–	3.5	–	V
Maximum Output Current 1	I <sub>OUT1</sub>	RL=100Ω, V <sup>+</sup> =12V	50	90	–	mA
Maximum Output Current 2	I <sub>OUT2</sub>	RL=100Ω, V <sup>+</sup> =5V	–	30	–	mA
Output Leak Current	I <sub>LEAK</sub>		–	–	5	μA

### Run Enable Section

Run Enable Voltage	V <sub>ON</sub>	RL=470Ω	1/2V <sup>+</sup> +0.5	–	–	V
Run Disable Voltage	V <sub>OFF</sub>	RL=470Ω	–	–	1/2V <sup>+</sup> -0.5	V
Output Voltage Undefined Area	V <sub>O-undef</sub>	RL=470Ω	1/2V <sup>+</sup> -0.5	1/2V <sup>+</sup>	1/2V <sup>+</sup> +0.5	V
Source Current 1	I <sub>ON1</sub>	ON/OFF Terminal=GND	–	250	400	μA

### Forward or Reverse Direction Section

Forward Direction	V <sub>F</sub>	RL=470Ω	1/2V <sup>+</sup> +0.5	–	–	V
Reverse Direction	V <sub>R</sub>	RL=470Ω	–	–	1/2V <sup>+</sup> -0.5	V
F/R Logic Undefined Area	V <sub>SW-undef</sub>	RL=470Ω	1/2V <sup>+</sup> -0.5	1/2V <sup>+</sup>	1/2V <sup>+</sup> +0.5	V
Source Current 2	I <sub>ON2</sub>	Forward or Reverse Terminal=GND	–	250	400	μA

# NJM2624A

## ■ TERMINAL DESCRIPTION

Pin No,	SYMBOL	FUNCTION	INSIDE EQUIVALENT CIRCUIT
2	H1+	Sensor Input 1 Non-Inverting Terminal	
3	H2+	Sensor Input 2 Non-Inverting Terminal	
6	H3+	Sensor Input 3 Non-Inverting Terminal	
1	H1-	Sensor Input 1 Inverting Terminal	
4	H2-	Sensor Input 2 Inverting Terminal	
5	H3-	Sensor Input 3 Inverting Terminal	
7	F/R	Forward or Reverse Direction Terminal	

# NJM2624A

## ■ TERMINAL DESCRIPTION

Pin No,	SYMBOL	FUNCTION	INSIDE EQUIVALENT CIRCUIT
8	V <sup>+</sup>	Power Supply	-
9	GND	Ground	-
10	ON/OFF	Output Run Enable Terminal	
11	OUT1	Internal Switching Transistor	
16	OUT2	Emitter Follower	
12	OUT3		
15	OUT4		
13	OUT5		
14	OUT6		

# NJM2624A

## ■ TYPICAL APPLICATION

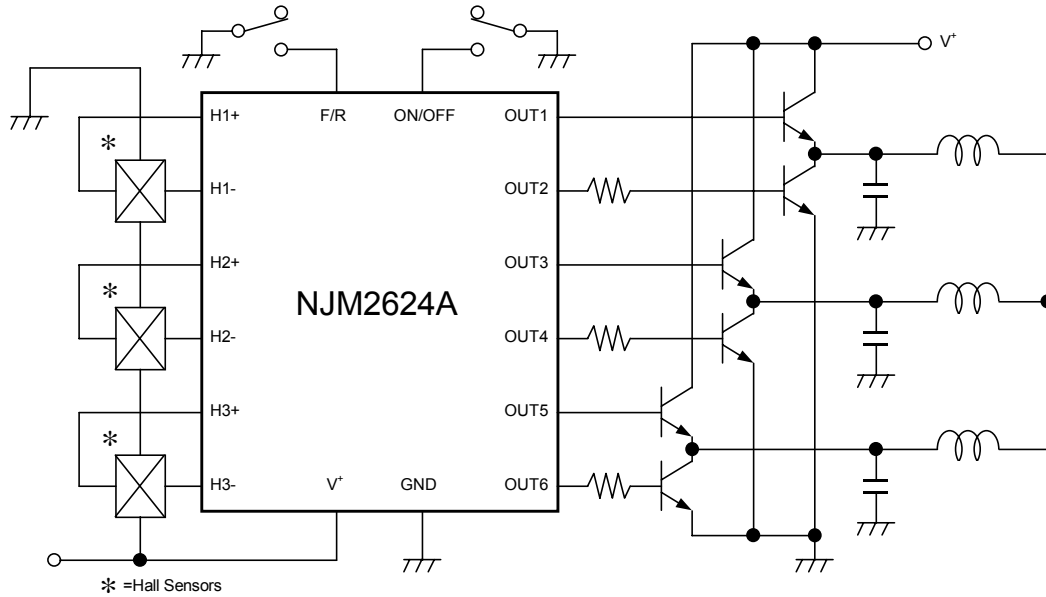

## ■ TIMING CHART

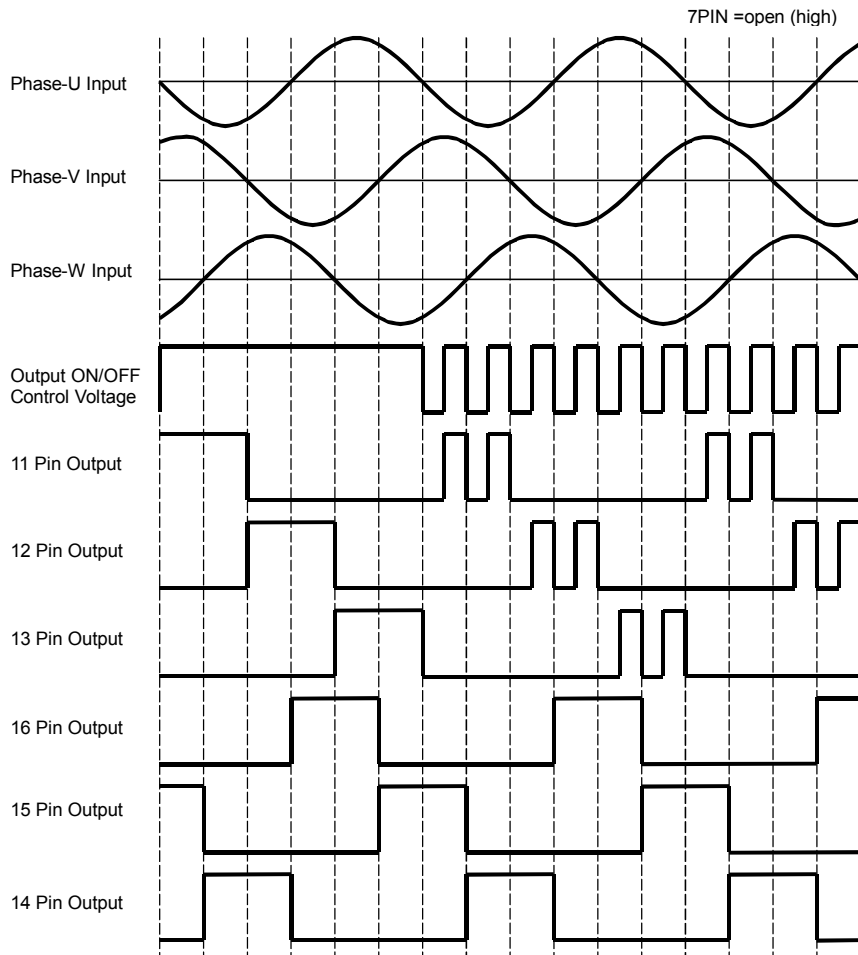

# NJM2624A

## TYPICAL CHARACTERISTICS

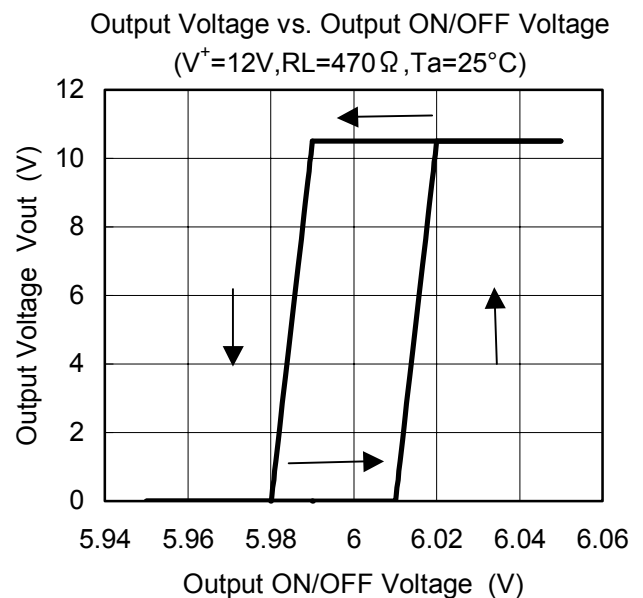
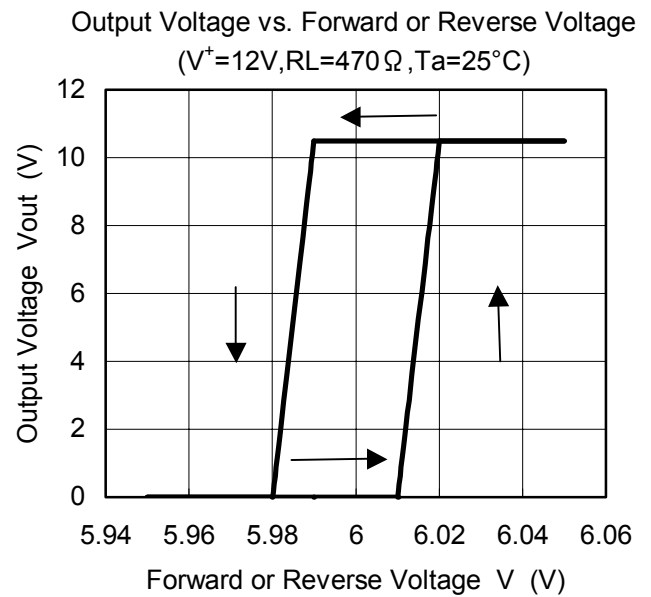
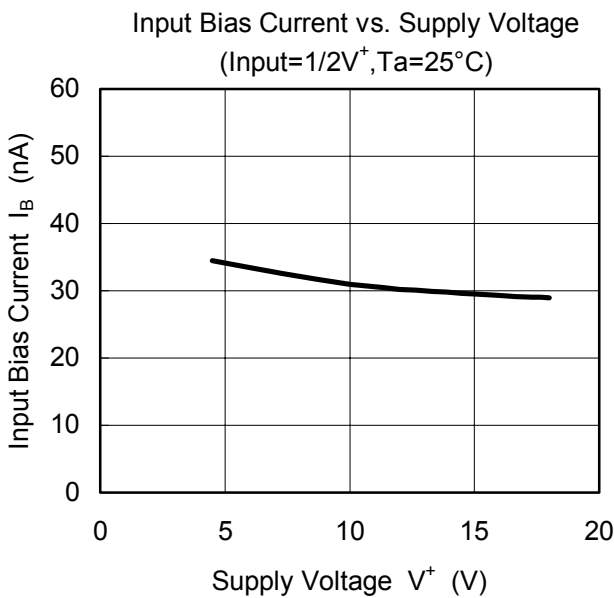
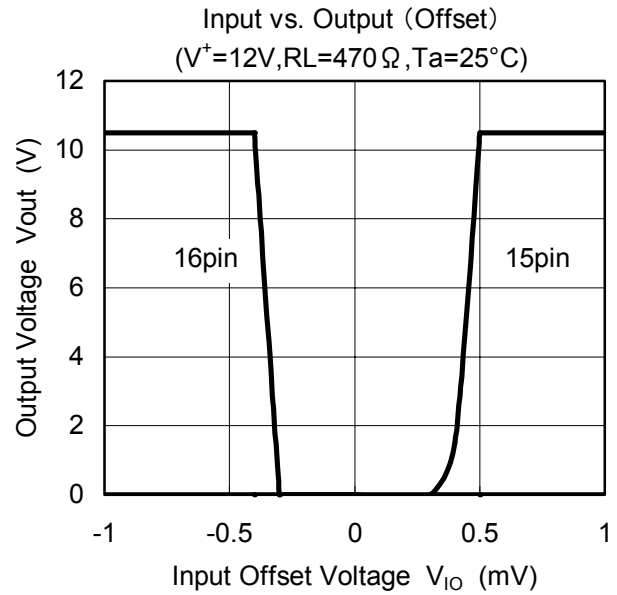
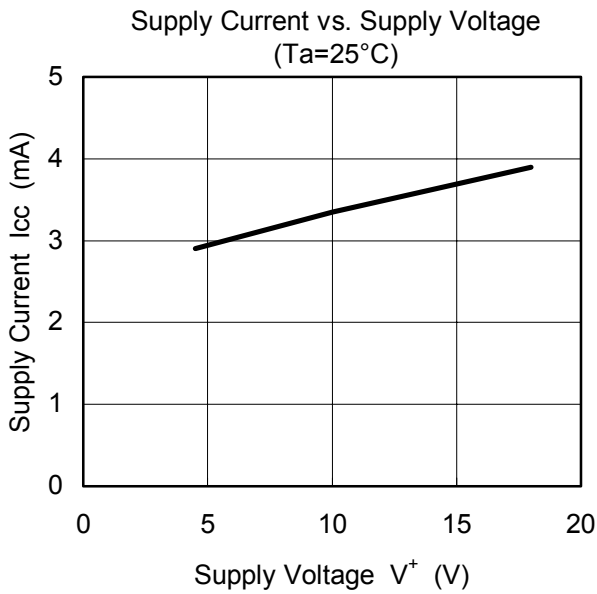



# NJM2624A

## TYPICAL CHARACTERISTICS

Maximum Output Current vs. Temperature  
 ( $V^+ = 12V, R_L = 100\Omega$ )

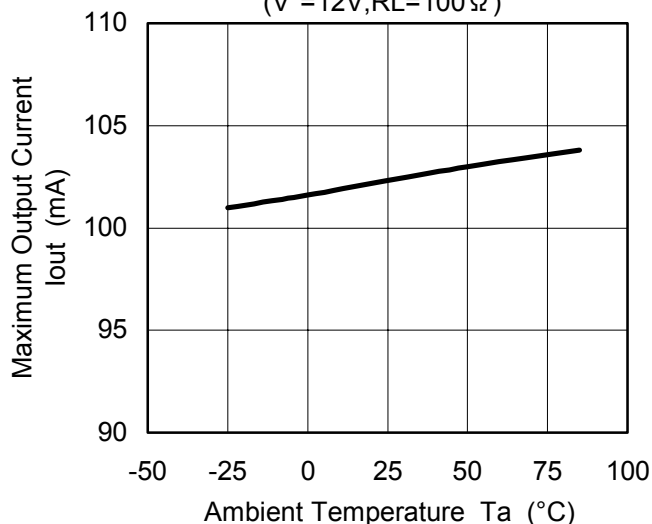

Supply Current vs. Temperature  
 ( $V^+ = 12V, R_L = \infty$ )

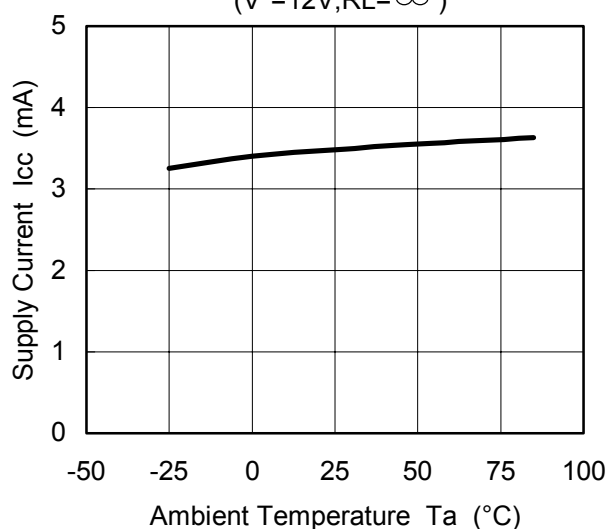

Output Leak Current vs. Temperature  
 ( $V^+ = 12V, R_L = 0\Omega$ )

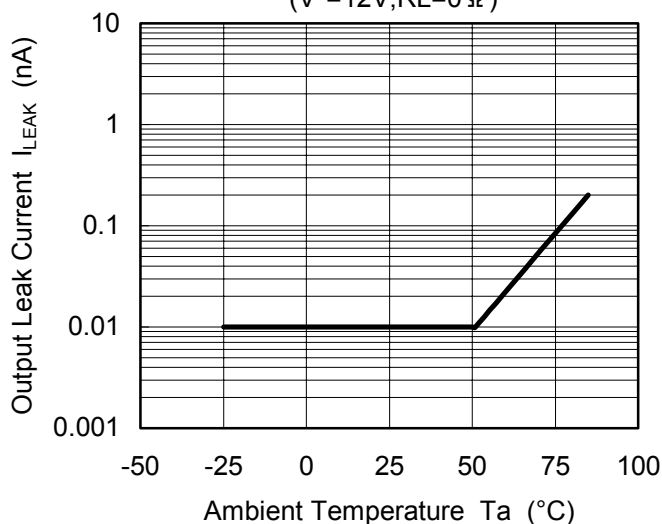

Input Bias Current vs. Temperature  
 ( $V^+ = 12V, Input = 1/2V^+$ )

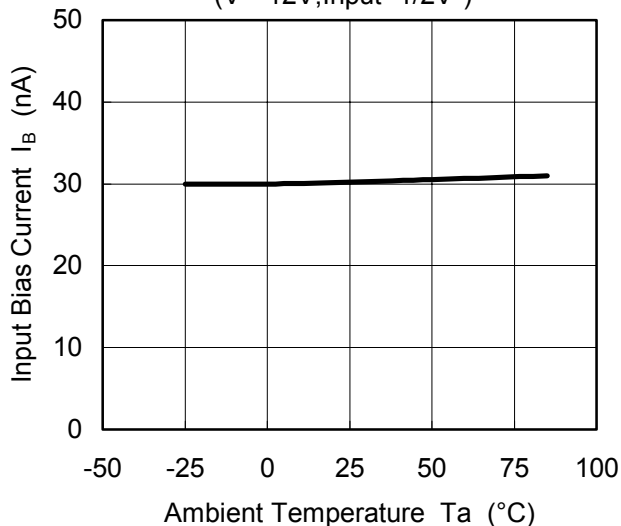

**[CAUTION]**

The specifications on this databook are only given for information, without any guarantee as regards either mistakes or omissions. The application circuits in this databook are described only to show representative usages of the product and not intended for the guarantee or permission of any right including the industrial rights.