

Excellent Integrated System Limited

Stocking Distributor

Click to view price, real time Inventory, Delivery & Lifecycle Information:

[Phoenix Contact](#)
[1998807](#)

For any questions, you can email us directly:

sales@integrated-circuit.com



Extract from the online catalog

PCV 6-16/ 4-G1-10,16

Order No.: 1998807

The figure shows a 5-pos. version of the product



<http://eshop.phoenixcontact.de/phoenix/treeViewClick.do?UID=1998807>

Header, Nominal current: 76 A, Nom. voltage: 1000 V, Pitch: 10.16 mm, Number of positions: 4, Color: green, Assembly: Soldering

Commercial data

EAN	4046356038300
Pack	50 pcs.
Customs tariff	85366990
Weight/Piece	0.017466 KG
Catalog page information	Page 422 (CC-2009)

Product notes

WEEE/RoHS-compliant since:
05/18/2004



<http://www.download.phoenixcontact.com>
Please note that the data given here has been taken from the online catalog. For comprehensive information and data, please refer to the user documentation. The General Terms and Conditions of Use apply to Internet downloads.

Technical data

Dimensions / positions

Length	13.4 mm
Height	34 mm
Pitch	10.16 mm
Dimension a	30.48 mm
Number of positions	4

PCV 6-16/ 4-G1-10,16 Order No.: 1998807

<http://eshop.phoenixcontact.de/phoenix/treeViewClick.do?UID=1998807>

Pin dimensions	1 x 1.2 mm
Pin spacing	10.16 mm
Hole diameter	1.7 mm

Technical data

Insulating material group	I
Rated surge voltage (III/3)	6 kV
Rated surge voltage (III/2)	8 kV
Rated surge voltage (II/2)	8 kV
Rated voltage (III/2)	1000 V
Rated voltage (II/2)	1000 V
Connection in acc. with standard	EN-VDE
Nominal current I_N	76 A (41 A in combination with PC 6 plug)
Nominal voltage U_N	1000 V
Maximum load current	76 A (41 A in combination with PC 6 plug)
Insulating material	PA
Inflammability class acc. to UL 94	V0

Certificates / Approvals



Certification CB, CCA, CUL, SEV, UL

CUL

Nominal voltage U_N	600 V
Nominal current I_N	5 A

UL

Nominal voltage U_N	600 V
Nominal current I_N	5 A

PCV 6-16/ 4-G1-10,16 Order No.: 1998807

<http://eshop.phoenixcontact.de/phoenix/treeViewClick.do?UID=1998807>

Accessories

Item	Designation	Description
------	-------------	-------------

General

1970016	CS-IPC 16/ 6	Coding pin, serves to ensure correct polarization on the PCB during manual mounting
---------	--------------	---

Plug/Adapter

1600027	CP-HCC 4	Coding profile, Color: red
---------	----------	----------------------------

Diagrams/Drawings

Drilling plan/solder pad geometry

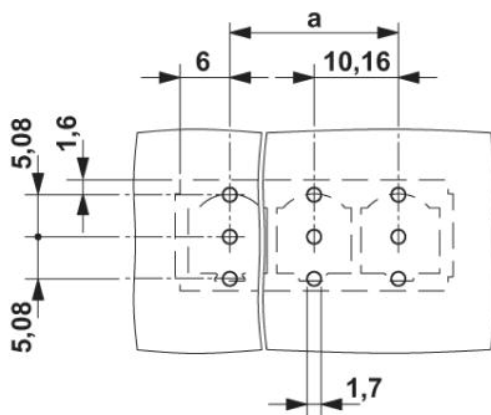

Diagram

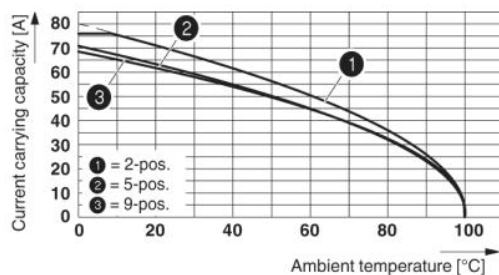

PCV 6-16/ 4-G1-10,16 Order No.: 1998807

<http://eshop.phoenixcontact.de/phoenix/treeViewClick.do?UID=1998807>

Dimensioned drawing

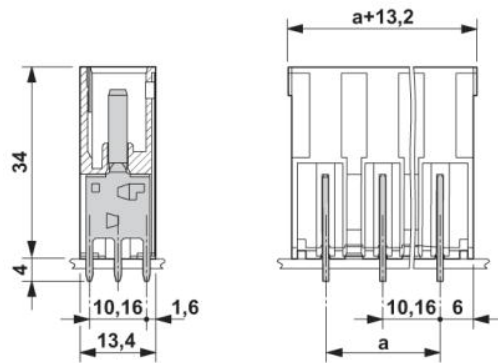

PCV 6-16/ 4-G1-10,16 Order No.: 1998807
<http://eshop.phoenixcontact.de/phoenix/treeViewClick.do?UID=1998807>

Address

PHOENIX CONTACT Inc., USA
586 Fulling Mill Road
Middletown, PA 17057, USA
Phone (800) 888-7388
Fax (717) 944-1625
<http://www.phoenixcon.com>



© 2010 Phoenix Contact
Technical modifications reserved;