

Excellent Integrated System Limited

Stocking Distributor

Click to view price, real time Inventory, Delivery & Lifecycle Information:

[Molex Connector Corporation](#)
[0529910808](#)

For any questions, you can email us directly:

sales@integrated-circuit.com

10 9 8 7 6 5 4 3 2 1

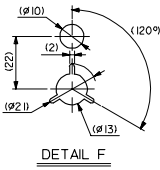
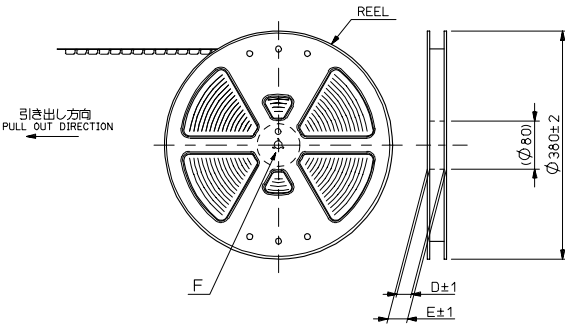

NOTES

1. 製品詳細寸法については図面 SD-52991-004 を参照下さい。
RE: DETAILED DIMENSION, SEE SD-52991-004

2. 梱包数量: 3000個/リール
NUMBER OF CONNECTORS: 3000PCS/REEL

3. リードテープ長さ LEAD TAPE LENGTH

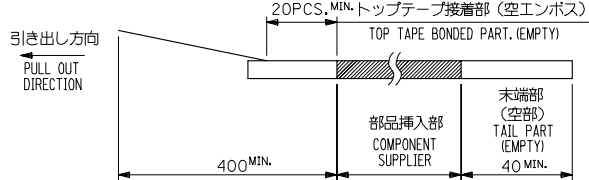

4. トップテープの剥離強度: 0.1N~1.3N (10gf~130gf) (剥離方向は下図参照)
尚、本規格値は出荷時に適用。(但し、輸送時に剥離が発生しないこと。)

PEELING FORCE OF TOP TAPE: 0.1N~1.3N (10gf~130gf)

(PEELING DIRECTION AS SHOWN IN FOLLOWING FIG.)

THIS REQUIREMENT SHOULD BE APPLIED AT SHIPMENT.

PEEL OFF SHOULD NOT BE ALLOWED, DURING TRANSPORTATION.

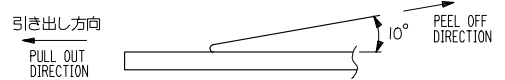

5. 材料 (MATERIAL)

キャリアテープ (CARRIER TAPE): ポリプロピレン (POLYPROPYLENE)

トップテープ (TOP TAPE): PET, PE, PEF

リール (REEL): ポリスチレン (PS) <リサイクル材を含む>

POLYSTYRENE (PS) <RECYCLE MATERIAL CONTAINED>

52991-***8 MODEL NO.

REVISED EC NO: J2006-0604 DRAWN BY: DRUMNALDA CHKD BY: CHIKDKIYODA APPR. BY: APPERNIKITA	DESCRIPTION 2005/08/31 2005/09/01 2005/09/09	GENERAL TOLERANCES (UNLESS SPECIFIED)		DIMENSION STYLE MM ONLY	SCALE ---	DESIGN UNITS METRIC	THIRD ANGLE PROJECTION	
		10 UNDER ±0.2	10 OVER 30 UNDER ±0.25	DRAWN BY T. NIITSU	DATE '95/10/17	TITLE 0.5 B/B CONN REC HSG ASSY EMBSTP PKG -LEAD FREE-		
		30 OVER ±0.3	ANGULAR ±3 °	CHECKED BY T. ITO	DATE '01/01/31	MOLEX INCORPORATED		
		DRAFT WHERE APPLICABLE MUST REMAIN WITHIN DIMENSIONS		APPROVED BY M. FUKUSHIMA	DATE '01/01/31	MATERIAL NO. SEE CHART	DOCUMENT NO. SD-52991-005	SHEET NO. 1 OF 6
REV	SIZE A3	THIS DRAWING CONTAINS INFORMATION THAT IS PROPRIETARY TO MOLEX INCORPORATED AND SHOULD NOT BE USED WITHOUT WRITTEN PERMISSION						

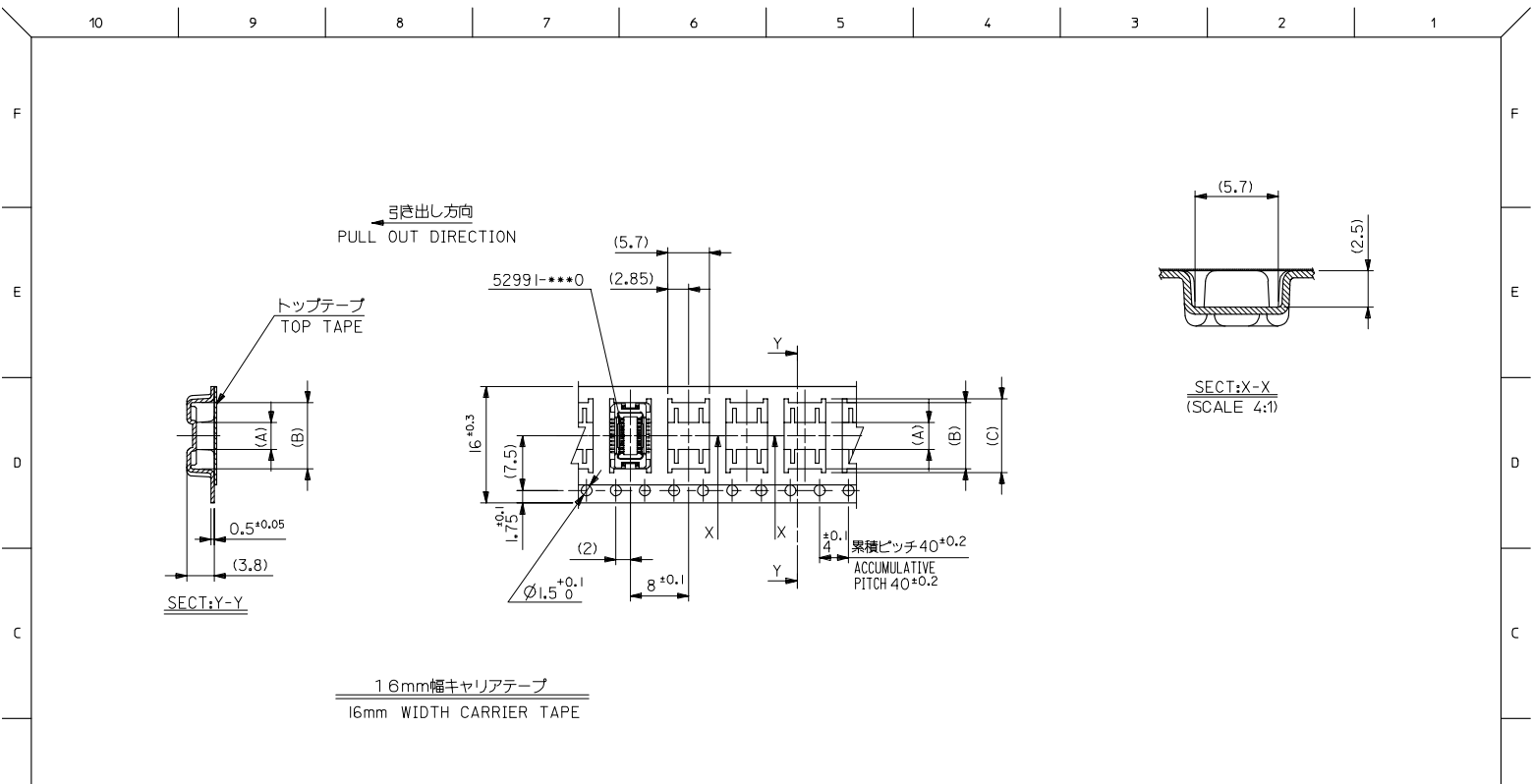

REVISED	EC NO: J2006-0604	2005/08/31	DRYNNALDA	2005/09/01	CHKDKIYODA	2005/09/09	APPERNIKITA	DESCRIPTION	52991-***8	MODEL NO.	16	21.4	17.4	10.1	9.1	3.7	52991-0208	20									
D								GENERAL TOLERANCES (UNLESS SPECIFIED)	キャリアテープ幅 CARRIER TAPE WIDTH	E	D	(C)	(B)	(A)	MATERIAL NO.	種数 CKT.											
								10 UNDER ±---	DIMENSION STYLE	MM ONLY	SCALE	---	DESIGN UNITS	METRIC	THIRD ANGLE PROJECTION												
								10 OVER 30 UNDER ±---	DRAWN BY	T.NIITSU	DATE	'95/10/17	TITLE	0.5 B/B CONN REC HSG ASSY EMBSTP PKG -LEAD FREE-													
								30 OVER ±---	CHECKED BY	T.ITO	DATE	'01/01/31	APPROVED BY	M.FUKUSHIMA	DATE	'01/01/31	MOLEX INCORPORATED										
								ANGULAR ±---	MATERIAL NO.	SEE CHART	DOCUMENT NO.	SD-52991-005	SHEET NO.	2 OF 6													
								DRAFT WHERE APPLICABLE MUST REMAIN WITHIN DIMENSIONS	SIZE	A3	THIS DRAWING CONTAINS INFORMATION THAT IS PROPRIETARY TO MOLEX INCORPORATED AND SHOULD NOT BE USED WITHOUT WRITTEN PERMISSION																

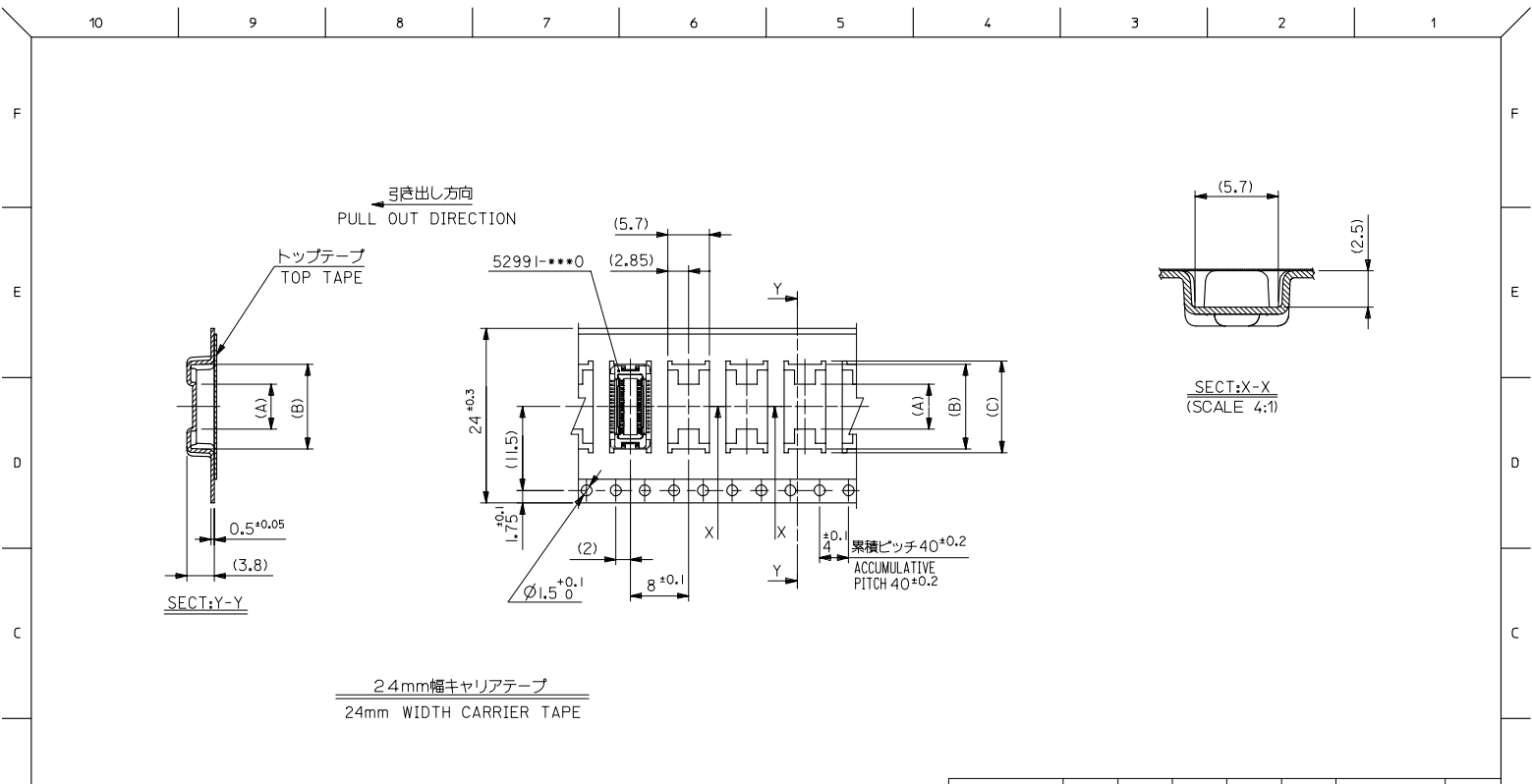

24mm幅キャリアテープ
24mm WIDTH CARRIER TAPE

REVISED	EC NO. J2006-0604	2005/08/31	DRYUMALDA	2005/09/01	CHKDK/TOYODA	2005/09/09	APPER/NIKITA	DESCRIPTION	52991-***8	MODEL NO.	24	29.4	25.4	15.1	14.1	7.4	52991-0408	40	
D								GENERAL TOLERANCES (UNLESS SPECIFIED)	10 UNDER	±---	10 OVER	30 UNDER	±---	30 OVER	±---	ANGULAR	±---	DRAFT WHERE APPLICABLE MUST REMAIN WITHIN DIMENSIONS	THIS DRAWING CONTAINS INFORMATION THAT IS PROPRIETARY TO MOLEX INCORPORATED AND SHOULD NOT BE USED WITHOUT WRITTEN PERMISSION
										DIMENSION STYLE		SCALE		DESIGN UNITS		THIRD ANGLE PROJECTION			
										MM ONLY		---		METRIC					
										DRAWN BY		DATE		TITLE					
										S. AIHARA		'96/04/01		0.5 B/B CONN REC HSG ASSY EMBSTP PKG -LEAD FREE-					
										CHECKED BY		DATE		MOLEX INCORPORATED					
										T. ITO		'01/01/31							
										APPROVED BY		DATE							
										M. FUKUSHIMA		'01/01/31							
										MATERIAL NO.		DOCUMENT NO.		SHEET NO.					
										SEE CHART		SD-52991-005		3 OF 6					

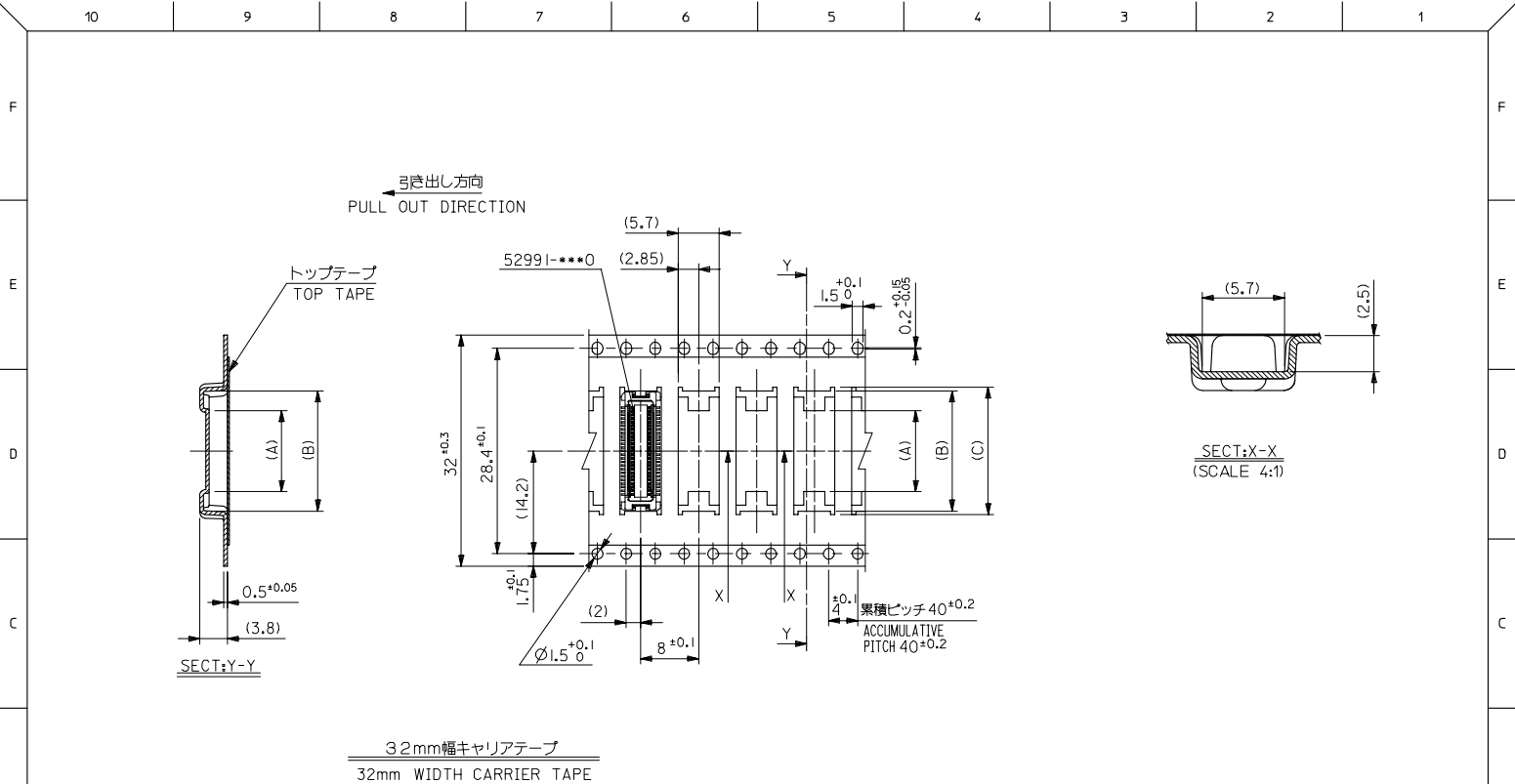

32mm 幅キャリアテープ
32mm WIDTH CARRIER TAPE

REVISED	EC NO. J2006-0604	2005/08/31	DRYUMNAILDA	2005/09/01	CHKDKIYODA	2005/09/01	APPR.NIKITA	2005/09/09	DESCRIPTION	52991-***8	MODEL NO.	32	37.4	33.4	17.6	16.6	11.2	52991-0508	50	種数				
GENERAL TOLERANCES (UNLESS SPECIFIED)										DIMENSION STYLE		SCALE	DESIGN UNITS		THIRD ANGLE PROJECTION									
10 UNDER ±---										MM ONLY		---	METRIC											
10 OVER 30 UNDER ±---										DRAWN BY		DATE	TITLE											
30 OVER ±---										T.YASUI		'96/04/15	0.5 B/B CONN REC HSG											
ANGULAR ±---										CHECKED BY		DATE	ASSY EMBSTP PKG											
DRAFT WHERE APPLICABLE MUST REMAIN WITHIN DIMENSIONS										T. ITO		'01/01/31	-LEAD FREE-											
										APPROVED BY		DATE	MOLEX INCORPORATED											
										M.FUKUSHIMA		'01/01/31	MATERIAL NO.		DOCUMENT NO.									
										SEE CHART		SD-52991-005		SHEET NO.										
										A3		THIS DRAWING CONTAINS INFORMATION THAT IS PROPRIETARY TO MOLEX INCORPORATED AND SHOULD NOT BE USED WITHOUT WRITTEN PERMISSION		4 OF 6										

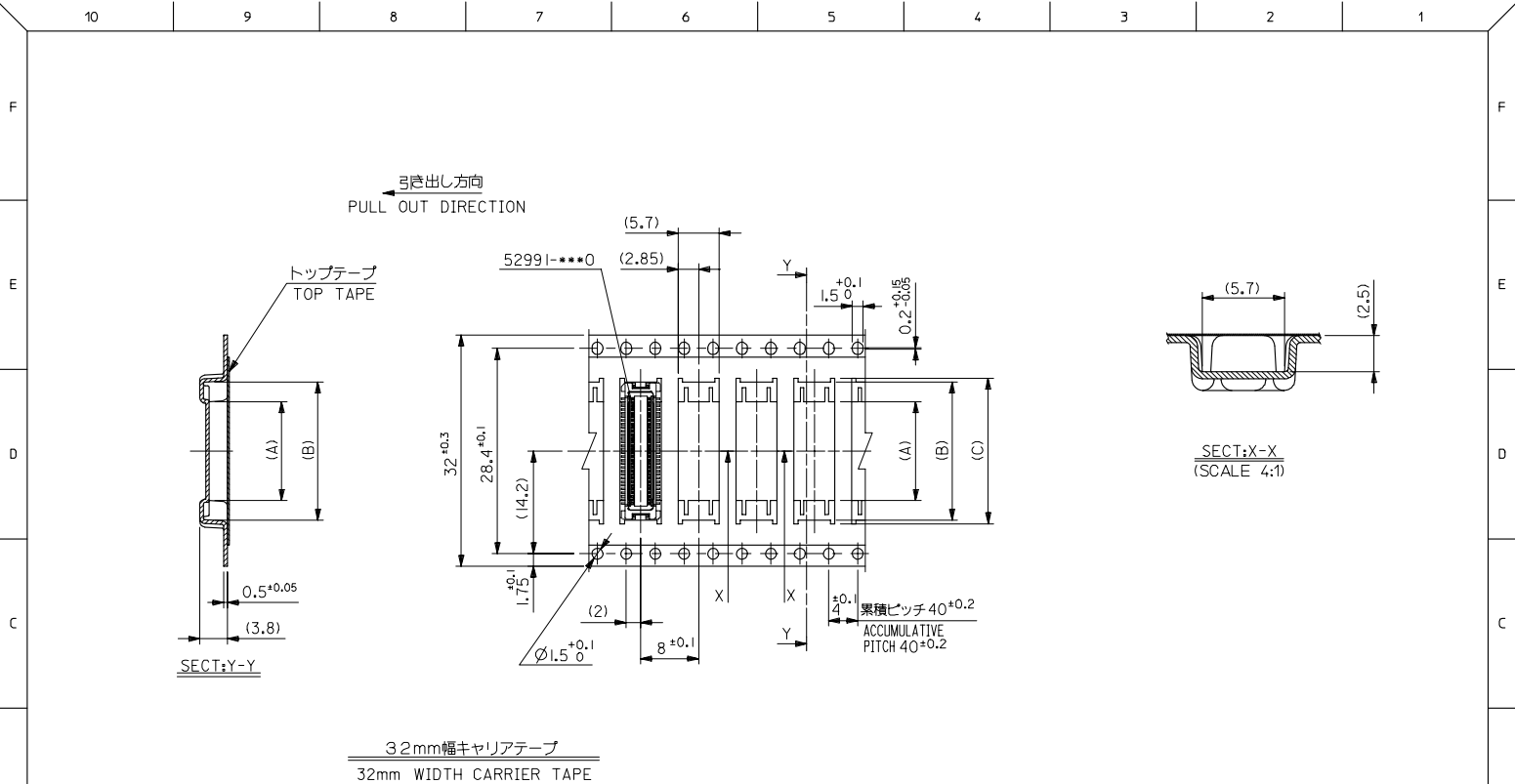

32mm幅キャリアテープ
32mm WIDTH CARRIER TAPE

REVISED	EC NO. J2006-0604	2005/08/31	DRYUMNAILDA	2005/09/01	CHKDKIYODA	2005/09/01	APPERNIKITA	2005/09/09		
DESCRIPTION	52991-***8 MODEL NO.									
GENERAL TOLERANCES (UNLESS SPECIFIED)	DIMENSION STYLE: MM ONLY									
10 UNDER	±---	DRAWN BY: S.AIHARA DATE: '96/04/01								
10 OVER	30 UNDER	±---	CHECKED BY: T.ITO DATE: '01/01/31					TITLE: 0.5 B/B CONN REC HSG ASSY EMBSTP PKG -LEAD FREE-		
30 OVER	±---	APPROVED BY: M.FUKUSHIMA DATE: '01/01/31					MOLEX INCORPORATED			
ANGULAR	±---	MATERIAL NO. SEE CHART							DOCUMENT NO. SD-52991-005	SHEET NO. 5 OF 6
DRAFT WHERE APPLICABLE MUST REMAIN WITHIN DIMENSIONS		SIZE: A3							THIS DRAWING CONTAINS INFORMATION THAT IS PROPRIETARY TO MOLEX INCORPORATED AND SHOULD NOT BE USED WITHOUT WRITTEN PERMISSION	

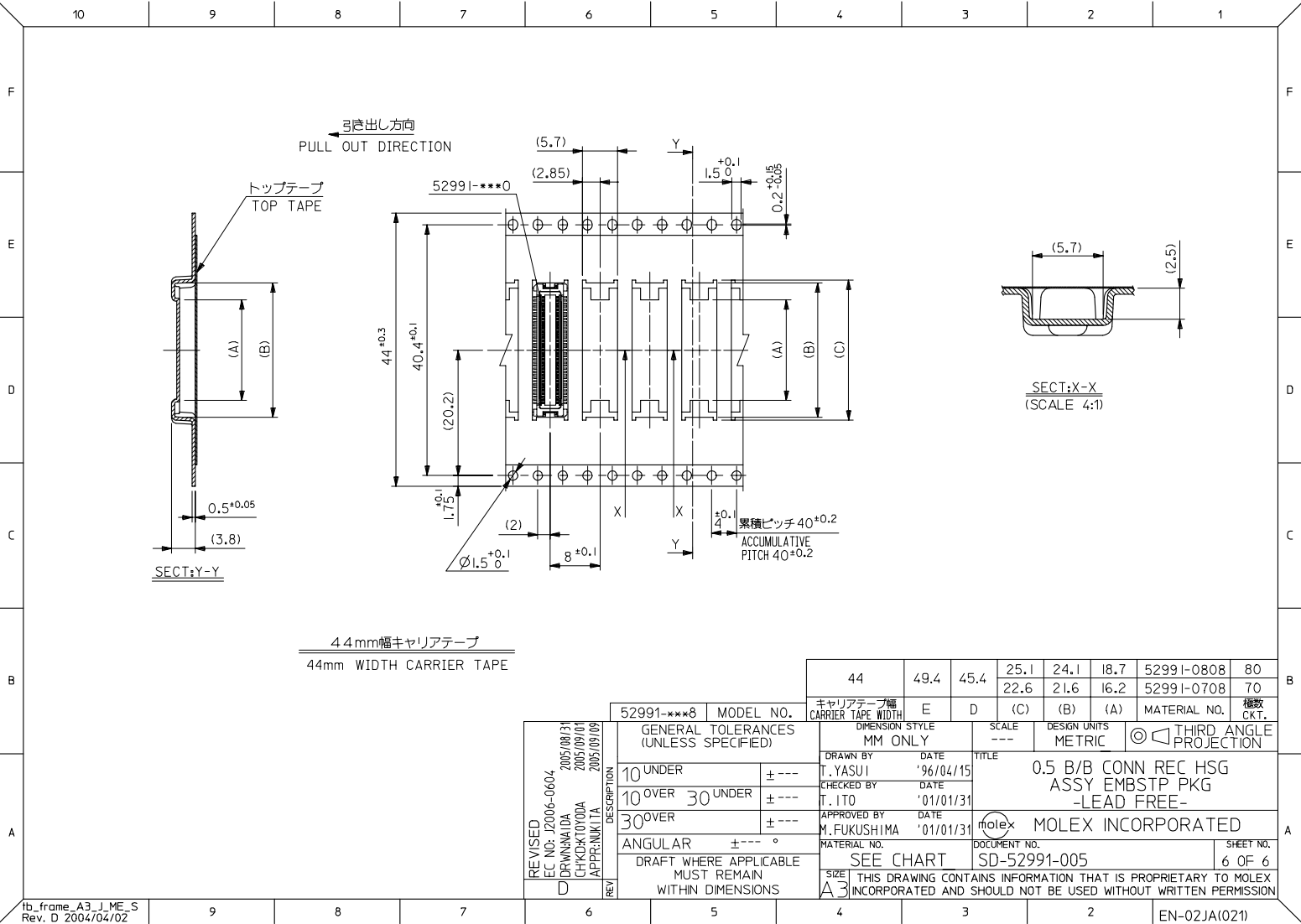

44mm 幅キャリアテープ
44mm WIDTH CARRIER TAPE

REVISED	EC NO: J2006-0604	2005/08/31	DRYNNALDA	2005/09/01	CHKDKIYODA	2005/09/09	APPR.NIKITA	DESCRIPTION	52991-***8	MODEL NO.	44	49.4	45.4	25.1	24.1	18.7	52991-0808	80									
D								GENERAL TOLERANCES (UNLESS SPECIFIED)	キャリアテープ幅 CARRIER TAPE WIDTH	E	D	(C)	(B)	(A)	MATERIAL NO.	種数 CKT.											
								10 UNDER ±---	DIMENSION STYLE	MM ONLY	SCALE	---	DESIGN UNITS	METRIC	THIRD ANGLE PROJECTION												
								10 OVER 30 UNDER ±---	DRAWN BY	T.YASUI	DATE	'96/04/15	TITLE	0.5 B/B CONN REC HSG ASSY EMBSTP PKG -LEAD FREE-													
								30 OVER ±---	CHECKED BY	T. ITO	DATE	'01/01/31	APPROVED BY	M.FUKUSHIMA	DATE	'01/01/31	MOLEX INCORPORATED										
								ANGULAR ±---	MATERIAL NO.	SEE CHART	DOCUMENT NO.	SD-52991-005	SHEET NO.	6 OF 6													
								DRAFT WHERE APPLICABLE MUST REMAIN WITHIN DIMENSIONS	SIZE	A3	THIS DRAWING CONTAINS INFORMATION THAT IS PROPRIETARY TO MOLEX INCORPORATED AND SHOULD NOT BE USED WITHOUT WRITTEN PERMISSION																