

## Excellent Integrated System Limited

Stocking Distributor

Click to view price, real time Inventory, Delivery & Lifecycle Information:

[STMicroelectronics](#)  
[STPS30H100CT](#)

For any questions, you can email us directly:

[sales@integrated-circuit.com](mailto:sales@integrated-circuit.com)



# STPS30H100C

## High voltage power Schottky rectifier

Datasheet – production data

### Features

- Negligible switching losses
- Low leakage current
- Good trade off between leakage current and forward voltage drop
- Low thermal resistance
- Avalanche capability specified

### Description

Dual center tap Schottky rectifier suited for switch mode power supplies and high frequency DC to DC converters.

Packaged in TO-200AB, TO-220AB narrow leads, TO-247, and I<sup>2</sup>PAK this device is intended for use in high frequency inverters.

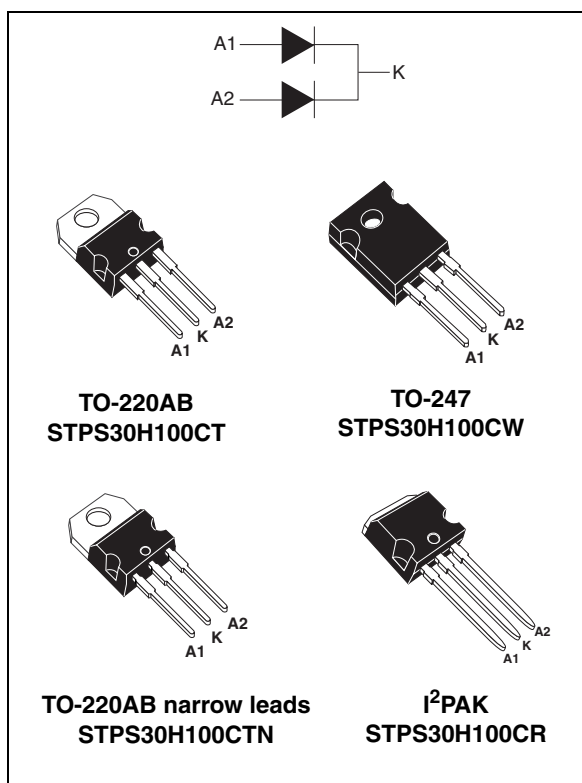

Table 1. Device summary

Symbol	Value
$I_{F(AV)}$	2 x 15 A
$V_{RRM}$	100 V
$T_j$ (max)	175 °C
$V_F$ (max)	0.67 V

# 1 Characteristics

**Table 2. Absolute ratings (limiting values, per diode)**

Symbol	Parameter		Value	Unit	
$V_{RRM}$	Repetitive peak reverse voltage		100	V	
$I_{F(RMS)}$	Forward rms current		30	A	
$I_{F(AV)}$	Average forward current	$T_c = 155\text{ }^\circ\text{C}$	Per diode	15	A
		$\delta = 0.5$	Per device	30	
$I_{FSM}$	Surge non repetitive forward current	$t_p = 10\text{ ms sinusoidal}$	250	A	
$I_{RRM}$	Repetitive peak reverse current	$t_p = 2\text{ }\mu\text{s square, } F = 1\text{ kHz}$	1	A	
$I_{RSM}$	Non repetitive peak reverse current	$t_p = 100\text{ }\mu\text{s square}$	3	A	
$P_{ARM}$	Repetitive peak avalanche power	$t_p = 1\text{ }\mu\text{s } T_j = 25\text{ }^\circ\text{C}$	10800	W	
$T_{stg}$	Storage temperature range		-65 to + 175	$^\circ\text{C}$	
$T_j$	Operating junction temperature range <sup>(1)</sup>		-40 to +175	$^\circ\text{C}$	
dV/dt	Critical rate of rise of reverse voltage		10000	V/ $\mu\text{s}$	

1.  $\frac{dP_{tot}}{dT_j} < \frac{1}{R_{th(j-a)}}$  condition to avoid thermal runaway for a diode on its own heatsink

**Table 3. Thermal resistance**

Symbol	Parameter		Value	Unit
$R_{th(j-c)}$	Junction to case	Per diode	1.6	$^\circ\text{C/W}$
		Total	0.9	
$R_{th(c)}$	Coupling		0.1	

When the diodes 1 and 2 are used simultaneously:

$$\Delta T_j(\text{diode 1}) = P(\text{diode 1}) \times R_{th(j-c)}(\text{Per diode}) + P(\text{diode 2}) \times R_{th(c)}$$

**Table 4. Static electrical characteristics (per diode)**

Symbol	Parameter	Test conditions		Min.	Typ.	Max.	Unit
$I_R^{(1)}$	Reverse leakage current	$T_j = 25\text{ }^\circ\text{C}$	$V_R = V_{RRM}$			5	$\mu\text{A}$
		$T_j = 125\text{ }^\circ\text{C}$			2	6	mA
$V_F^{(2)}$	Forward voltage drop	$T_j = 25\text{ }^\circ\text{C}$	$I_F = 15\text{ A}$			0.80	V
		$T_j = 125\text{ }^\circ\text{C}$			0.64	0.67	
		$T_j = 25\text{ }^\circ\text{C}$	$I_F = 30\text{ A}$			0.93	
		$T_j = 125\text{ }^\circ\text{C}$			0.74	0.8	

1. Pulse test:  $t_p = 5\text{ ms, } \delta < 2\%$

2. Pulse test:  $t_p = 380\text{ }\mu\text{s, } \delta < 2\%$

To evaluate the conduction losses use the following equation:

$$P = 0.54 \times I_{F(AV)} + 0.0086 I_{F(RMS)}^2$$

**STPS30H100C**

**Characteristics**

**Figure 1. Average forward power dissipation versus average forward current (per diode)**

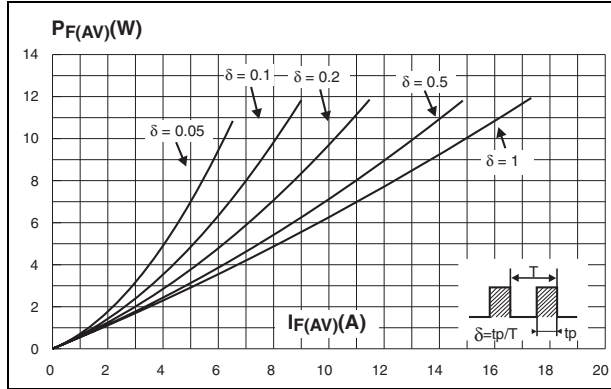

**Figure 2. Average forward current versus ambient temperature ( $\delta = 0.5$ , per diode)**

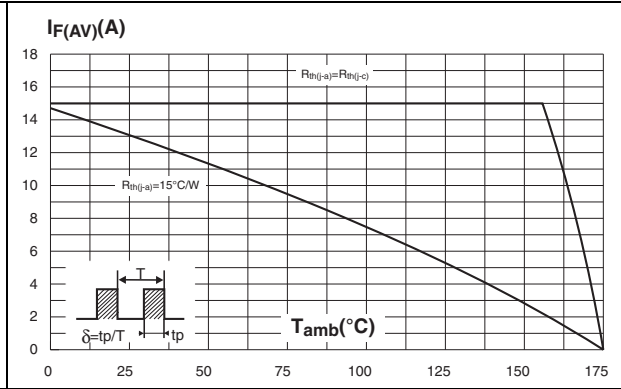

**Figure 3. Normalized avalanche power derating versus pulse duration**

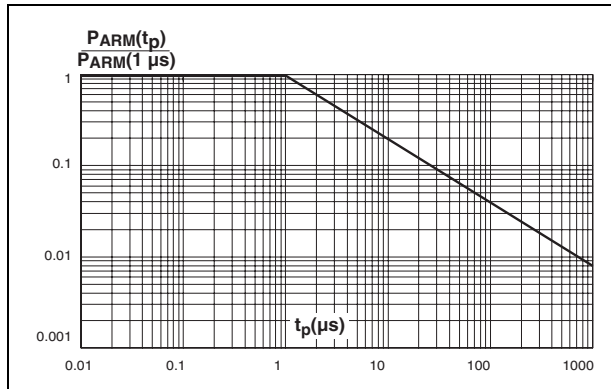

**Figure 4. Normalized avalanche power derating versus junction temperature**

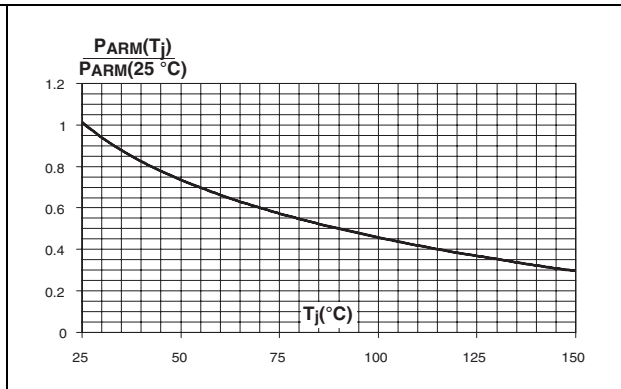

**Figure 5. Non repetitive surge peak forward current versus overload duration (maximum values, per diode)**

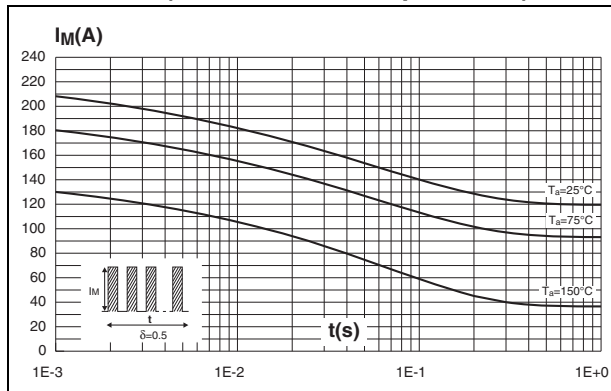

**Figure 6. Relative variation of thermal impedance junction to case versus pulse duration**

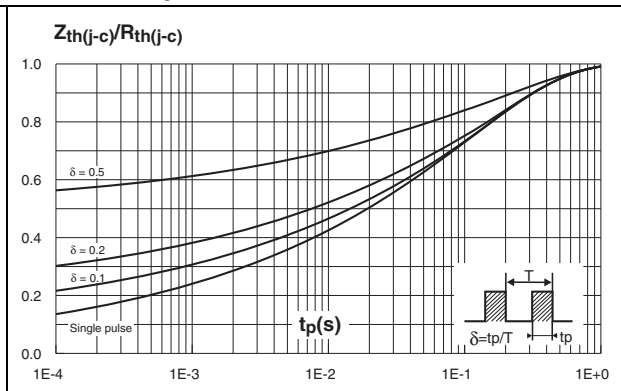

**Characteristics**

**STPS30H100C**

**Figure 7. Reverse leakage current versus reverse voltage applied (typical values, per diode)**

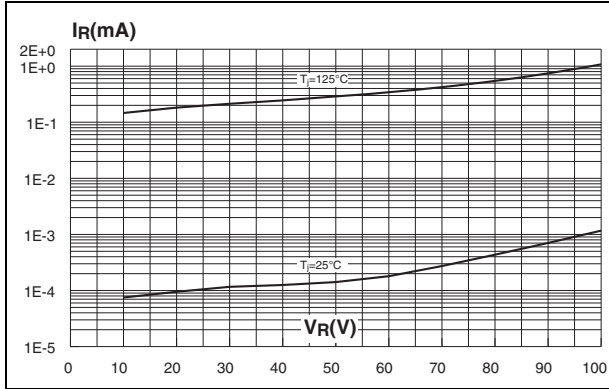

**Figure 8. Junction capacitance versus reverse voltage applied (typical values, per diode)**

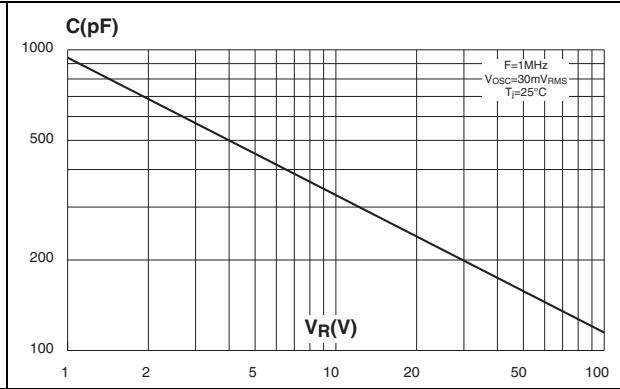

**Figure 9. Forward voltage drop versus forward current (maximum values, per diode)**

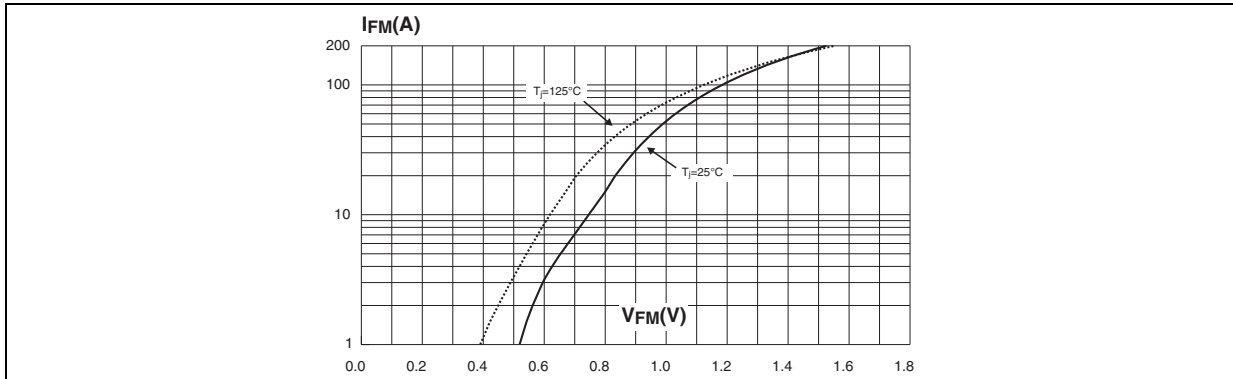

STPS30H100C

Package information

## 2 Package information

- Epoxy meets UL94, V0
- Cooling method: by conduction (C)
- Recommended torque value: 0.4 to 0.6 N·m (TO-220AB), 0.55 N·m (TO-247)
- Maximum torque value: 1.0 N·m (TO-247)

In order to meet environmental requirements, ST offers these devices in different grades of ECOPACK® packages, depending on their level of environmental compliance. ECOPACK® specifications, grade definitions and product status are available at: [www.st.com](http://www.st.com). ECOPACK® is an ST trademark.

Table 5. TO-247 dimensions

Ref.	Dimensions					
	Millimeters			Inches		
	Min.	Typ.	Max.	Min.	Typ.	Max.
A	4.85		5.15	0.191		0.203
A1	2.20		2.60	0.086		0.102
b	1.00		1.40	0.039		0.055
b1	2.00		2.40	0.078		0.094
b2	3.00		3.40	0.118		0.133
c	0.40		0.80	0.015		0.031
D <sup>(1)</sup>	19.85		20.15	0.781		0.793
E	15.45		15.75	0.608		0.620
e	5.30	5.45	5.60	0.209	0.215	0.220
L	14.20		14.80	0.559		0.582
L1	3.70		4.30	0.145		0.169
L2	18.50 typ.			0.728 typ.		
∅P <sup>(2)</sup>	3.55		3.65	0.139		0.143
∅R	4.50		5.50	0.177		0.217
S	5.30	5.50	5.70	0.209	0.216	0.224

1. Dimension D plus gate protrusion does not exceed 20.5 mm
2. Resin thickness around the mounting hole is not less than 0.9 mm

Package information

STPS30H100C

Table 6. TO-220AB narrow leads dimensions

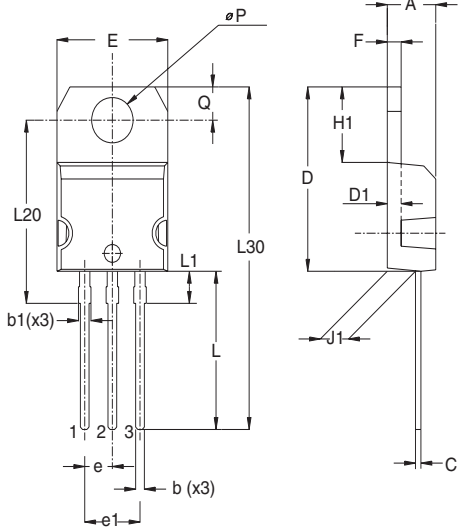

Ref.	Dimensions					
	Millimeters			Inches		
	Min.	Typ.	Max.	Min.	Typ.	Max.
A	4.40		4.60	0.17		0.18
b	0.61		0.88	0.024		0.034
b1	0.95		1.20	0.037		0.047
c	0.48		0.70	0.019		0.027
D	15.25		15.75	0.60		0.62
D1	1.27			0.05		
E	10.00		10.40	0.39		0.41
e	2.40		2.70	0.094		0.106
e1	4.95		5.15	0.19		0.20
F	1.23		1.32	0.048		0.052
H1	6.20		6.60	0.24		0.26
J1	2.40		2.72	0.095		0.107
L	13.00		14.00	0.51		0.55
L1	2.60		2.90	0.102		0.114
L20	15.40			0.61		
L30	28.90			1.14		
∅P	3.75		3.85	0.147		0.151
Q	2.65		2.95	0.104		0.116

Note: The legs of the TO-220 narrow leads must NOT be bent when mounted on the PCB.

**STPS30H100C**

**Package information**

**Table 7. TO-220AB dimensions**

Ref.	Dimensions			
	Millimeters		Inches	
	Min.	Max.	Min.	Max.
A	4.40	4.60	0.173	0.181
C	1.23	1.32	0.048	0.051
D	2.40	2.72	0.094	0.107
E	0.49	0.70	0.019	0.027
F	0.61	0.88	0.024	0.034
F1	1.14	1.70	0.044	0.066
F2	1.14	1.70	0.044	0.066
G	4.95	5.15	0.194	0.202
G1	2.40	2.70	0.094	0.106
H2	10	10.40	0.393	0.409
L2	16.4 typ.		0.645 typ.	
L4	13	14	0.511	0.551
L5	2.65	2.95	0.104	0.116
L6	15.25	15.75	0.600	0.620
L7	6.20	6.60	0.244	0.259
L9	3.50	3.93	0.137	0.154
M	2.6 typ.		0.102 typ.	
Diam.	3.75	3.85	0.147	0.151

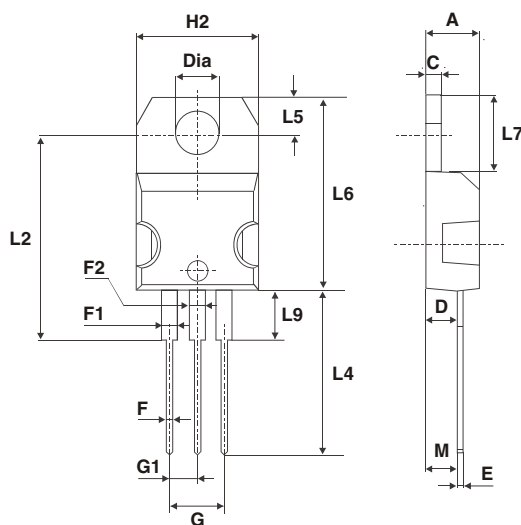



Package information

STPS30H100C

Table 8. I<sup>2</sup>PAK dimensions

Ref.	Dimensions			
	Millimeters		Inches	
	Min.	Max.	Min.	Max.
A	4.40	4.60	0.173	0.181
A1	2.40	2.72	0.094	0.107
b	0.61	0.88	0.024	0.035
b1	1.14	1.70	0.044	0.067
c	0.49	0.70	0.019	0.028
c2	1.23	1.32	0.048	0.052
D	8.95	9.35	0.352	0.368
e	2.40	2.70	0.094	0.106
e1	4.95	5.15	0.195	0.203
E	10	10.40	0.394	0.409
L	13	14	0.512	0.551
L1	3.50	3.93	0.138	0.155
L2	1.27	1.40	0.050	0.055

STPS30H100C

Ordering information

### 3 Ordering information

Table 9. Ordering information

Order code	Marking	Package	Weight	Base qty	Delivery mode
STPS30H100CW	STPS30H100CW	TO-247	4.36 g	30	Tube
STPS30H100CT	STPS30H100CT	TO-220AB	2.20 g	50	Tube
STPS30H100CR	STPS30H100CR	I <sup>2</sup> PAK	1.49 g	50	Tube
STPS30H100CTN	PS30H100CTN	TO-220AB narrow leads	1.9 g	50	Tube

### 4 Revision history

Table 10. Revision history

Date	Revision	Changes
Jul-2003	5E	Previous release.
30-Mar-2011	6	Added I <sup>2</sup> PAK package.
15-Sep-2011	7	Added TO-220AB narrow leads package. Updated <a href="#">Table 5</a> .
21-June-2012	8	Added minimum value for T <sub>j</sub> in <a href="#">Table 2</a> .

## STPS30H100C

---

### Please Read Carefully:

Information in this document is provided solely in connection with ST products. STMicroelectronics NV and its subsidiaries ("ST") reserve the right to make changes, corrections, modifications or improvements, to this document, and the products and services described herein at any time, without notice.

All ST products are sold pursuant to ST's terms and conditions of sale.

Purchasers are solely responsible for the choice, selection and use of the ST products and services described herein, and ST assumes no liability whatsoever relating to the choice, selection or use of the ST products and services described herein.

No license, express or implied, by estoppel or otherwise, to any intellectual property rights is granted under this document. If any part of this document refers to any third party products or services it shall not be deemed a license grant by ST for the use of such third party products or services, or any intellectual property contained therein or considered as a warranty covering the use in any manner whatsoever of such third party products or services or any intellectual property contained therein.

**UNLESS OTHERWISE SET FORTH IN ST'S TERMS AND CONDITIONS OF SALE ST DISCLAIMS ANY EXPRESS OR IMPLIED WARRANTY WITH RESPECT TO THE USE AND/OR SALE OF ST PRODUCTS INCLUDING WITHOUT LIMITATION IMPLIED WARRANTIES OF MERCHANTABILITY, FITNESS FOR A PARTICULAR PURPOSE (AND THEIR EQUIVALENTS UNDER THE LAWS OF ANY JURISDICTION), OR INFRINGEMENT OF ANY PATENT, COPYRIGHT OR OTHER INTELLECTUAL PROPERTY RIGHT.**

**UNLESS EXPRESSLY APPROVED IN WRITING BY TWO AUTHORIZED ST REPRESENTATIVES, ST PRODUCTS ARE NOT RECOMMENDED, AUTHORIZED OR WARRANTED FOR USE IN MILITARY, AIR CRAFT, SPACE, LIFE SAVING, OR LIFE SUSTAINING APPLICATIONS, NOR IN PRODUCTS OR SYSTEMS WHERE FAILURE OR MALFUNCTION MAY RESULT IN PERSONAL INJURY, DEATH, OR SEVERE PROPERTY OR ENVIRONMENTAL DAMAGE. ST PRODUCTS WHICH ARE NOT SPECIFIED AS "AUTOMOTIVE GRADE" MAY ONLY BE USED IN AUTOMOTIVE APPLICATIONS AT USER'S OWN RISK.**

Resale of ST products with provisions different from the statements and/or technical features set forth in this document shall immediately void any warranty granted by ST for the ST product or service described herein and shall not create or extend in any manner whatsoever, any liability of ST.

ST and the ST logo are trademarks or registered trademarks of ST in various countries.

Information in this document supersedes and replaces all information previously supplied.

The ST logo is a registered trademark of STMicroelectronics. All other names are the property of their respective owners.

© 2012 STMicroelectronics - All rights reserved

STMicroelectronics group of companies

Australia - Belgium - Brazil - Canada - China - Czech Republic - Finland - France - Germany - Hong Kong - India - Israel - Italy - Japan - Malaysia - Malta - Morocco - Philippines - Singapore - Spain - Sweden - Switzerland - United Kingdom - United States of America

[www.st.com](http://www.st.com)