

Excellent Integrated System Limited

Stocking Distributor

Click to view price, real time Inventory, Delivery & Lifecycle Information:

[STMicroelectronics](#)

[STTA406](#)

For any questions, you can email us directly:

sales@integrated-circuit.com



STTA406

TURBOSWITCH™ ULTRA-FAST HIGH VOLTAGE DIODE

MAJOR PRODUCT CHARACTERISTICS

I_p	4 A
V_{RRM}	600 V
t_{rr} (typ.)	25 ns
V_F (max)	1.5 V

FEATURES AND BENEFITS

- SPECIFIC TO FREEWHEEL MODE OPERATIONS: FREEWHEEL OR BOOSTER DIODE
- ULTRA-FAST, AND SOFT RECOVERY
- VERY LOW OVERALL POWER LOSSES IN BOTH THE DIODE AND THE COMPANION TRANSISTOR
- HIGH FREQUENCY OPERATIONS

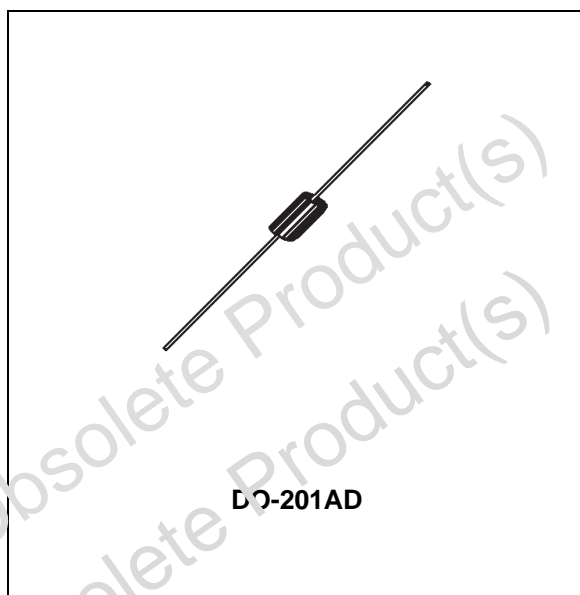

DESCRIPTION

The TURBOSWITCH is a very high performance series of ultra-fast high voltage power diodes.

TURBOSWITCH family, drastically cuts losses in both the diode and the associated switching IGBT or MOSFET in all freewheel mode operations and

is particularly suitable and efficient in motor control freewheel applications and in booster diode applications in power factor control circuitries. Packaged in DO-201AD this 600V device is particularly intended for use on 240V domestic mains.

ABSOLUTE RATINGS (limiting values)

Symbol	Parameter		VALUE	Unit
V _{RRM}	Repetitive peak reverse voltage		600	V
I _p	Peak forward current (1)	T _{amb} = 65°C δ = 0.5	4	A
I _{FRM}	Repetitive peak forward current	t _p = 5μs F = 5kHz square	30	A
I _{FSM}	Surge non repetitive forward current	t _p = 10 ms sinusoidal	80	A
T _j	Maximum operating junction temperature		125	°C
T _{stg}	Storage temperature range		- 40 to 150	°C

(1) square waveform and on infinite heatsink

TURBOSWITCH is a trademark of STMicroelectronics

STTA406
THERMAL DATA

Symbol	Parameter	Max.	Unit
$R_{th(j-l)}$	Junction to lead L lead = 10mm	20	°C/W
$R_{th(j-a)}$	Junction to ambient on printed circuit L lead = 10mm	75	°C/W

STATIC ELECTRICAL CHARACTERISTICS

Symbol	Parameter	Test conditions	Typ.	Max.	Unit
V_F **	Forward voltage drop	$I_F = 4\text{ A}$ $T_j = 25^\circ\text{C}$ $T_j = 125^\circ\text{C}$	1.25	1.75 1.5	V V
I_R *	Reverse leakage current	$V_R = 0.8 V_{RRM}$ $T_j = 25^\circ\text{C}$ $T_j = 125^\circ\text{C}$	0.75	50 2	μA mA
V_{to}	Threshold voltage	$I_p < 3 \cdot I_{F(AV)}$ $T_j = 125^\circ\text{C}$		1.15	V
R_d	Dynamic resistance			85	m Ω

 Test pulse : * $t_p = 380\ \mu\text{s}$, $\delta < 2\%$

 ** $t_p = 5\ \text{ms}$, $\delta < 2\%$

To evaluate the maximum conduction losses use the following equation :

$$P = V_{to} \times I_{F(AV)} + R_d \times I_F^2_{(RMS)}$$

DYNAMIC ELECTRICAL CHARACTERISTICS
TURN-OFF SWITCHING

Symbol	Parameter	Test conditions	Typ.	Max.	Unit
t_{rr}	Reverse recovery time	$I_F = 0.5\text{ A}$ $I_R = 1\text{ A}$ $I_{rr} = 0.25\text{ A}$	25		ns
		$I_F = 1\text{ A}$ $di/dt = -50\text{ A}/\mu\text{s}$ $V_R = 30\text{ V}$		55	ns

TURN-ON SWITCHING

Symbol	Parameter	Test conditions	Typ.	Max.	Unit
t_{fr}	Forward recovery time	$I_F = 4\text{ A}$ $di/dt = 100\text{ A}/\mu\text{s}$ Measured at $1.1 \times V_F$ max.		200	ns
V_{FP}	Peak forward voltage	$T_j = 25^\circ\text{C}$		20	V

STTA406

Fig. 1: Power dissipation versus average forward current.

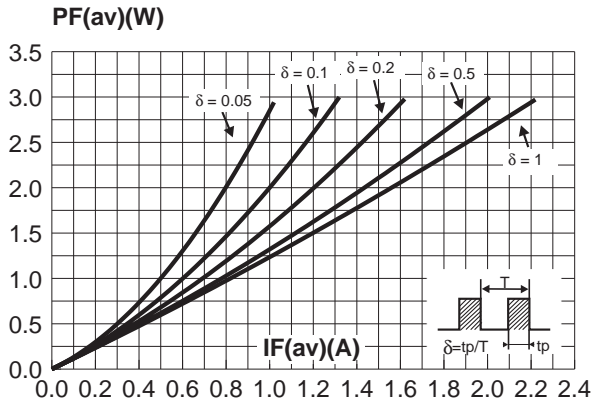

Fig. 2: Average forward current versus ambient temperature (delta=0.5).

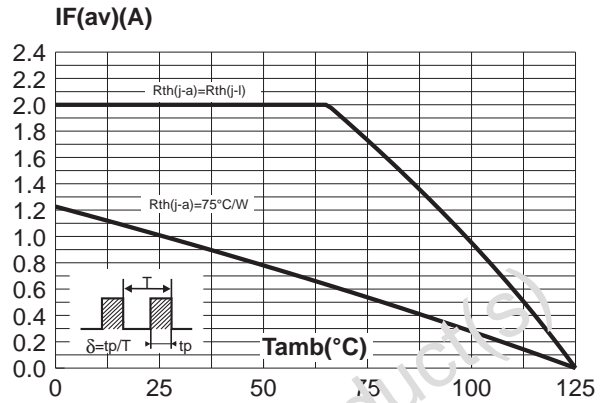

Fig. 3: Relative variation of thermal impedance junction to ambient versus pulse duration (epoxy printed circuit board, e(Cu)=35um, recommended pad layout).

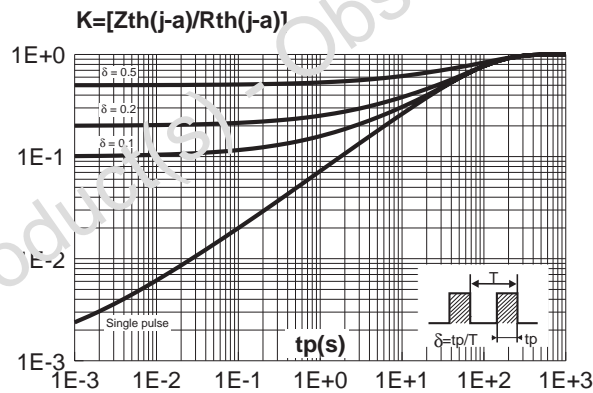

Fig. 4-2 : Forward voltage drop versus forward current (high level).

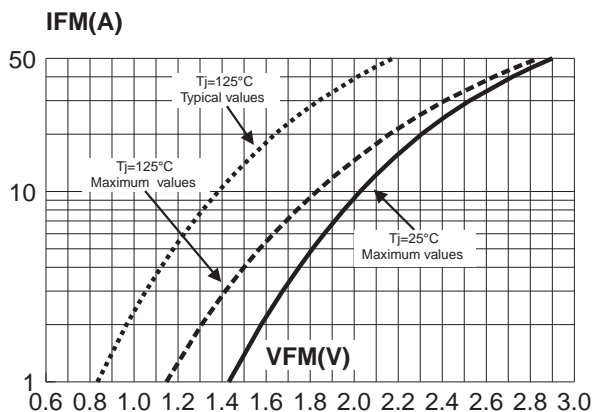
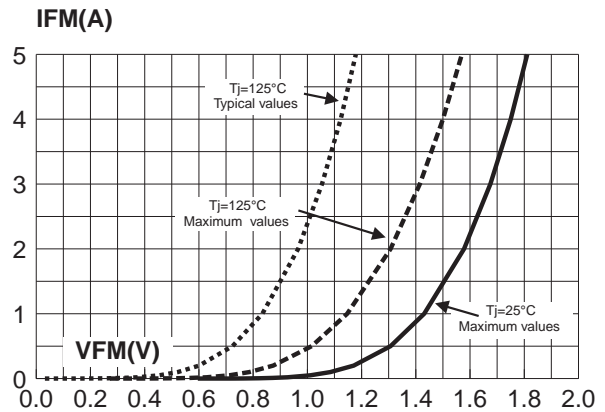

Fig. 4-1: Forward voltage drop versus forward current (low level).



STTA406

Fig 5 : Reverse recovery time versus dI_F/dt .

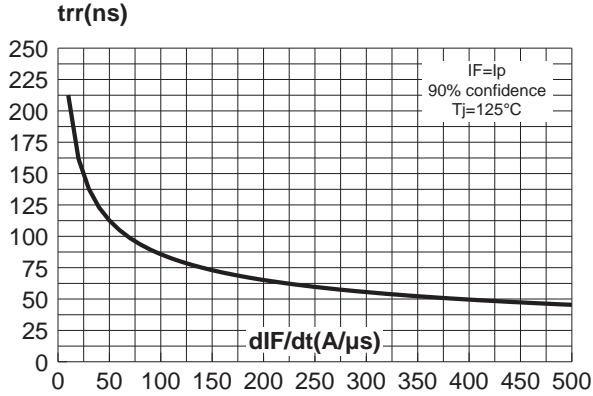

Fig. 6: Reverse recovery current versus dI_F/dt .

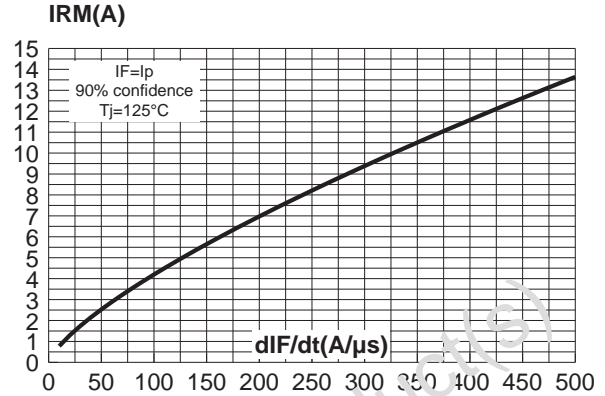

Fig. 7: Transient peak forward voltage versus dI_F/dt .

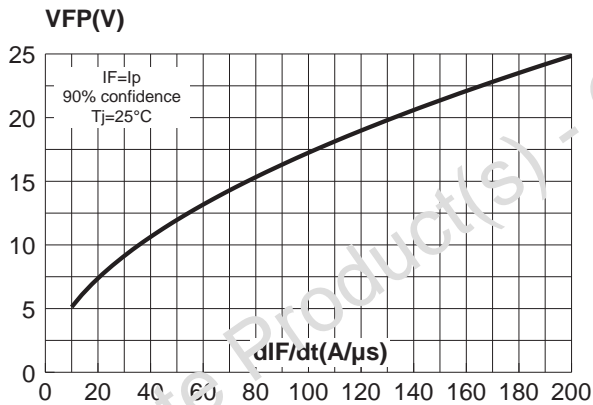

Fig. 9: Junction capacitance versus reverse voltage applied (typical values).

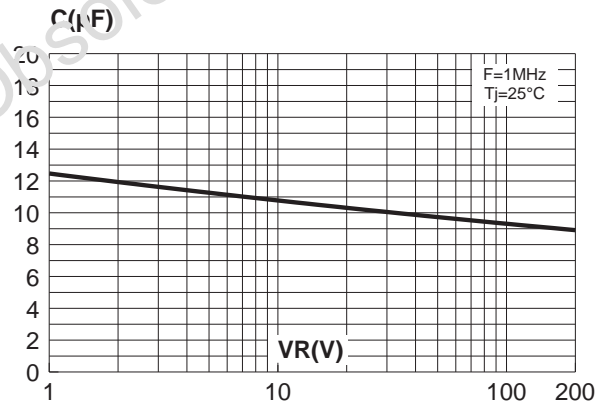
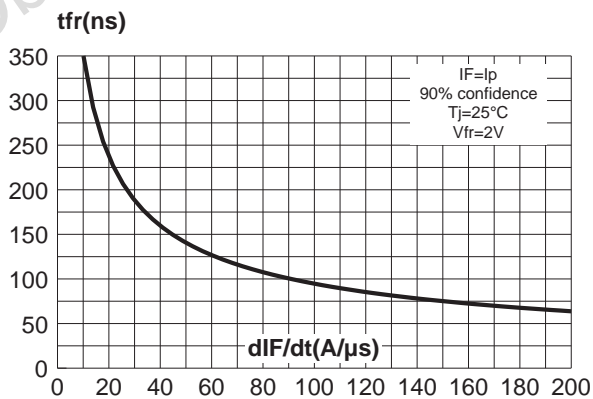
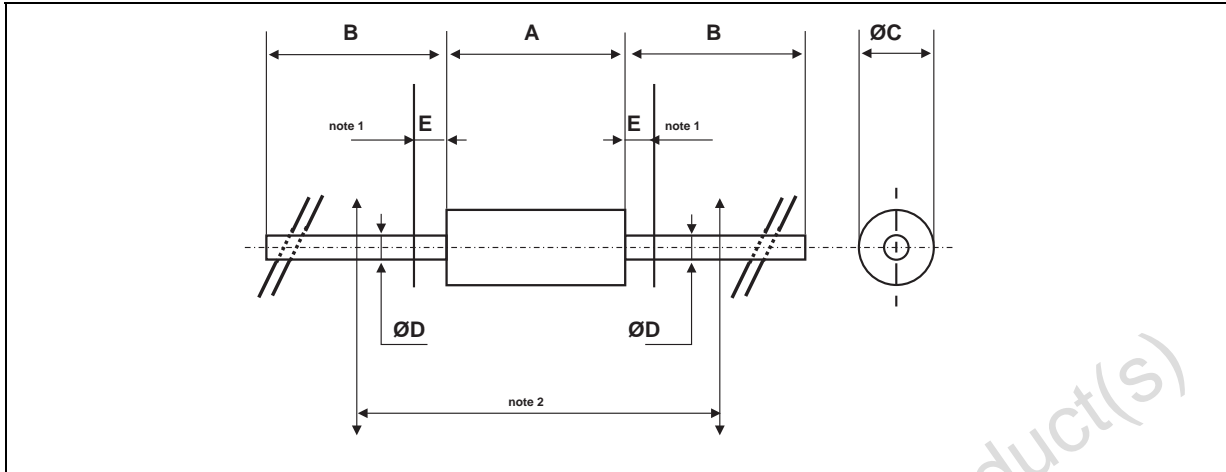

Fig. 8 Forward recovery time versus dI_F/dt .



STTA406

PACKAGE MECHANICAL DATA
DO-201AD



REF.	DIMENSIONS				NOTES
	Millimeters		Inches		
	Min.	Max.	Min.	Max.	
A		9.50		0.374	1 - The lead diameter $\varnothing D$ is not controlled over zone E 2 - The minimum axial length within which the device may be placed with its leads bent at right angles is 0.59" (15 mm)
B	25.40		1.000		
$\varnothing C$		5.30		0.209	
$\varnothing D$		1.30		0.051	
E		1.25		0.049	

Ordering type	Marking	Package	Weight	Base qty	Delivery mode
STTA406	STTA406	DO-201AD	1.166g	600	Ammopack
STTA406RL	STTA406	DO-201AD	1.166g	1900	Tape & reel

- Cooling method: by convection (method A)
- Band indicated cathode
- Epoxy meets UL94,V0

Information furnished is believed to be accurate and reliable. However, STMicroelectronics assumes no responsibility for the consequences of use of such information nor for any infringement of patents or other rights of third parties which may result from its use. No license is granted by implication or otherwise under any patent or patent rights of STMicroelectronics. Specifications mentioned in this publication are subject to change without notice. This publication supersedes and replaces all information previously supplied. STMicroelectronics products are not authorized for use as critical components in life support devices or systems without express written approval of STMicroelectronics.

The ST logo is a registered trademark of STMicroelectronics

© 1999 STMicroelectronics - Printed in Italy - All rights reserved.

STMicroelectronics GROUP OF COMPANIES

Australia - Brazil - China - Finland - France - Germany - Hong Kong - India - Italy - Japan - Malaysia
 Malta - Morocco - Singapore - Spain - Sweden - Switzerland - United Kingdom - U.S.A.

<http://www.st.com>