

## Excellent Integrated System Limited

Stocking Distributor

Click to view price, real time Inventory, Delivery & Lifecycle Information:

[STMicroelectronics](#)  
[TSA1204IFT](#)

For any questions, you can email us directly:

[sales@integrated-circuit.com](mailto:sales@integrated-circuit.com)



# TSA1204

## Dual channel 12-bit 20Mps 120mW A/D converter

### Features

- 0.5 Msps to 20 Msps sampling frequency
- Adaptive power consumption: 120 mW @ 20 Msps, 95 mW@10 Msps
- Single supply voltage: 2.5 V
- Independent supply for CMOS output stage with 2.5 V/3.3 V capability
- ENOB=11.2 @ Nyquist
- SFDR= -81.5 dBc @ Nyquist
- 1GHz analog bandwidth track-and-hold
- Common clocking between channels
- Dual simultaneous sample and hold inputs
- Multiplexed outputs
- Built-in reference voltage with external bias capability.

### Description

The TSA1204 is a new generation of high speed, dual-channel analog-to-digital converters implemented in a mainstream 0.25  $\mu\text{m}$  CMOS technology yielding high performance and very low power consumption.

The TSA1204 is specifically designed for applications requiring very low noise floor, high SFDR and good insulation between channels. It is based on a pipeline structure and digital error correction to provide excellent static linearity and over 11.2 effective bits at  $F_S=20$  Msps, and  $F_{in}=10$  MHz.

For each channel, an integrated voltage reference simplifies the design and minimizes external components. It is nevertheless possible to use the circuit with external references.

The ADC outputs are multiplexed in a common bus with a small number of pins. A tri-state capability is available for the outputs, allowing chip selection.

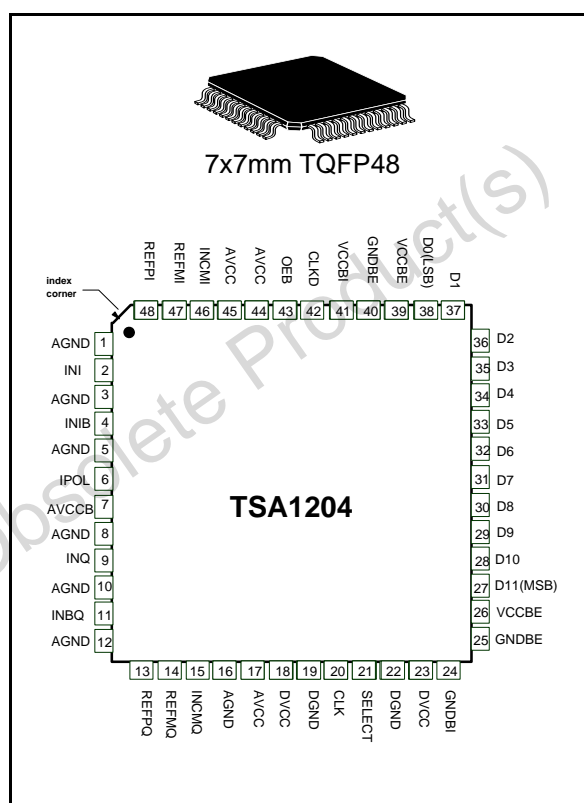

The inputs of the ADC must be differentially driven.

The TSA1204 is available in extended (-40° C to +85° C) temperature range, in a small 48-pin TQFP package.

### Applications

- Medical imaging and ultrasound
- 3G base station
- I/Q signal processing applications
- High speed data acquisition system
- Portable instrumentation

## Contents

<b>1</b>	<b>Schematic diagram</b> .....	<b>4</b>
<b>2</b>	<b>Pin descriptions</b> .....	<b>5</b>
<b>3</b>	<b>Dynamic characteristics</b> .....	<b>6</b>
<b>4</b>	<b>Timing characteristics</b> .....	<b>6</b>
<b>5</b>	<b>Absolute maximum ratings</b> .....	<b>7</b>
<b>6</b>	<b>Operating conditions</b> .....	<b>7</b>
<b>7</b>	<b>Electrical characteristics</b> .....	<b>8</b>
<b>8</b>	<b>Application information</b> .....	<b>15</b>
8.1	Additional functions .....	15
8.1.1	Output enable mode (OEB) .....	15
8.1.2	Select mode (SELECT) .....	15
8.2	References and common mode connection .....	16
8.2.1	Internal reference and common mode .....	16
8.2.2	External reference and common mode .....	16
8.3	Driving the differential analog inputs .....	17
8.4	Clock input .....	18
8.5	Power consumption .....	18
8.6	Layout precautions .....	19
8.7	EVAL1204/BA evaluation board .....	19
8.7.1	Evaluation board operating conditions .....	22
8.7.2	Consumption adjustment .....	22
8.7.3	Single and differential inputs .....	22
8.7.4	Mode select .....	23
<b>9</b>	<b>Practical application examples</b> .....	<b>24</b>
9.1	Digital interface applications .....	24
9.2	Medical imaging application .....	24

TSA1204		Contents
<b>10</b>	<b>Definitions of specified parameters</b> .....	<b>25</b>
	Static parameters .....	25
	Dynamic parameters .....	25
<b>11</b>	<b>Package mechanical data</b> .....	<b>27</b>
<b>12</b>	<b>Ordering information</b> .....	<b>29</b>
<b>13</b>	<b>Revision history</b> .....	<b>30</b>

Obsolete Product(s) - Obsolete Product(s)

# 1 Schematic diagram

Figure 1. TSA1204 block diagram

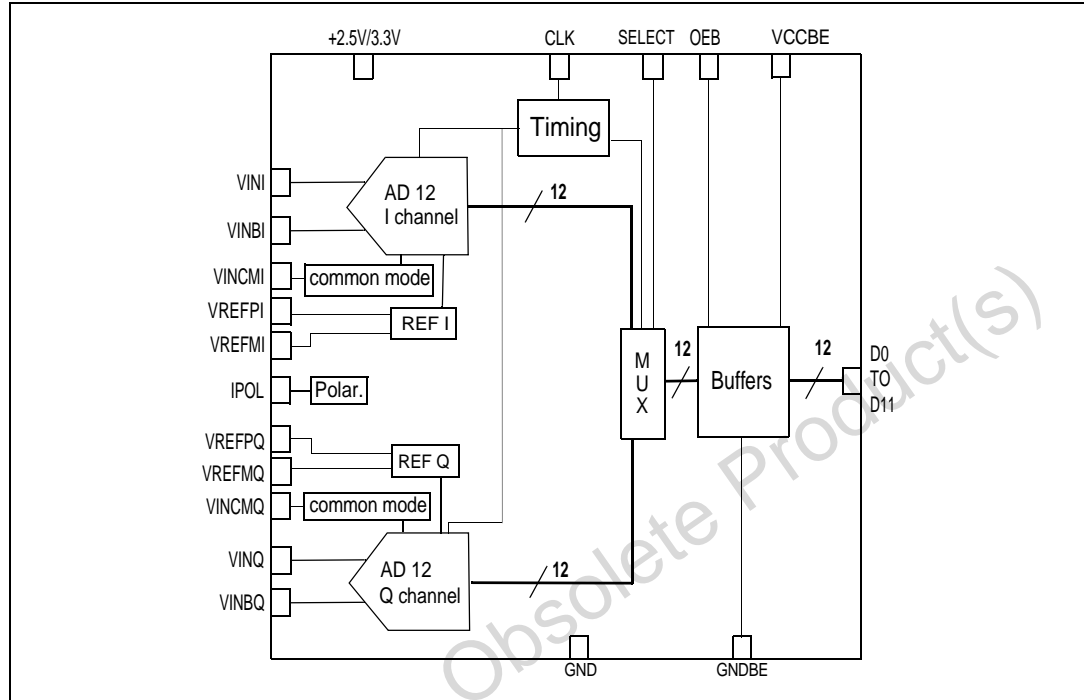
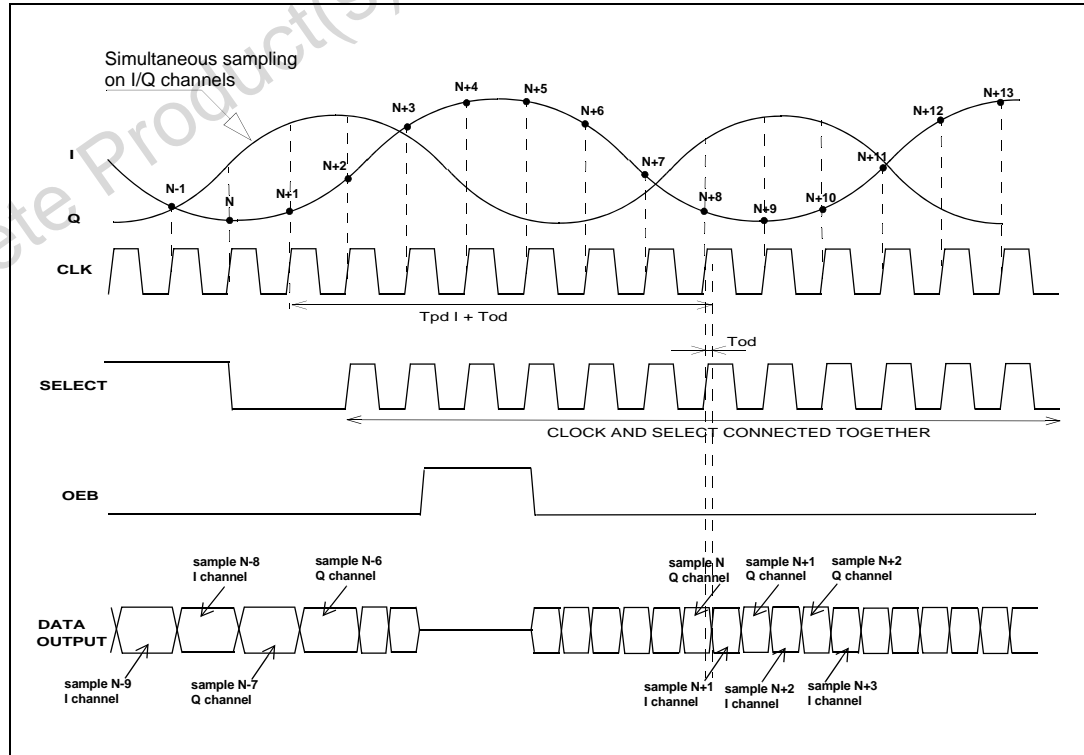

Figure 2. Timing diagram



## 2 Pin descriptions

Table 1. Pin descriptions (TQFP48 package)

Pin	Name	Description	Observation	Pin	Name	Description	Observation
1	AGND	Analog ground	0 V	25	GNDBE	Digital buffer ground	0 V
2	INI	I channel analog input		26	VCCBE	Digital Buffer power supply	2.5 V/3.3 V
3	AGND	Analog ground	0 V	27	D11(MSB)	Most Significant Bit output	CMOS output (2.5 V/3.3 V)
4	INBI	I channel inverted analog input		28	D10	Digital output	CMOS output (2.5 V/3.3 V)
5	AGND	Analog ground	0 V	29	D9	Digital output	CMOS output (2.5 V/3.3 V)
6	IPOL	Analog bias current input		30	D8	Digital output	CMOS output (2.5 V/3.3 V)
7	AVCC	Analog power supply	2.5 V	31	D7	Digital output	CMOS output (2.5 V/3.3 V)
8	AGND	Analog ground	0V	32	D6	Digital output	CMOS output (2.5 V/3.3 V)
9	INQ	Q channel analog input		33	D5	Digital output	CMOS output (2.5 V/3.3 V)
10	AGND	Analog ground	0 V	34	D4	Digital output	CMOS output (2.5 V/3.3 V)
11	INBQ	Q channel inverted analog input		35	D3	Digital output	CMOS output (2.5 V/3.3 V)
12	AGND	Analog ground	0 V	36	D2	Digital output	CMOS output (2.5 V/3.3 V)
13	REFPQ	Q channel top reference voltage		37	D1	Digital output	CMOS output (2.5 V/3.3 V)
14	REFMQ	Q channel bottom reference voltage	0 V	38	D0(LSB)	Least Significant Bit output	CMOS output (2.5 V/3.3 V)
15	INCMQ	Q channel input common mode		39	VCCBE	Digital Buffer power supply	2.5 V/3.3 V - See Application Note
16	AGND	Analog ground	0 V	40	GNDBE	Digital buffer ground	0 V
17	AVCC	Analog power supply	2.5 V	41	VCCBI	Digital Buffer power supply	2.5 V
18	DVCC	Digital power supply	2.5 V	42	CLKD	Data clock input	Idle at high level 2.5 V or 3.3 V
19	DGND	Digital ground	0 V	43	OEB	Output Enable input	2.5 V/3.3 V CMOS input
20	CLK	Clock input	2.5 V CMOS input	44	AVCC	Analog power supply	2.5 V
21	SELECT	Channel selection	2.5 V CMOS input	45	AVCC	Analog power supply	2.5 V
22	DGND	Digital ground	0V	46	INCM I	I channel input common mode	
23	DVCC	Digital power supply	2.5 V	47	REFMI	I channel bottom reference voltage	0 V
24	GNDBI	Digital buffer ground	0 V	48	REFPI	I channel top reference voltage	

### 3 Dynamic characteristics

Dynamic characteristics are measured at  $AV_{CC} = DV_{CC} = V_{CCB} = 2.5\text{ V}$ ,  $F_S = 20\text{ Msps}$ ,  $F_{in} = 10.5\text{ MHz}$ ,  $V_{in} @ -1\text{ dBFS}$ ,  $V_{REFP} = 1.0\text{ V}$ ,  $V_{REFM} = 0\text{ V}$  and  $T_{amb} = 25^\circ\text{ C}$  (unless otherwise specified).

**Table 2. Dynamic characteristics**

Symbol	Parameter	Test conditions	Min	Typ	Max	Unit
SFDR	Spurious free dynamic range			-81.5	-71.0	dBc
SNR	Signal to noise ratio		66.9	68.5		dB
THD	Total harmonics distortion			-80	-70	dBc
SINAD	Signal to noise and distortion ratio		64.8	68		dB
ENOB	Effective number of bits		10.6	11.2		bits

### 4 Timing characteristics

Timing characteristics are measured at  $AV_{CC} = DV_{CC} = V_{CCB} = 2.5\text{ V}$ ,  $F_S = 20\text{ Msps}$ ,  $F_{in} = 10.5\text{ MHz}$ ,  $V_{in} @ -1\text{ dBFS}$ ,  $V_{REFP} = 1.0\text{ V}$ ,  $V_{REFM} = 0\text{ V}$  and  $T_{amb} = 25^\circ\text{ C}$  (unless otherwise specified).

**Table 3. Timing characteristics**

Symbol	Parameter	Test conditions	Min	Typ	Max	Unit
$F_S$	Sampling frequency		0.5		20	MHz
DC	Clock duty cycle		45	50	55	%
TC1	Clock pulse width (high)		22.5	25		ns
TC2	Clock pulse width (low)		22.5	25		ns
$T_{od}$	Data output delay (clock edge to data valid)	10 pF load capacitance		9		ns
$T_{pd I}$	Data pipeline delay for channel I			7		cycles
$T_{pd Q}$	Data pipeline delay for channel Q			7.5		cycles
$T_{on}$	Falling edge of OEB to digital output valid data			1		ns
$T_{off}$	Rising edge of OEB to digital output tri-state			1		ns

## 5 Absolute maximum ratings

Table 4. Absolute maximum ratings

Symbol	Parameter	Values	Unit
$V_{CC}$	Analog supply voltage <sup>(1)</sup>	0 to 3.3	V
$DV_{CC}$	Digital supply voltage <sup>(1)</sup>	0 to 3.3	V
$V_{CCBE}$	Digital buffer supply voltage <sup>(1)</sup>	0 to 3.6	V
$V_{CCBI}$	Digital buffer supply voltage <sup>(1)</sup>	0 to 3.3	V
$I_{Dout}$	Digital output current	-100 to 100	mA
$T_{stg}$	Storage temperature	+150	°C
ESD	HBM: human body model <sup>(2)</sup>	2	kV
	CDM: charged device model <sup>(3)</sup>	1.5	
Latch-up	Class <sup>(4)</sup>	A	

1. All voltage values, except differential voltage, are with respect to network ground terminal. The magnitude of input and output voltages must not exceed -0.3 V or  $V_{CC}$ .
2. Electrostatic discharge pulse (ESD pulse) simulating a human body discharge of 100 pF through 1.5 kΩ
3. Discharge to ground of a device that has been previously charged.
4. ST Microelectronics corporate procedure number 0018695.

## 6 Operating conditions

Table 5. Operating conditions

Symbol	Parameter	Min	Typ	Max	Unit
$V_{CC}$	Analog supply voltage	2.25	2.5	2.7	V
$DV_{CC}$	Digital supply voltage	2.25	2.5	2.7	V
$V_{CCBE}$	External digital buffer supply voltage	1.8	2.5	3.5	V
$V_{CCBI}$	Internal digital buffer supply voltage	2.25	2.5	2.7	V
$V_{REFP I}$ $V_{REFP Q}$	Forced top voltage reference <sup>(1)</sup>	0.96		1.4	V
$V_{REFM I}$ $V_{REFM Q}$	Forced bottom reference voltage <sup>(1)</sup>	0		0.4	V
$V_{INCM I}$ $V_{INCM Q}$	Forced input common mode voltage	0.2		1	V

1. Condition  $V_{REFP} - V_{REFM} > 0.3$  V



## 7 Electrical characteristics

Electrical characteristics are measured at  $AV_{CC} = DV_{CC} = V_{CCB} = 2.5\text{ V}$ ,  $F_S = 20\text{ Msps}$ ,  $F_{in} = 2\text{ MHz}$ ,  $V_{in} @ -1\text{ dBFS}$ ,  $V_{REFP} = 1.0\text{ V}$ ,  $V_{REFM} = 0\text{ V}$ , and  $T_{amb} = 25^\circ\text{ C}$  (unless otherwise specified).

**Table 6. Analog inputs**

Symbol	Parameter	Test conditions	Min	Typ	Max	Unit
$V_{IN} - V_{INB}$	Full scale reference voltage	Differential inputs mandatory	1.1	2.0	2.8	V <sub>pp</sub>
$C_{in}$	Input capacitance			7.0		pF
$R_{eq}$	Equivalent input resistor			3		K $\Omega$
BW	Analog input bandwidth	$V_{in} @ \text{full scale}$ , $F_S = 20\text{ Msps}$		1000		MHz
ERB	Effective resolution bandwidth			70		MHz

**Table 7. Digital inputs and outputs**

Symbol	Parameter	Test conditions	Min	Typ	Max	Unit
<b>Clock and select inputs</b>						
$V_{IL}$	Logic "0" voltage			0	0.8	V
$V_{IH}$	Logic "1" voltage		2.0	2.5		V
<b>OEB input</b>						
$V_{IL}$	Logic "0" voltage			0	$0.25 \times V_{CCBE}$	V
$V_{IH}$	Logic "1" voltage		$0.75 \times V_{CCBE}$	$V_{CCBE}$		V
<b>Digital outputs</b>						
$V_{OL}$	Logic "0" voltage	$I_{OL} = 10\ \mu\text{A}$		0	$0.1 \times V_{CCBE}$	V
$V_{OH}$	Logic "1" voltage	$I_{OH} = 10\ \mu\text{A}$	$0.9 \times V_{CCBE}$	$V_{CCBE}$		V
$I_{OZ}$	High impedance leakage current	OEB set to $V_{IH}$	-1.7		1.7	$\mu\text{A}$
$C_L$	Output load capacitance				15	pF

**Table 8. Reference voltage**

Symbol	Parameter	Test conditions	Min	Typ	Max	Unit
$V_{REFP}$ $V_{REFPQ}$	Top internal reference voltage		0.807	0.89	0.963	V
$V_{INCM}$ $V_{INCMQ}$	Input common mode voltage		0.40	0.46	0.52	V

TSA1204

Electrical characteristics

**Table 9. Power consumption**

Symbol	Parameter	Min	Typ	Max	Unit
I <sub>CCA</sub>	Analog supply current		40	49.5	mA
I <sub>CCD</sub>	Digital supply current		2	3	mA
I <sub>CCBE</sub>	Digital buffer supply current (10 pF load)		6.2	9	mA
I <sub>CCBI</sub>	Digital buffer supply current		73	221	μA
P <sub>d</sub>	Power consumption in normal operation mode		120	155	mW
R <sub>thja</sub>	Thermal resistance (TQFP48)		80		°C/W

**Table 10. Accuracy**

Symbol	Parameter	Min	Typ	Max	Unit
OE	Offset error	-1.8	-0.5	1.8	LSB
GE	Gain error	-0.1	0	0.1	%
DNL	Differential non linearity	-0.93	±0.4	+0.93	LSB
INL	Integral non linearity	-1.8	±0.8	+1.8	LSB
	Monotonicity and no missing codes	Guaranteed			

**Table 11. Matching between channels**

Symbol	Parameter	Min	Typ	Max	Unit
GM	Gain match		0.033	0.1	%
OM	Offset match		0.4	2.5	LSB
PHM	Phase match		1		dg
XTLK	Crosstalk rejection		87		dB

**Electrical characteristics**

**TSA1204**

**Figure 3. Static parameter: integral non linearity<sup>(a)</sup>**

$F_S=20$  MSPS;  $I_{CCA}=40$  mA;  $F_{in}=2$  MHz

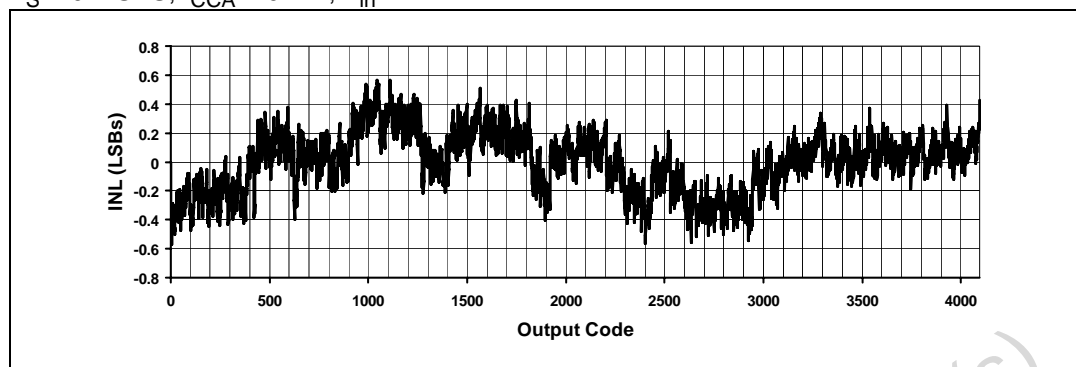

**Figure 4. Static parameter: differential non linearity<sup>(a)</sup>**

$F_S=20$  MSPS;  $I_{CCA}=40$  mA;  $F_{in}=2$  MHz

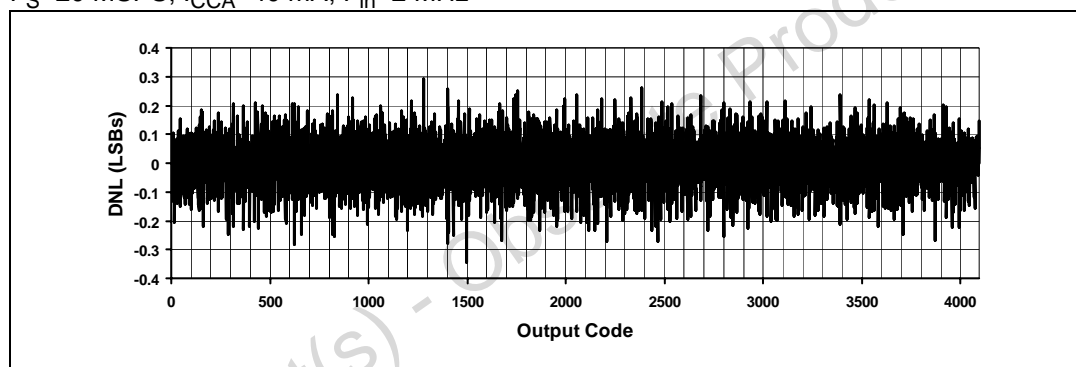

a. For parameter definitions, see [Section 10: Definitions of specified parameters on page 25](#).

TSA1204

Electrical characteristics

**Figure 5. Linearity vs.  $F_S$**   
 $F_{in}=5\text{MHz}$ ;  $R_{pol}$  adjustment

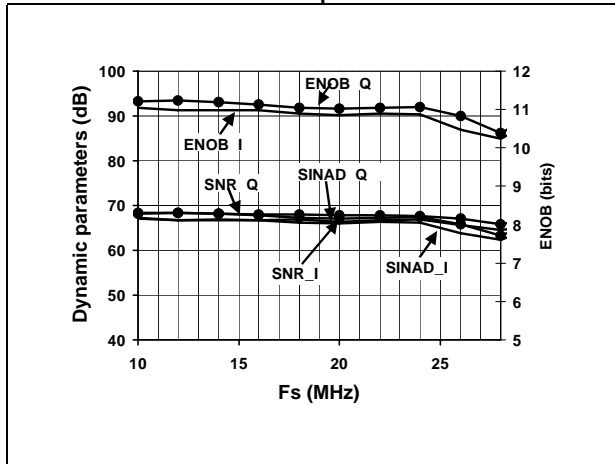

**Figure 6. Distortion vs.  $F_S$**   
 $F_{in}=5\text{MHz}$ ;  $R_{pol}$  adjustment

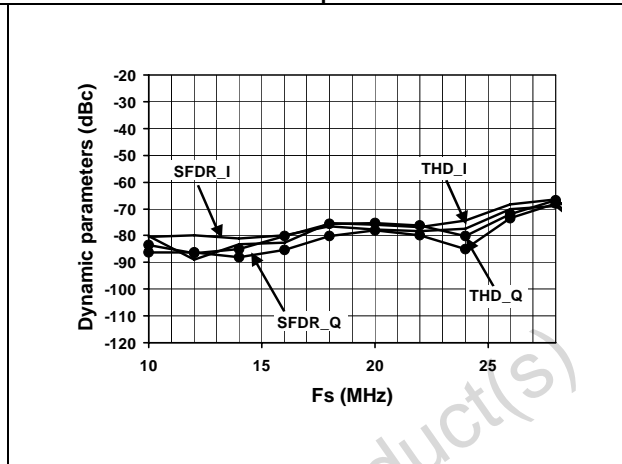

**Figure 7. Linearity vs.  $F_{in}$**   
 $F_S=20\text{Mpsps}$ ;  $I_{CCA}=40\text{mA}$

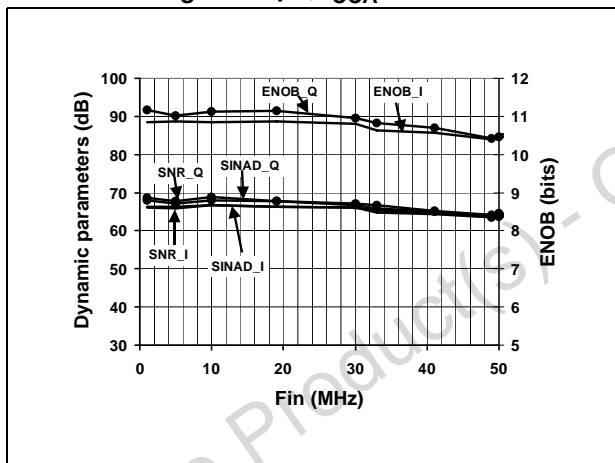

**Figure 8. Distortion vs.  $F_{in}$**   
 $F_S=20\text{Mpsps}$ ;  $I_{CCA}=40\text{mA}$

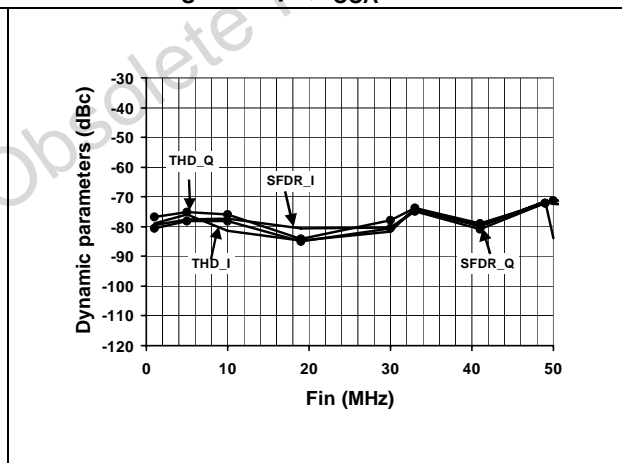

**Figure 9. Linearity vs. Temperature**  
 $F_S=20\text{Mpsps}$ ;  $I_{CCA}=40\text{mA}$ ;  $F_{in}=2\text{MHz}$

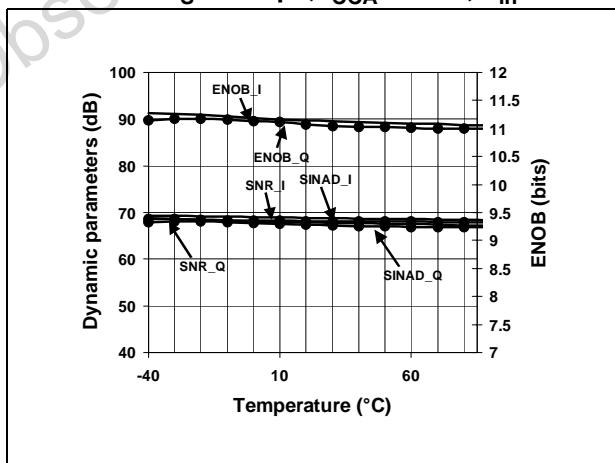

**Figure 10. Distortion vs. Temperature**  
 $F_S=20\text{Mpsps}$ ;  $I_{CCA}=40\text{mA}$ ;  $F_{in}=2\text{MHz}$

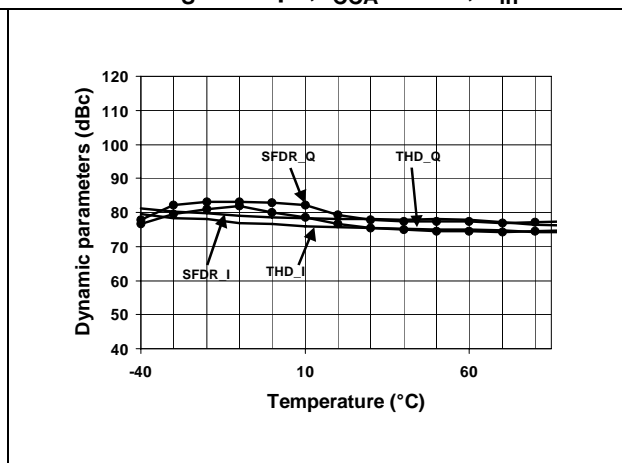

Electrical characteristics

TSA1204

**Figure 11. Linearity vs.  $AV_{CC}$**   
 $F_S=20\text{Mpsps}$ ;  $I_{CCA}=40\text{mA}$ ;  $F_{in}=5\text{MHz}$

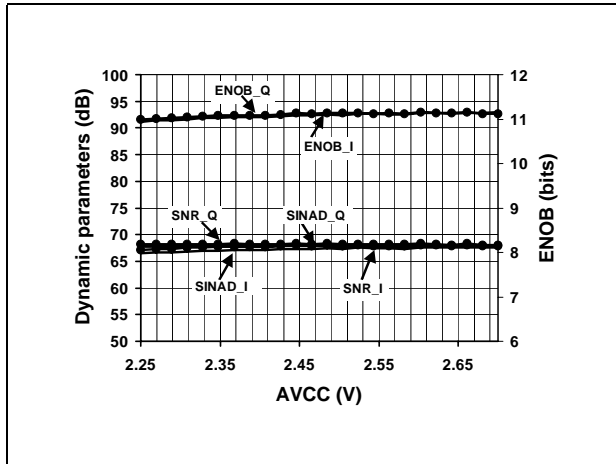

**Figure 12. Distortion vs.  $AV_{CC}$**   
 $F_S=20\text{Mpsps}$ ;  $I_{CCA}=40\text{mA}$ ;  $F_{in}=5\text{MHz}$

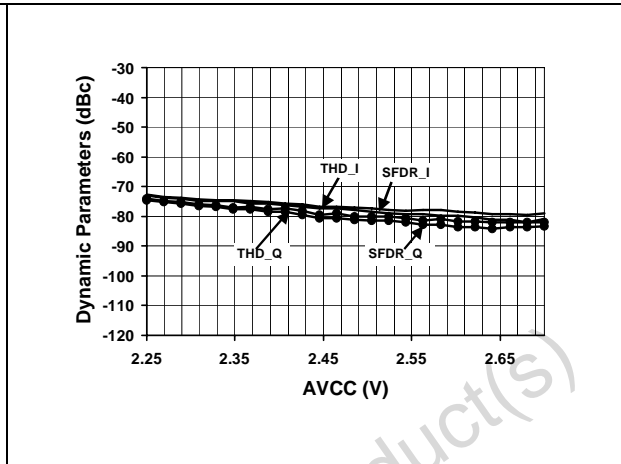

**Figure 13. Linearity vs.  $DV_{CC}$**   
 $F_S=20\text{Mpsps}$ ;  $I_{CCA}=40\text{mA}$ ;  $F_{in}=5\text{MHz}$

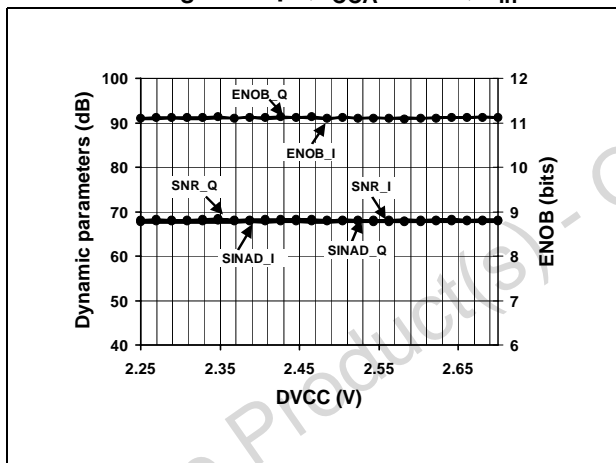

**Figure 14. Distortion vs.  $DV_{CC}$**   
 $F_S=20\text{Mpsps}$ ;  $I_{CCA}=40\text{mA}$ ;  $F_{in}=5\text{MHz}$

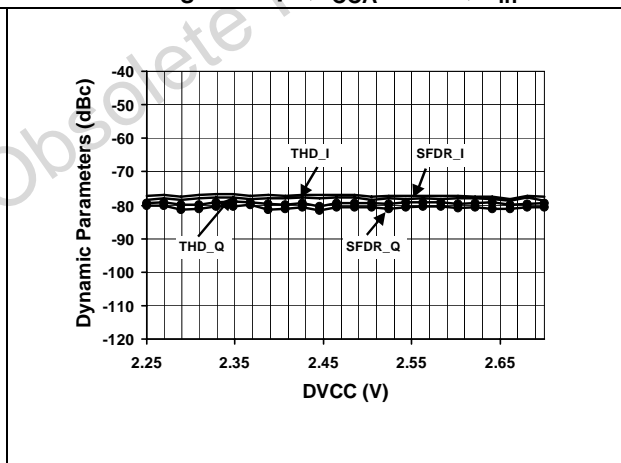

**Figure 15. Linearity vs.  $V_{CCBI}$**   
 $F_S=20\text{Mpsps}$ ;  $I_{CCA}=40\text{mA}$ ;  $F_{in}=5\text{MHz}$

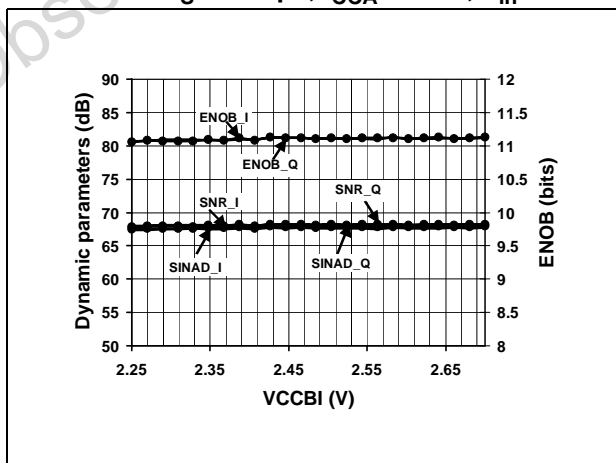

**Figure 16. Distortion vs.  $V_{CCBI}$**   
 $F_S=20\text{Mpsps}$ ;  $I_{CCA}=40\text{mA}$ ;  $F_{in}=5\text{MHz}$

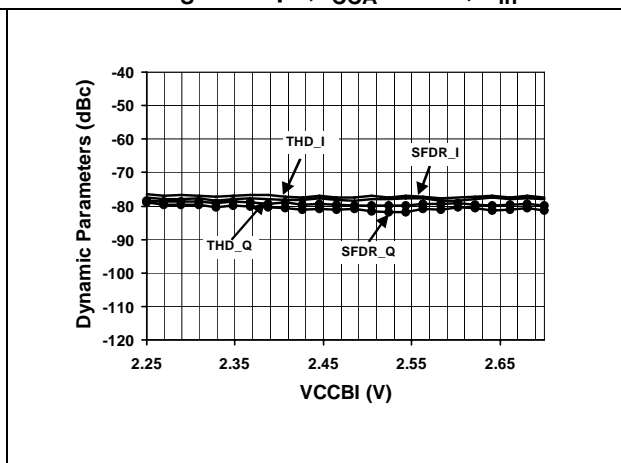

TSA1204

Electrical characteristics

**Figure 17. Linearity vs.  $V_{CCBE}$**   
 $F_S=20\text{MSPS}$ ;  $I_{CCA}=40\text{mA}$ ;  $F_{in}=5\text{MHz}$

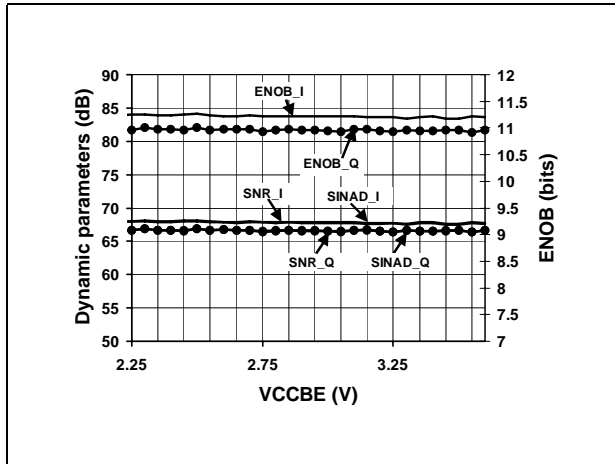

**Figure 18. Distortion vs.  $V_{CCBE}$**   
 $F_S=20\text{MSPS}$ ;  $I_{CCA}=40\text{mA}$ ;  $F_{in}=5\text{MHz}$

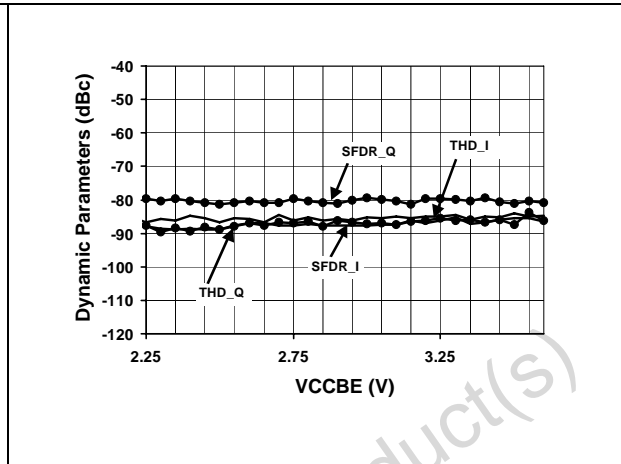

**Figure 19. Linearity vs. duty cycle**  
 $F_S=20\text{MSPS}$ ;  $I_{CCA}=40\text{mA}$ ;  $F_{in}=5\text{MHz}$

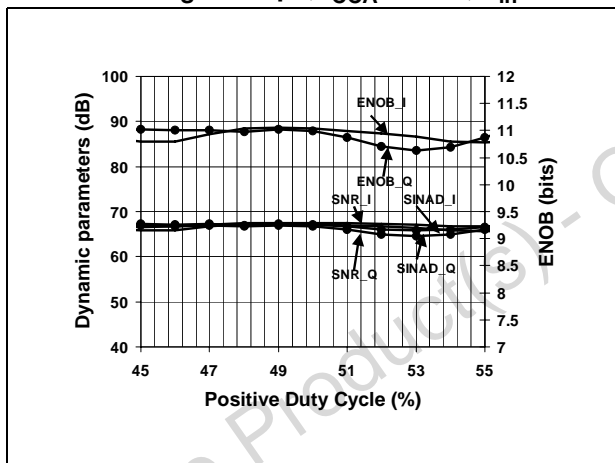

**Figure 20. Distortion vs. duty cycle**  
 $F_S=20\text{MSPS}$ ;  $I_{CCA}=40\text{mA}$ ;  $F_{in}=5\text{MHz}$

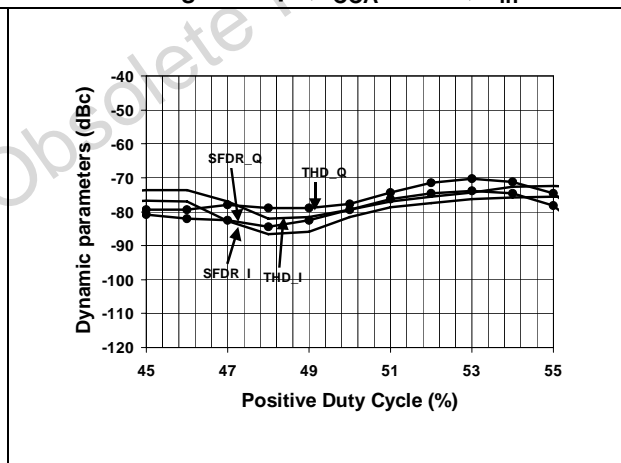

**Electrical characteristics**

**TSA1204**

**Figure 21. Single-tone 8K FFT at 20Mps - Channel I**

$F_{in}=5\text{MHz}$ ;  $I_{CCA}=40\text{mA}$ ,  $V_{in}@-1\text{dBFS}$

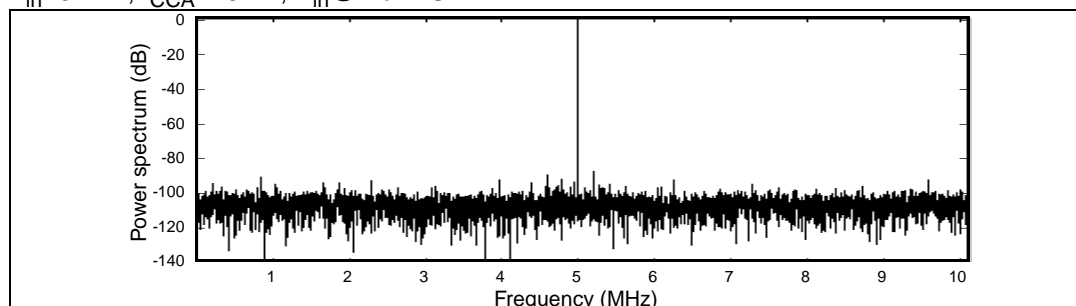

**Figure 22. Dual-tone 8K FFT at 20Mps - Channel I**

$F_{in1}=9.7\text{MHz}$ ;  $F_{in2}=10.7\text{MHz}$ ;  $I_{CCA}=40\text{mA}$ ,  $V_{in1}@-7\text{dBFS}$ ;  $V_{in2}@-7\text{dBFS}$ ;  $\text{IMD}=-76\text{dBc}$

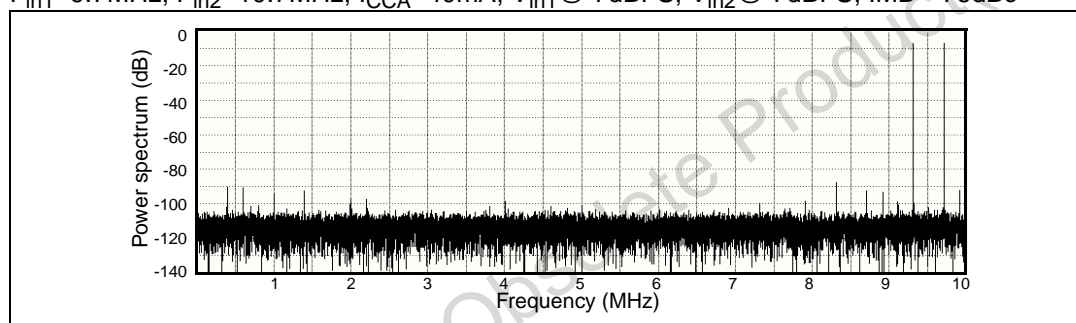

## 8 Application information

The TSA1204 is a dual-channel, 12-bit resolution analog-to-digital converter based on a pipeline structure and the latest deep submicron CMOS process to achieve the best performance in terms of linearity and power consumption.

Each channel achieves 12-bit resolution through the pipeline structure which consists of 12 internal conversion stages in which the analog signal is fed and sequentially converted into digital data. A latency time of 7 clock periods is necessary to obtain the digitized data on the output bus.

The input signals are simultaneously sampled, for both channels, on the rising edge of the clock. The output data is delivered on the rising edge of the clock for channel I and on the falling edge of the clock for channel Q, as shown in [Figure 2: Timing diagram on page 4](#). The digital data produced at the different stages must be time delayed according to the order of conversion. Finally, a digital data correction completes the processing and ensures the validity of the ending codes on the output bus.

The structure is specifically designed to accept differential signals only.

### 8.1 Additional functions

To simplify the application board as much as possible, the following operating modes are provided:

- Output enable mode (OEB)
- Select mode (SELECT)

#### 8.1.1 Output enable mode (OEB)

When set to low level ( $V_{IL}$ ), all digital outputs remain active and are in low impedance state. When set to high level ( $V_{IH}$ ), all digital output buffers are in high impedance state while the converter goes on sampling. When OEB is set to a low level again, the data arrives on the output with a very short  $T_{on}$  delay. This mechanism allows the chip select of the device.

[Figure 2: Timing diagram on page 4](#) summarizes this functionality.

If you do not want to use OEB mode, the OEB pin should be grounded through a low value resistor.

#### 8.1.2 Select mode (SELECT)

The digital data output from each of the ADC cores is multiplexed to share the same output bus. This prevents an increase in the number of pins and allows to use the same package as for a single-channel ADC like the TSA1201.

The information channel is selected with the "SELECT" pin. When set to high level ( $V_{IH}$ ), channel I data is present on the D0-D11 output bus. When set to low level ( $V_{IL}$ ), channel Q data is delivered on D0-D11.

By connecting SELECT to CLK, channel I and channel Q are simultaneously present on D0-D11, channel I on the rising edge of the clock and channel Q on the falling edge of the clock. (Refer to [Figure 2: Timing diagram on page 4](#)).



## 8.2 References and common mode connection

VREFM must always be connected externally.

### 8.2.1 Internal reference and common mode

In the default configuration, the ADC operates with its own reference and common mode voltages generated by its internal bandgap. It is recommended to decouple the VREFP and INCM pins in order to minimize low and high frequency noise (see [Figure 23](#)).

**Figure 23. Internal reference and common mode setting**

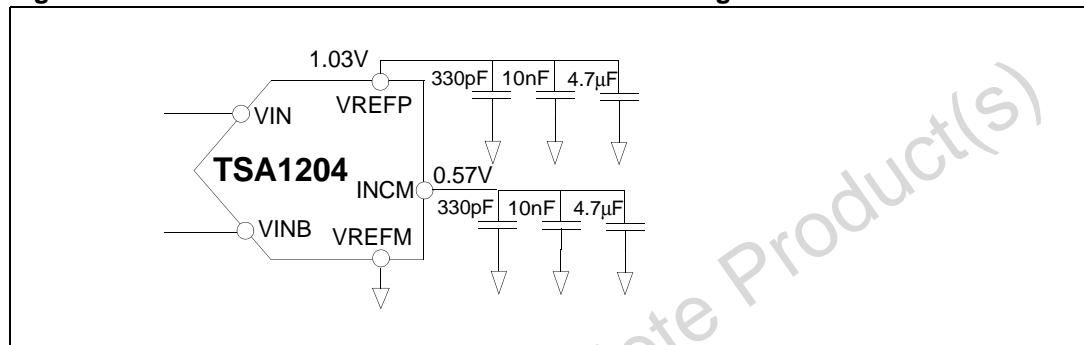

### 8.2.2 External reference and common mode

Each of the voltages  $V_{REFM}$ ,  $V_{REFP}$  and  $INCM$  can be fixed externally to better fit to the application needs (refer to [Table 5: Operating conditions on page 7](#) for min/max values). It is possible to use an external reference voltage device for specific applications requiring even better linearity, accuracy or enhanced temperature behavior.

The  $V_{REFP}$  and  $V_{REFM}$  voltages set the analog dynamic range at the input of the converter that has a full scale amplitude of  $2 \cdot (V_{REFP} - V_{REFM})$ .

The  $INCM$  voltage is half the value of  $V_{REFP} - V_{REFM}$ .

The best linearity and distortion performance is achieved with a dynamic range above  $2 V_{pp}$  and by increasing the  $V_{REFM}$  voltage instead of lowering the  $V_{REFP}$  one.

To obtain the highest performance from the TSA1204 device, we recommend implementing the configuration shown in [Figure 24](#) with the STMicroelectronics TS821 or TS4041-1.2 Vref.

**Figure 24. External reference setting**

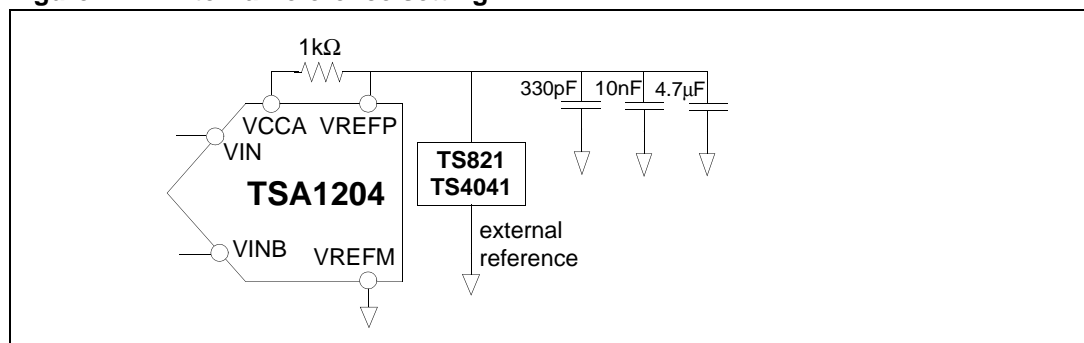

### 8.3 Driving the differential analog inputs

The TSA1204 is designed to deliver optimum performance when driven on differential inputs. An RF transformer is an efficient way of achieving this high performance.

Figure 25 describes the schematics. The input signal is fed to the primary of the transformer, while the secondary drives both ADC inputs. The common mode voltage of the ADC (INCM) is connected to the center-tap of the secondary of the transformer in order to bias the input signal around this common voltage, internally set to 0.46 V. It determines the DC component of the analog signal. Being a high impedance input, it acts as an I/O and can be externally driven to adjust this DC component. The INCM is decoupled to maintain a low noise level on this node. Our evaluation board is mounted with a 1:1 ADT1-1WT transformer from Minicircuits. You might also use a higher impedance ratio (1:2 or 1:4) to reduce the driving requirement on the analog signal source.

Each analog input can drive a 1.4 V<sub>pp</sub> amplitude input signal, so the resulting differential amplitude is 2.8 V<sub>pp</sub>.

Figure 25. Differential input configuration with transformer

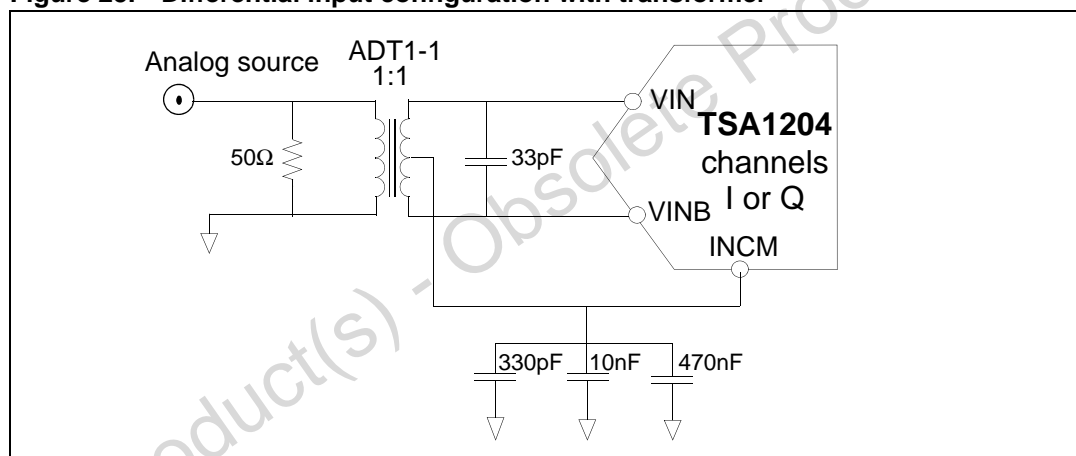

Figure 26. AC-coupled differential input

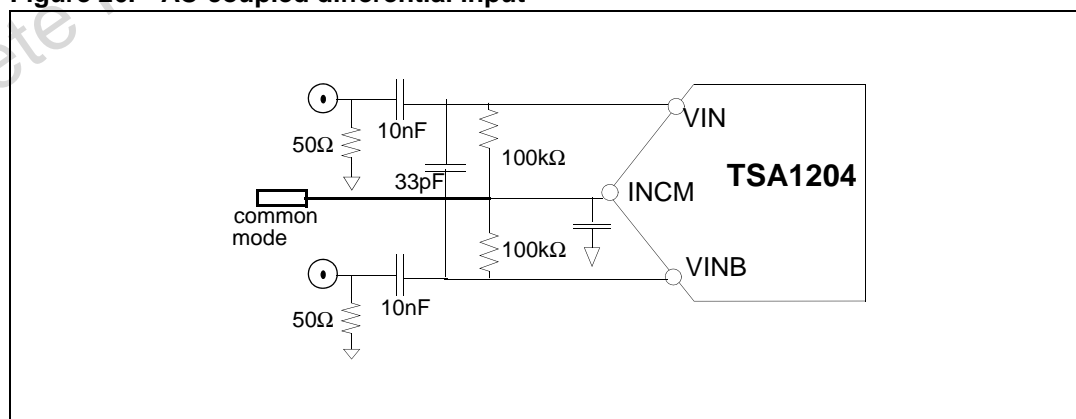

Figure 26 represents the biasing of a differential input signal in AC-coupled differential input configuration. Both inputs V<sub>IN</sub> and V<sub>INB</sub> are centered around the common mode voltage, that can be let internal or fixed externally.

**Figure 27. DC-coupled 2 V<sub>pp</sub> differential analog input**

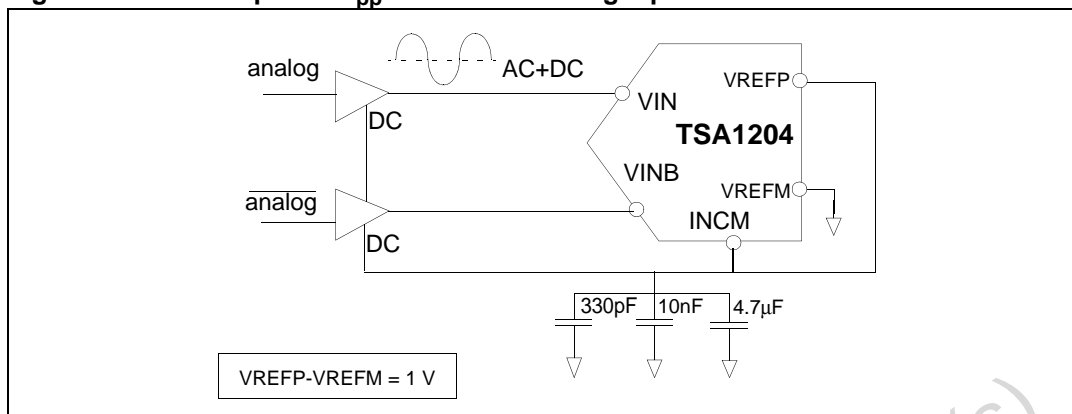

Figure 27 shows a DC-coupled configuration with forced VREFP and INCM to the 1 V DC analog input while VREFM is connected to ground; the differential amplitude obtained is 2 V<sub>pp</sub>.

## 8.4 Clock input

The quality of your TSA1204 converter is very dependent on your clock input accuracy, in terms of aperture jitter; the use of a low jitter crystal controlled oscillator is recommended.

Further points to consider in your implementation are:

- The duty cycle must be between 45% and 55%.
- The clock power supplies must be independent from the ADC output supplies to avoid digital noise modulation on the output.
- When powered-on, the circuit needs several clock periods to reach its normal operating conditions. Therefore, it is recommended to keep the circuit clocked to avoid random states before applying the supply voltages.

## 8.5 Power consumption optimization

The internal architecture of the TSA1204 makes it possible to optimize power consumption according to the sampling frequency of the application. For this purpose, an external resistor is placed between I<sub>PO</sub>L and the analog ground pins. Therefore, the total dissipation can be optimized over the full sampling range (0.5 Msps up to 20 Msps).

The TSA1204 combines the highest performance and the lowest consumption at 20 Msps when R<sub>po</sub>l is equal to 54 kΩ. This value is nevertheless dependent on the application and the environment.

In the lower sampling frequency range, this value of resistor may be adjusted in order to decrease the analog current without any degradation of the dynamic performance.

Table 12 gives some values to illustrate this.

**Table 12. Total power consumption optimization depending on  $R_{pol}$  value**

$F_S$ (MSPS)	10	20
$R_{pol}$ (k $\Omega$ )	120	54
Optimized power (mW)	95	120

## 8.6 Layout precautions

To use the ADC circuits most efficiently at high frequencies, some precautions have to be taken for power supplies:

- First of all, the implementation of 4 proper separate supplies and ground planes (analog, digital, internal and external buffer ones) on the PCB is recommended for high speed circuit applications to provide low inductance and low resistance common return. The separation of the analog signal from the digital output part is mandatory to prevent noise from coupling onto the input signal. The best compromise is to connect AGND, DGND, GNDBI in a common point whereas GNDBE must be isolated. Similarly, the AVCC, DVCC and VCCBI power supplies must be separate from the VCCBE power supply.
- Power supply bypass capacitors must be placed as close as possible to the IC pins in order to improve high frequency bypassing and reduce harmonic distortion.
- All inputs and outputs must be properly terminated with output termination resistors; then the amplifier load is resistive only and the stability of the amplifier is improved. All leads must be wide and as short as possible especially for the analog input in order to decrease parasitic capacitance and inductance.
- To keep the capacitive loading as low as possible at digital outputs, short lead lengths of routing are essential to minimize currents when the output changes. To minimize this output capacitance, use buffers or latches close to the output pins.
- Choose component sizes as small as possible (SMD).

## 8.7 EVAL1204/BA evaluation board

The EVAL1204/BA is a 4-layer board with high decoupling and grounding level. The schematic of the evaluation board is shown in [Figure 30](#) and its top overlay view in [Figure 29](#). The board has been characterized with a fully devoted ADC test bench as shown in [Figure 28](#).

**Figure 28. Analog-to-digital converter characterization bench**

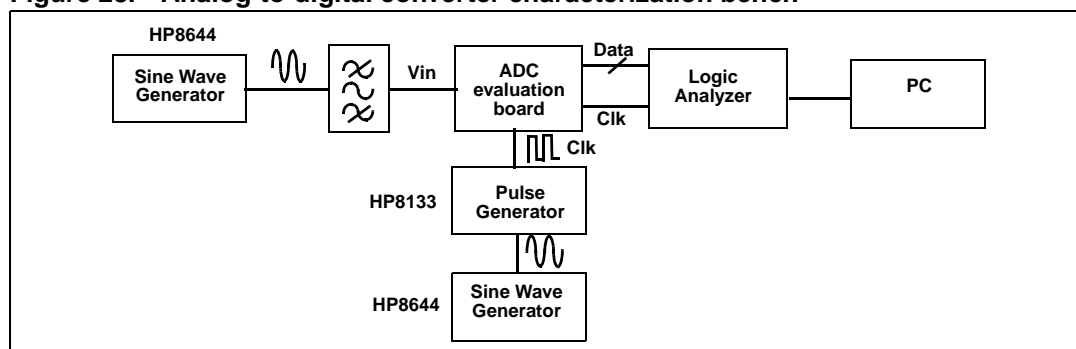

Application information

TSA1204

Note: The analog signal must be filtered to be very pure. The data ready signal is the acquisition clock of the logic analyzer. The ADC digital outputs are latched by the octal buffers 74LCX573. All characterization measurements are made with SFSR=1 dB for static parameters.

Figure 29. Evaluation board printed circuit

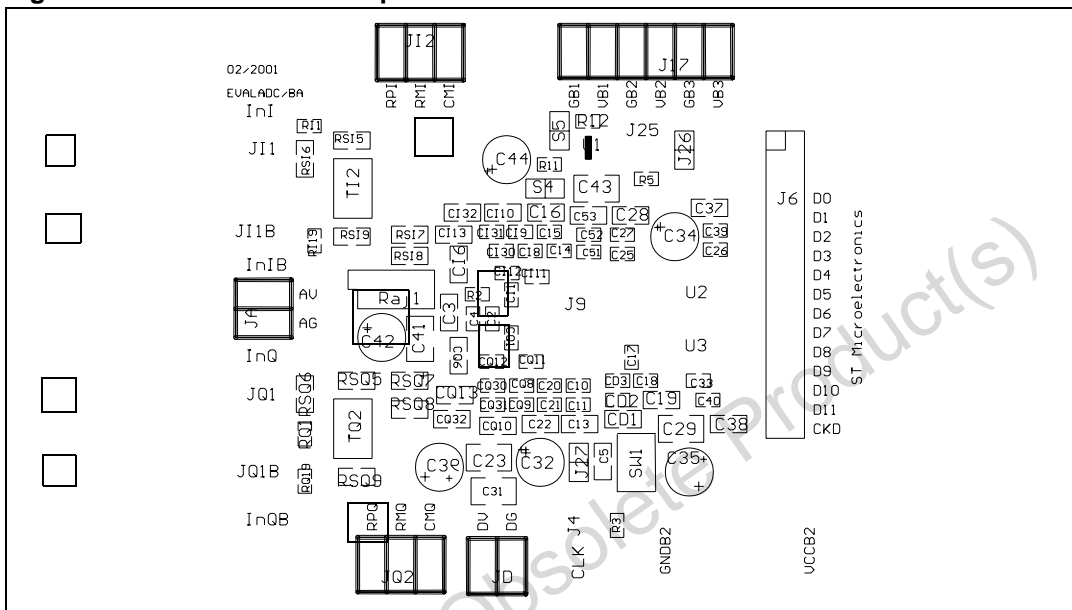

Table 13. Printed circuit board - list of components

Name	Part Type	Footprint	Name	Part Type	Footprint	Name	Part Type	Footprint	Name	Part Type	Footprint
RSQ6	0	805	CD2	10nF	603	C26	330pF	603	CQ6	NC	805
RSQ7	0	805	C40	10nF	603	C20	330pF	603	CI6	NC	805
RSQ8	0	805	C39	10nF	603	C33	330pF	603	U2	74LCX573	TSSOP20
RSI6	0	805	CQ12	10nF	603	C25	330pF	603	U3	74LCX573	TSSOP20
RSI7	0	805	CQ9	10nF	603	CI1	33pF	603	U1	STG719	SOT23-6
RSI8	0	805	C52	10nF	603	CQ1	33pF	603	JA	ANALOGIC	connector
R3	47	603	C18	10nF	603	C34	47µF	RB.1	J17	BUFP0W	connector
R5	47	603	C21	10nF	603	C42	47µF	RB.1	J25	CKDATA	SMA
RQ19	47	603	C4	10nF	603	C35	47µF	RB.1	J4	CLK	SMA
RI1	47	603	C15	10nF	603	C44	47µF	RB.1	J27	CON2	SIP2
RQ1	47	603	C27	10nF	603	C36	47µF	RB.1	J26	CON2	SIP2
RI19	47	603	C11	10nF	603	C32	47µF	RB.1	JD	DIGITAL	connector
RSI9	0NC	805	CI9	10nF	603	C37	470nF	805	J11	InI	SMA
RSQ5	0NC	805	CI12	10nF	603	CQ10	470nF	805	J11B	InIB	SMA
RSQ9	0NC	805	CI31	10nF	603	C28	470nF	805	JQ1	InQ	SMA
RSI5	0NC	805	CQ31	10nF	603	CI10	470nF	805	JQ1B	InQB	SMA
R24	0NC	805	CQ30	330pF	603	CQ32	470nF	805	SW1	SWITCH	connector
R23	0NC	805	CI11	330pF	603	CQ13	470nF	805	S5	SW-SPST	connector
R21	0NC	805	C51	330pF	603	CI32	470nF	805	S4	SW-SPST	connector
R22	0NC	805	C2	330pF	603	C13	470nF	805	TI2	T2-AT1-1WT	ADT
R2	1K	603	CI17	330pF	603	C53	470nF	805	TQ2	T2-AT1-1WT	ADT
R12	47K	603	CD3	330pF	603	C16	470nF	805	JI2	VREFI	connector
R11	47K	603	C10	330pF	603	C3	470nF	805	JQ2	VREFQ	connector
Raj1	200K	VR5	CQ8	330pF	603	C22	470nF	805	J6	32Pin	IDC-32
		trimmer	CQ11	330pF	603	CI13	470nF	805			connector
C23	10µF	1210	CI8	330pF	603	C38	470nF	805			
C41	10µF	1210	C14	330pF	603	CD1	470nF	805			NC: non soldered
C29	10µF	1210	CI30	330pF	603	C19	470nF	805			

TSA1204

Application information

Figure 30. TSA1204 evaluation board schematic

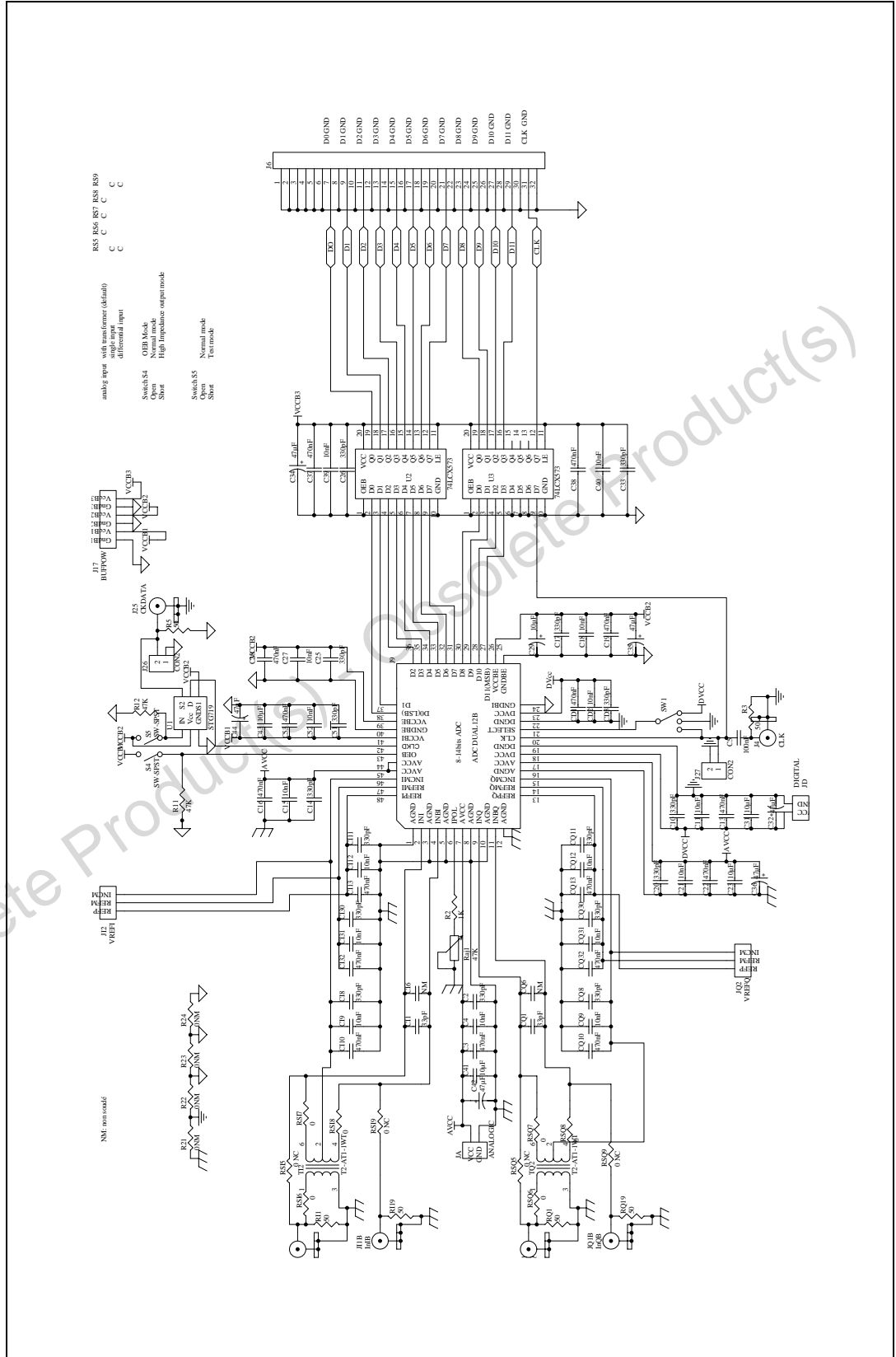

### 8.7.1 Evaluation board operating conditions

Table 14 below shows the connections to the board for the power supplies and other pins.

Table 14. Board connections for power supplies and other pins

Board marking	Connection	Internal voltage (V)	External voltage (V)
AV	AVCC		2.5
AG	AGND		0
RPI	REFPI	0.89	<1.4
RMI	REFMI		<0.4
CMI	INCM I	0.46	<1
RPQ	REFPQ	0.89	<1.4
RMQ	REFMQ		<0.4
CMQ	INCMQ	0.46	<1
DV	DVCC		2.5
DG	DGND		0
GB1	GNDBI		0
VB1	VCCBI		2.5
GB2	GNDBE		0
VB2	VCCBE		1.8/2.5/3.3
GB3	GNDB3		0
VB3	VCCB3		2.5

**Caution:** Do not use the VB3 power supply (5 V) dedicated to the 74LCX573 external buffers to supply the VB2 of the TSA1203 which cannot exceed 3.3 V.

### 8.7.2 Consumption adjustment

Before beginning characterization tests, make sure to adjust the  $R_{pol}$  (Raj1), and therefore  $I_{pol}$ , value according to your sampling frequency.

### 8.7.3 Single and differential inputs

The test board can be driven on a single analog input, or on differential inputs. With a single analog input, you must use the ADT1-1WT transformer to generate a differential signal. In this configuration, the resistors RSI6, RSI7, RSI8 for channel I (respectively RSQ6, RSQ7, RSQ8 for channel Q) are connected as short-circuits whereas RSI5, RSI9 (respectively RSQ5, RSQ9 for channel Q) are open circuits.

Alternatively, you can use the JI1 and JI1B differential inputs. In this case, the resistances RSI5, RSI9 for channel I (respectively RSQ5, RSQ9 for channel Q) are connected as short-circuits whereas RSI6, RSI7, RSI8 (respectively RSQ6, RSQ7, RSQ8 for channel Q) are open circuits.

### 8.7.4 Mode select

In order to select the channel you want to evaluate, you must set a jumper on the board in the relevant position for the SELECT pin (see [Figure 31](#)).

The channels selected depend on the position of the jumper:

- With the jumper connected to the upper connectors, channel I at the output is selected.
- With the jumper connected horizontally, channel Q at the output is selected.
- With the jumper connected to the lower connectors, both channels are selected, relative to the clock edge.

**Figure 31. Mode selection**

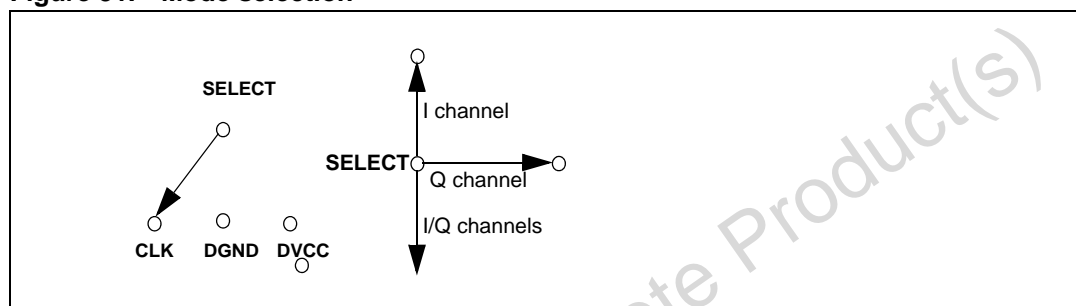



## 9 Practical application examples

### 9.1 Digital interface applications

The wide external buffer power supply range of the TSA1204 makes it a perfect choice for plugging into 2.5 V or 3.3 V low voltage DSPs or digital interfaces.

### 9.2 Medical imaging application

Driven by the demand of the applications requiring nowadays either portability or a high degree of parallelism (or both), this product satisfies the requirements of medical imaging and telecom infrastructures.

The typical system diagram in [Figure 32](#) shows how a narrow input beam of acoustic energy is sent into a living body via the transducer and how the energy reflected back is analyzed.

**Figure 32. Medical imaging application**

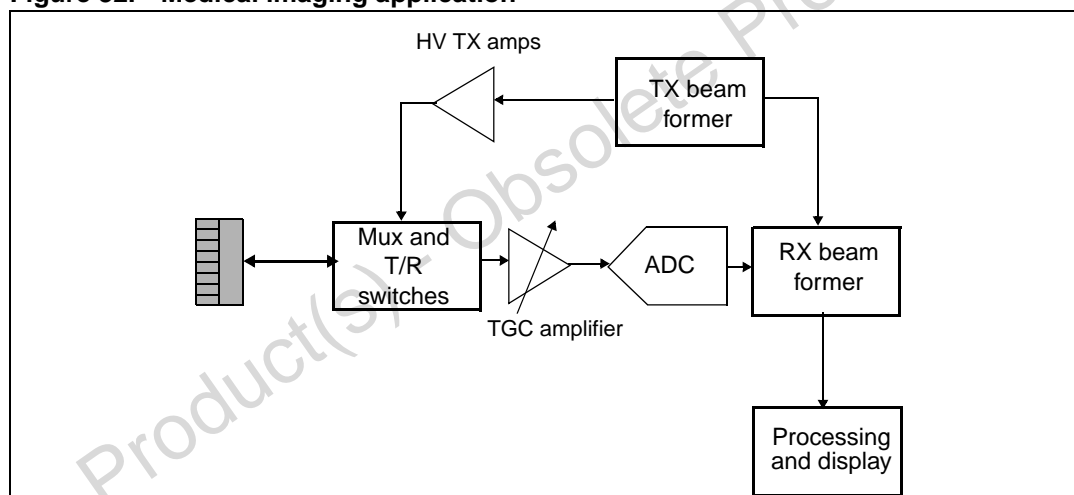

The transducer is a piezoelectric ceramic such as zirconium titanate. The whole array can reach up to 512 channels. The TX beam former, amplified by the HV TX amps, delivers up to 100 V amplitude excitation pulses with phase and amplitude shifts. The mux and T/R switch is a two-way input signal transmitter/output receiver.

To compensate for skin and tissues attenuation effects, the time gain compensation (TGC) amplifier is an exponential amplifier that enables the amplification of low voltage signals to the ADC input range. Differential output structure with low noise and very high linearity are mandatory factors.

These applications need high speed, low power and high performance ADCs. 10-12 bit resolution is necessary to lower the quantification noise. As multiple channels are used, a dual converter is a must for room saving issues.

The input signal is in the range of 2 to 20 MHz (mainly 2 to 7 MHz) and the application uses mostly a 4 over-sampling ratio for spurious free dynamic range (SFDR) optimization.

The next RX beam former and processing blocks enable the analysis of the output channels versus the input beam.

## 10 Definitions of specified parameters

### Static parameters

Static measurements are performed using the histograms method on a 2 MHz input signal, sampled at 50 Msps, which is high enough to fully characterize the test frequency response. The input level is +1 dBFS to saturate the signal.

#### Differential non linearity (DNL)

The average deviation of any output code width from the ideal code width of 1 LSB.

#### Integral non linearity (INL)

An ideal converter exhibits a transfer function which is a straight line from the starting code to the ending code. The INL is the deviation from this ideal line for each transition.

### Dynamic parameters

Dynamic measurements are performed by spectral analysis, applied to an input sine wave of various frequencies sampled at 40 Msps.

The input level is -1dBFS to measure the linear behavior of the converter. All the parameters are given without correction for the full scale amplitude performance except the calculated ENOB parameter.

#### Spurious free dynamic range (SFDR)

The ratio between the power of the worst spurious signal (not always an harmonic) and the amplitude of fundamental tone (signal power) over the full Nyquist band. It is expressed in dBc.

#### Total harmonic distortion (THD)

The ratio of the rms sum of the first five harmonic distortion components to the rms value of the fundamental line. It is expressed in dB.

#### Signal to noise ratio (SNR)

The ratio of the rms value of the fundamental component to the rms sum of all other spectral components in the Nyquist band ( $f_s/2$ ) excluding DC, fundamental and the first five harmonics. SNR is reported in dB.

#### Signal to noise and distortion ratio (SINAD)

Similar ratio as for SNR but including the harmonic distortion components in the noise figure (not DC signal). It is expressed in dB.

The effective number of bits (ENOB) is easily deduced from the SINAD, using the formula:

$$\text{SINAD} = 6.02 \times \text{ENOB} + 1.76 \text{ dB}$$

When the applied signal is not full scale (FS), but has an  $A_0$  amplitude, the SINAD expression becomes:

$$\text{SINAD}_{2A_0} = \text{SINAD}_{\text{Full Scale}} + 20 \log(2A_0/\text{FS})$$

**Definitions of specified parameters****TSA1204**

$$\text{SINAD}_{2A_0} = 6.02 \times \text{ENOB} + 1.76 \text{ dB} + 20 \log(2A_0/\text{FS})$$

The ENOB is expressed in bits.

**Analog input bandwidth**

The maximum analog input frequency at which the spectral response of a full power signal is reduced by 3 dB. Higher values can be achieved with smaller input levels.

**Effective resolution bandwidth (ERB)**

The band of input signal frequencies that the ADC is intended to convert without losing linearity i.e. the maximum analog input frequency at which the SINAD is decreased by 3 dB or the ENOB by 1/2 bit.

**Pipeline delay**

Delay between the initial sample of the analog input and the availability of the corresponding digital data output, on the output bus. Also called data latency. It is expressed as a number of clock cycles.

## 11 Package mechanical data

In order to meet environmental requirements, STMicroelectronics offers these devices in ECOPACK<sup>®</sup> packages. These packages have a Lead-free second level interconnect. The category of second level interconnect is marked on the package and on the inner box label, in compliance with JEDEC Standard JESD97. The maximum ratings related to soldering conditions are also marked on the inner box label. ECOPACK is an STMicroelectronics trademark. ECOPACK specifications are available at: [www.st.com](http://www.st.com).

Obsolete Product(s) - Obsolete Product(s)

Package mechanical data

TSA1204

Figure 33. Package mechanical data (48-pin plastic package)

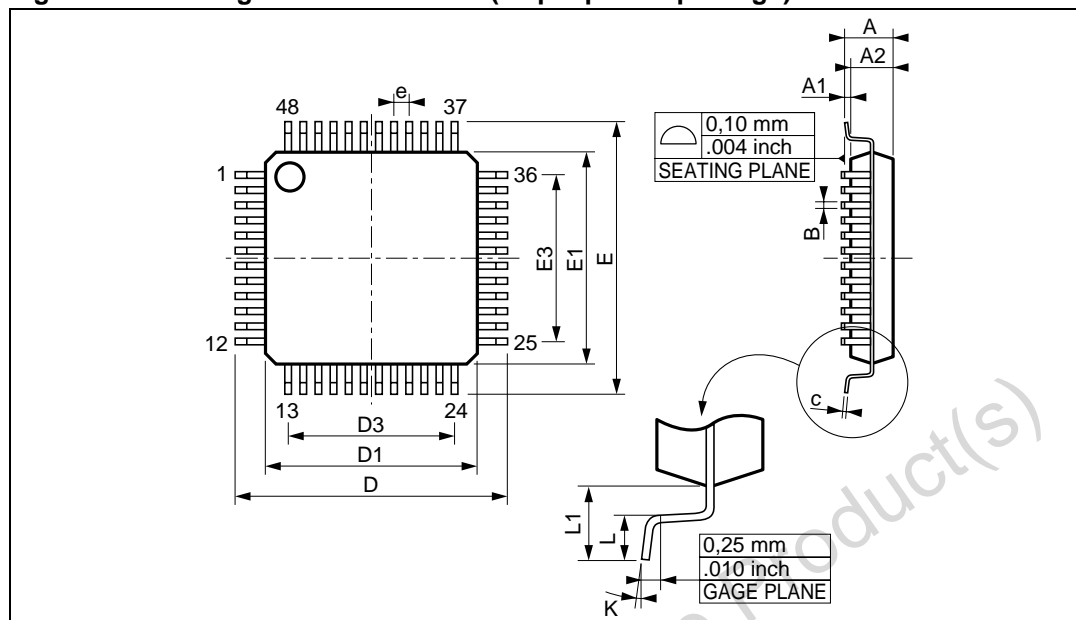

Ref.	Millimeters			Inches		
	Min.	Typ.	Max.	Min.	Typ.	Max.
A			1.60			0.063
A1	0.05		0.15	0.002		0.006
A2	1.35	1.40	1.45	0.053	0.055	0.057
B	0.17	0.22	0.27	0.007	0.009	0.011
C	0.09		0.20	0.004		0.008
D		9.00			0.354	
D1		7.00			0.276	
D3		5.50			0.216	
e		0.50			0.0197	
E		9.00			0.354	
E1		7.00			0.276	
E3		5.50			0.216	
L	0.45	0.60	0.75	0.018	0.024	0.030
L1		1.00			0.039	
K	0° (min.), 7° (max.)					

TSA1204

Ordering information

## 12 Ordering information

Table 15. Order codes

Part number	Temperature range	Package	Packing	Marking
TSA1204IFT-E	-40° C to +85° C	TQFP48	Tape & reel	SA1204I
EVAL1204/BA	Evaluation board			

Obsolete Product(s) - Obsolete Product(s)

## 13 Revision history

Table 16. Document revision history

Date	Revision	Changes
1-Apr-2004	1	Initial release.
2-May-2005	2	Datasheet modified from Not for new Design to full production further to new business demand.
26-Sep-2006	3	Editorial updates. Reorganized document structure. No technical changes.
12-Dec-2006	4	Renamed pin 42 to CLKD.

Obsolete Product(s) - Obsolete Product(s)

## TSA1204

---

### Please Read Carefully:

Information in this document is provided solely in connection with ST products. STMicroelectronics NV and its subsidiaries ("ST") reserve the right to make changes, corrections, modifications or improvements, to this document, and the products and services described herein at any time, without notice.

All ST products are sold pursuant to ST's terms and conditions of sale.

Purchasers are solely responsible for the choice, selection and use of the ST products and services described herein, and ST assumes no liability whatsoever relating to the choice, selection or use of the ST products and services described herein.

No license, express or implied, by estoppel or otherwise, to any intellectual property rights is granted under this document. If any part of this document refers to any third party products or services it shall not be deemed a license grant by ST for the use of such third party products or services, or any intellectual property contained therein or considered as a warranty covering the use in any manner whatsoever of such third party products or services or any intellectual property contained therein.

**UNLESS OTHERWISE SET FORTH IN ST'S TERMS AND CONDITIONS OF SALE ST DISCLAIMS ANY EXPRESS OR IMPLIED WARRANTY WITH RESPECT TO THE USE AND/OR SALE OF ST PRODUCTS INCLUDING WITHOUT LIMITATION IMPLIED WARRANTIES OF MERCHANTABILITY, FITNESS FOR A PARTICULAR PURPOSE (AND THEIR EQUIVALENTS UNDER THE LAWS OF ANY JURISDICTION), OR INFRINGEMENT OF ANY PATENT, COPYRIGHT OR OTHER INTELLECTUAL PROPERTY RIGHT.**

**UNLESS EXPRESSLY APPROVED IN WRITING BY AN AUTHORIZED ST REPRESENTATIVE, ST PRODUCTS ARE NOT RECOMMENDED, AUTHORIZED OR WARRANTED FOR USE IN MILITARY, AIR CRAFT, SPACE, LIFE SAVING, OR LIFE SUSTAINING APPLICATIONS, NOR IN PRODUCTS OR SYSTEMS WHERE FAILURE OR MALFUNCTION MAY RESULT IN PERSONAL INJURY, DEATH, OR SEVERE PROPERTY OR ENVIRONMENTAL DAMAGE. ST PRODUCTS WHICH ARE NOT SPECIFIED AS "AUTOMOTIVE GRADE" MAY ONLY BE USED IN AUTOMOTIVE APPLICATIONS AT USER'S OWN RISK.**

Resale of ST products with provisions different from the statements and/or technical features set forth in this document shall immediately void any warranty granted by ST for the ST product or service described herein and shall not create or extend in any manner whatsoever, any liability of ST.

ST and the ST logo are trademarks or registered trademarks of ST in various countries.

Information in this document supersedes and replaces all information previously supplied.

The ST logo is a registered trademark of STMicroelectronics. All other names are the property of their respective owners.

© 2006 STMicroelectronics - All rights reserved

STMicroelectronics group of companies

Australia - Belgium - Brazil - Canada - China - Czech Republic - Finland - France - Germany - Hong Kong - India - Israel - Italy - Japan - Malaysia - Malta - Morocco - Singapore - Spain - Sweden - Switzerland - United Kingdom - United States of America

[www.st.com](http://www.st.com)