

Excellent Integrated System Limited

Stocking Distributor

Click to view price, real time Inventory, Delivery & Lifecycle Information:

[Fairchild Semiconductor](#)
[FJNS3205RBU](#)

For any questions, you can email us directly:

sales@integrated-circuit.com



FJNS3205R

Switching Application (Bias Resistor Built In)

- Switching circuit, Inverter, Interface circuit, Driver Circuit
- Built in bias Resistor ($R_1=4.7K\Omega$, $R_2=10K\Omega$)
- Complement to FJNS4205R

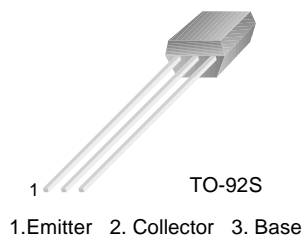

NPN Epitaxial Silicon Transistor

Absolute Maximum Ratings $T_a=25^\circ\text{C}$ unless otherwise noted

| Symbol | Parameter | Value | Units |
|-----------|-----------------------------|-----------|------------------|
| V_{CBO} | Collector-Base Voltage | 50 | V |
| V_{CEO} | Collector-Emitter Voltage | 50 | V |
| V_{EBO} | Emitter-Base Voltage | 10 | V |
| I_C | Collector Current | 100 | mA |
| P_C | Collector Power Dissipation | 300 | mW |
| T_J | Junction Temperature | 150 | $^\circ\text{C}$ |
| T_{STG} | Storage Temperature | -55 ~ 150 | $^\circ\text{C}$ |

Equivalent Circuit

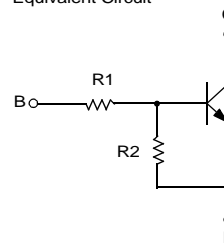

Electrical Characteristics $T_a=25^\circ\text{C}$ unless otherwise noted

| Symbol | Parameter | Test Condition | Min. | Typ. | Max. | Units |
|-------------------|--------------------------------------|---|------|------|------|---------------|
| BV_{CBO} | Collector-Base Breakdown Voltage | $I_C=10\mu\text{A}$, $I_E=0$ | 50 | | | V |
| BV_{CEO} | Collector-Emitter Breakdown Voltage | $I_C=100\mu\text{A}$, $I_B=0$ | 50 | | | V |
| I_{CBO} | Collector Cut-off Current | $V_{CB}=40\text{V}$, $I_E=0$ | | | 0.1 | μA |
| h_{FE} | DC Current Gain | $V_{CE}=5\text{V}$, $I_C=5\text{mA}$ | 30 | | | |
| $V_{CE(sat)}$ | Collector-Emitter Saturation Voltage | $I_C=10\text{mA}$, $I_B=0.5\text{mA}$ | | | 0.3 | V |
| C_{ob} | Output Capacitance | $V_{CE}=10\text{V}$, $I_C=5\text{mA}$ $f=1\text{MHz}$ | | 3.7 | | pF |
| f_T | Current Gain Bandwidth Product | $V_{CE}=10\text{V}$, $I_C=5\text{mA}$ | | 250 | | MHz |
| $V_I(\text{off})$ | Input Off Voltage | $V_{CE}=5\text{V}$, $I_C=100\mu\text{A}$ | 0.3 | | | V |
| $V_I(\text{on})$ | Input On Voltage | $V_{CE}=0.3\text{V}$, $I_C=20\text{mA}$ | | | 2.5 | V |
| R_1 | Input Resistor | | 3.2 | 4.7 | 6.2 | $K\Omega$ |
| R_1/R_2 | Resistor Ratio | | 0.42 | 0.47 | 0.52 | |

Typical Characteristics

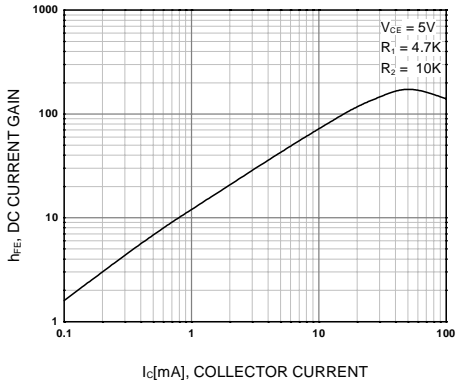

Figure 1. DC current Gain

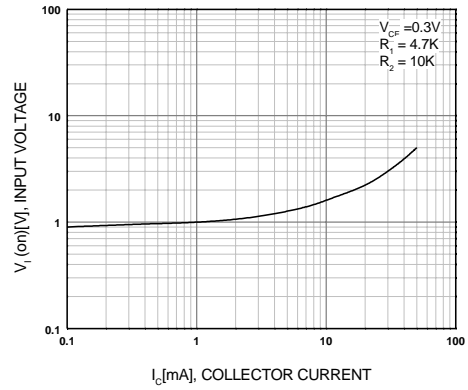

Figure 2. Input On Voltage

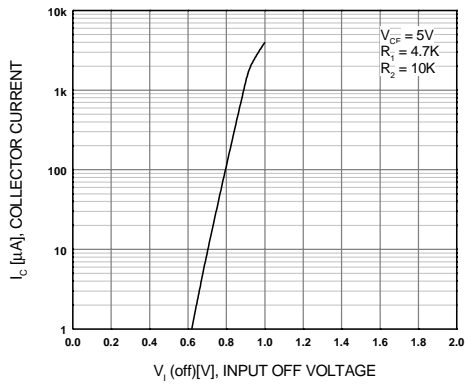

Figure 3. Input Off Voltage

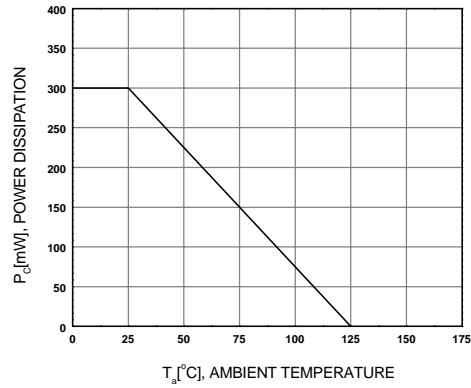
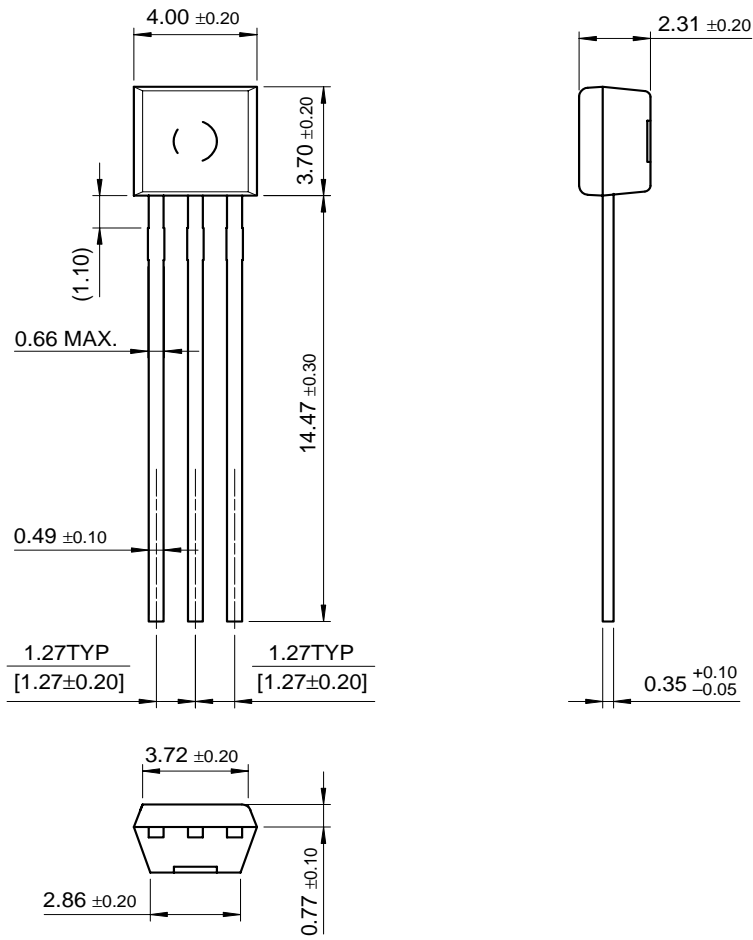

Figure 4. Power Derating

Package Dimensions

TO-92S



Dimensions in Millimeters

TRADEMARKS

The following are registered and unregistered trademarks Fairchild Semiconductor owns or is authorized to use and is not intended to be an exhaustive list of all such trademarks.

| | | | | |
|--------------------------------------|---------------------|--------------------|---------------------|-----------------|
| ACEx™ | FACT™ | ImpliedDisconnect™ | PACMAN™ | SPM™ |
| ActiveArray™ | FACT Quiet Series™ | ISOPLANAR™ | POP™ | Stealth™ |
| Bottomless™ | FAST® | LittleFET™ | Power247™ | SuperSOT™-3 |
| CoolFET™ | FASTr™ | MicroFET™ | PowerTrench® | SuperSOT™-6 |
| CROSSVOLT™ | FRFET™ | MicroPak™ | QFET™ | SuperSOT™-8 |
| DOME™ | GlobalOptoisolator™ | MICROWIRE™ | QS™ | SyncFET™ |
| EcoSPARK™ | GTO™ | MSX™ | QT Optoelectronics™ | TinyLogic™ |
| E ² CMOS™ | HiSeC™ | MSXPro™ | Quiet Series™ | TruTranslation™ |
| EnSigna™ | I ² C™ | OCX™ | RapidConfigure™ | UHC™ |
| Across the board. Around the world.™ | OCXPro™ | OCXPro™ | RapidConnect™ | UltraFET® |
| The Power Franchise™ | OPTOLOGIC® | OPTOLOGIC® | SILENT SWITCHER® | VCX™ |
| Programmable Active Droop™ | OPTOPLANAR™ | OPTOPLANAR™ | SMART START™ | |

DISCLAIMER

FAIRCHILD SEMICONDUCTOR RESERVES THE RIGHT TO MAKE CHANGES WITHOUT FURTHER NOTICE TO ANY PRODUCTS HEREIN TO IMPROVE RELIABILITY, FUNCTION OR DESIGN. FAIRCHILD DOES NOT ASSUME ANY LIABILITY ARISING OUT OF THE APPLICATION OR USE OF ANY PRODUCT OR CIRCUIT DESCRIBED HEREIN; NEITHER DOES IT CONVEY ANY LICENSE UNDER ITS PATENT RIGHTS, NOR THE RIGHTS OF OTHERS.

LIFE SUPPORT POLICY

FAIRCHILD'S PRODUCTS ARE NOT AUTHORIZED FOR USE AS CRITICAL COMPONENTS IN LIFE SUPPORT DEVICES OR SYSTEMS WITHOUT THE EXPRESS WRITTEN APPROVAL OF FAIRCHILD SEMICONDUCTOR CORPORATION. As used herein:

- | | |
|---|---|
| <p>1. Life support devices or systems are devices or systems which, (a) are intended for surgical implant into the body, or (b) support or sustain life, or (c) whose failure to perform when properly used in accordance with instructions for use provided in the labeling, can be reasonably expected to result in significant injury to the user.</p> | <p>2. A critical component is any component of a life support device or system whose failure to perform can be reasonably expected to cause the failure of the life support device or system, or to affect its safety or effectiveness.</p> |
|---|---|

PRODUCT STATUS DEFINITIONS

Definition of Terms

| Datasheet Identification | Product Status | Definition |
|--------------------------|------------------------|---|
| Advance Information | Formative or In Design | This datasheet contains the design specifications for product development. Specifications may change in any manner without notice. |
| Preliminary | First Production | This datasheet contains preliminary data, and supplementary data will be published at a later date. Fairchild Semiconductor reserves the right to make changes at any time without notice in order to improve design. |
| No Identification Needed | Full Production | This datasheet contains final specifications. Fairchild Semiconductor reserves the right to make changes at any time without notice in order to improve design. |
| Obsolete | Not In Production | This datasheet contains specifications on a product that has been discontinued by Fairchild semiconductor. The datasheet is printed for reference information only. |