

Excellent Integrated System Limited

Stocking Distributor

Click to view price, real time Inventory, Delivery & Lifecycle Information:

[ebm-papst Inc.](#)
[DV4114N](#)

For any questions, you can email us directly:

sales@integrated-circuit.com

DV 4114 N

DC diagonal compact fan

sickle-shaped blades (S series)



ebm-papst St. Georgen GmbH & Co. KG

Hermann-Papst-Str. 1
 D-78112 St. Georgen
 Phone +49 (0) 7724 81-0
 Fax +49 (0) 7724 81-1309
info2@de.ebmpapst.com
www.ebmpapst.com

Nominal data

Type	DV 4114 N	
Nominal voltage	VDC	24
Nominal voltage range	VDC	16 .. 30
Speed (rpm)	min ⁻¹	6000
Power consumption	W	20.5
Min. ambient temperature	°C	-20
Max. ambient temperature	°C	65
Air flow	m ³ /h	280
Sound power level	B	6.9
Sound pressure level	dB(A)	61

ml = Max. load · me = Max. efficiency · fa = Free air · cs = Customer specification · ce = Customer equipment
 Subject to change

DV 4114 N

DC diagonal compact fan

sickle-shaped blades (S series)

Technical description

General description	* Power consumption when wide open; these values may be considerably higher at the operating point.
Housing material	Glass-fiber reinforced PBT plastic
Impeller material	Glass-fiber reinforced PA plastic
Weight	0.375 kg
Dimensions	119 x 119 x 38 mm
Airflow direction	Exhaust over struts
Direction of rotation	Counterclockwise, viewed toward rotor
Storage	Ball bearing
Service life L10 at 40 °C	70000 h
Service life L10 at maximum temperature	40000 h
Cable	Leads AWG 22, TR 64, stripped and tin-plated.
Motor protection	Protection against reverse polarity and blocked rotor.
Locked-rotor protection	With electronic locked-rotor and overload protection
Approval	VDE, CSA, UL, CE
Option	Speed signal

DV 4114 N

DC diagonal compact fan
sickle-shaped blades (S series)

Product drawing

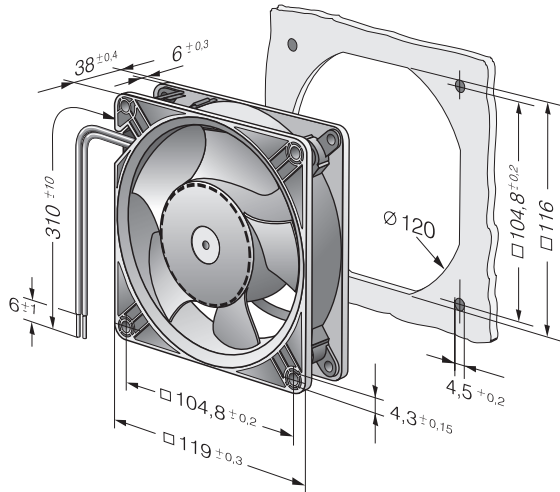

DV 4114 N

DC diagonal compact fan
 sickle-shaped blades (S series)

Curves: Air performance

