

Excellent Integrated System Limited

Stocking Distributor

Click to view price, real time Inventory, Delivery & Lifecycle Information:

[NXP Semiconductors](#)

[MRF6S9125MBR1](#)

For any questions, you can email us directly:

sales@integrated-circuit.com

Freescale Semiconductor
Technical Data

Document Number: MRF6S9125
Rev. 2, 2/2006

Replaced by MRF6S9125NR1/NBR1. There are no form, fit or function changes with this part replacement. N suffix added to part number to indicate transition to lead-free terminations.

RF Power Field Effect Transistors

N-Channel Enhancement-Mode Lateral MOSFETs

Designed for broadband commercial and industrial applications with frequencies up to 1000 MHz. The high gain and broadband performance of these devices make them ideal for large-signal, common-source amplifier applications in 28 volt base station equipment.

N-CDMA Application

- Typical Single-Carrier N-CDMA Performance: $V_{DD} = 28$ Volts, $I_{DQ} = 950$ mA, $P_{out} = 27$ Watt Avg., Full Frequency Band (865-895 MHz), IS-95 CDMA (Pilot, Sync, Paging, Traffic Codes 8 Through 13) Channel Bandwidth = 1.2288 MHz. PAR = 9.8 dB @ 0.01% Probability on CCDF.
Power Gain — 20.2 dB
Drain Efficiency — 31%
ACPR @ 750 kHz Offset = -47.1 dBc @ 30 kHz Bandwidth

GSM EDGE Application

- Typical GSM EDGE Performance: $V_{DD} = 28$ Volts, $I_{DQ} = 700$ mA, $P_{out} = 60$ Watts Avg., Full Frequency Band (865-895 MHz or 921-960 MHz)
Power Gain — 20 dB
Drain Efficiency — 40% (Typ)
Spectral Regrowth @ 400 kHz Offset = -63 dBc
Spectral Regrowth @ 600 kHz Offset = -78 dBc
EVM — 1.5% rms

GSM Application

- Typical GSM Performance: $V_{DD} = 28$ Volts, $I_{DQ} = 700$ mA, $P_{out} = 125$ Watts, Full Frequency Band (921-960 MHz)
Power Gain — 19 dB
Drain Efficiency — 62%
- Capable of Handling 10:1 VSWR, @ 28 Vdc, @ P1dB Output Power, @ f = 880 MHz
- Characterized with Series Equivalent Large-Signal Impedance Parameters
- Internally Matched for Ease of Use
- Qualified Up to a Maximum of 32 V_{DD} Operation
- Integrated ESD Protection
- 200°C Capable Plastic Package
- In Tape and Reel. R1 Suffix = 500 Units per 44 mm, 13 inch Reel.

MRF6S9125MR1
MRF6S9125MBR1

880 MHz, 27 W AVG., 28 V
SINGLE N-CDMA
LATERAL N-CHANNEL
RF POWER MOSFETS

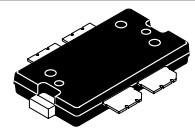

CASE 1486-03, STYLE 1
TO-270 WB-4
PLASTIC
MRF6S9125MR1

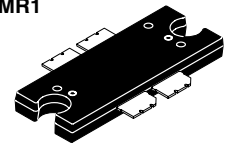

CASE 1484-03, STYLE 1
TO-272 WB-4
PLASTIC
MRF6S9125MBR1

ARCHIVE INFORMATION

ARCHIVE INFORMATION

Table 1. Maximum Ratings

Rating	Symbol	Value	Unit
Drain-Source Voltage	V_{DSS}	-0.5, +68	Vdc
Gate-Source Voltage	V_{GS}	-0.5, +12	Vdc
Total Device Dissipation @ $T_C = 25^\circ\text{C}$ Derate above 25°C	P_D	398 2.3	W W/°C
Storage Temperature Range	T_{stg}	-65 to +150	°C
Operating Junction Temperature	T_J	200	°C

NOTE - CAUTION - MOS devices are susceptible to damage from electrostatic charge. Reasonable precautions in handling and packaging MOS devices should be observed.

Table 2. Thermal Characteristics

Characteristic	Symbol	Value ⁽¹⁾	Unit
Thermal Resistance, Junction to Case Case Temperature 80°C, 125 W CW Case Temperature 76°C, 27 W CW	$R_{\theta JC}$	0.44 0.45	°C/W

Table 3. ESD Protection Characteristics

Test Methodology	Class
Human Body Model (per JESD22-A114)	1B (Minimum)
Machine Model (per EIA/JESD22-A115)	C (Minimum)
Charge Device Model (per JESD22-C101)	IV (Minimum)

Table 4. Moisture Sensitivity Level

Test Methodology	Rating	Package Peak Temperature	Unit
Per JESD 22-A113, IPC/JEDEC J-STD-020	3	260	°C

Table 5. Electrical Characteristics ($T_C = 25^\circ\text{C}$ unless otherwise noted)

Characteristic	Symbol	Min	Typ	Max	Unit
----------------	--------	-----	-----	-----	------

Off Characteristics

Zero Gate Voltage Drain Leakage Current ($V_{DS} = 68\text{ Vdc}$, $V_{GS} = 0\text{ Vdc}$)	I_{DSS}	—	—	10	μAdc
Zero Gate Voltage Drain Leakage Current ($V_{DS} = 28\text{ Vdc}$, $V_{GS} = 0\text{ Vdc}$)	I_{DSS}	—	—	1	μAdc
Gate-Source Leakage Current ($V_{GS} = 5\text{ Vdc}$, $V_{DS} = 0\text{ Vdc}$)	I_{GSS}	—	—	1	μAdc

On Characteristics

Gate Threshold Voltage ($V_{DS} = 10\text{ Vdc}$, $I_D = 400\ \mu\text{Adc}$)	$V_{GS(th)}$	1	2.1	3	Vdc
Gate Quiescent Voltage ($V_{DS} = 28\text{ Vdc}$, $I_D = 950\text{ mAdc}$)	$V_{GS(Q)}$	2	2.89	4	Vdc
Drain-Source On-Voltage ($V_{GS} = 10\text{ Vdc}$, $I_D = 2.74\text{ Adc}$)	$V_{DS(on)}$	0.05	0.23	0.3	Vdc
Forward Transconductance ($V_{DS} = 10\text{ Vdc}$, $I_D = 8\text{ Adc}$)	g_{fs}	—	6	—	S

Dynamic Characteristics ⁽²⁾

Output Capacitance ($V_{DS} = 28\text{ Vdc} \pm 30\text{ mV(rms)ac}$ @ 1 MHz, $V_{GS} = 0\text{ Vdc}$)	C_{oss}	—	60	—	pF
Reverse Transfer Capacitance ($V_{DS} = 28\text{ Vdc} \pm 30\text{ mV(rms)ac}$ @ 1 MHz, $V_{GS} = 0\text{ Vdc}$)	C_{rss}	—	2	—	pF

Functional Tests (In Freescale Test Fixture, 50 ohm system) $V_{DD} = 28\text{ Vdc}$, $I_{DQ} = 950\text{ mA}$, $P_{out} = 27\text{ W}$, $f = 880\text{ MHz}$

Power Gain	G_{ps}	19	20.2	24	dB
Drain Efficiency	η_D	29	31	—	%
Adjacent Channel Power Ratio	ACPR	—	-47.1	-45	dBc
Input Return Loss	IRL	—	-16	-9	dB

1. Refer to AN1955, *Thermal Measurement Methodology of RF Power Amplifiers*. Go to <http://www.freescale.com/rf>.
Select Documentation/Application Notes - AN1955.
2. Part is internally input matched.

(continued)

Table 5. Electrical Characteristics ($T_C = 25^\circ\text{C}$ unless otherwise noted) **(continued)**

Characteristic	Symbol	Min	Typ	Max	Unit
----------------	--------	-----	-----	-----	------

Typical GSM EDGE Performances (In Freescale GSM EDGE Test Fixture, 50 ohm system) $V_{DD} = 28\text{ Vdc}$, $I_{DQ} = 950\text{ mA}$, $P_{out} = 60\text{ W Avg.}$, 921 MHz < Frequency < 960 MHz

Power Gain	G_{ps}	—	20	—	dB
Drain Efficiency	η_D	—	40	—	%
Error Vector Magnitude	EVM	—	1.5	—	% rms
Spectral Regrowth at 400 kHz Offset	SR1	—	-63	—	dBc
Spectral Regrowth at 600 kHz Offset	SR2	—	-78	—	dBc

Typical CW Performances (In Freescale GSM Test Fixture, 50 ohm system) $V_{DD} = 28\text{ Vdc}$, $I_{DQ} = 700\text{ mA}$, $P_{out} = 125\text{ W}$, 921 MHz < Frequency < 960 MHz

Power Gain	G_{ps}	—	19	—	dB
Drain Efficiency	η_D	—	62	—	%
Input Return Loss	IRL	—	-12	—	dB
P_{out} @ 1 dB Compression Point, CW ($f = 880\text{ MHz}$)	P1dB	—	125	—	W

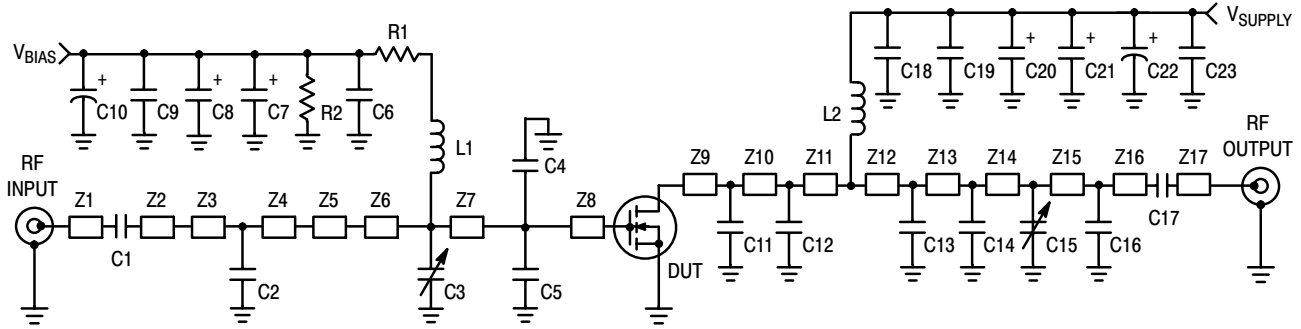

Z1, Z17	0.200" x 0.080" Microstrip	Z10	0.057" x 0.620" Microstrip
Z2	1.060" x 0.080" Microstrip	Z11	0.119" x 0.620" Microstrip
Z3	0.382" x 0.220" Microstrip	Z12	0.450" x 0.220" Microstrip
Z4	0.108" x 0.220" Microstrip	Z13	0.061" x 0.220" Microstrip
Z5	0.200" x 0.420" x 0.620" Taper	Z14	0.078" x 0.220" Microstrip
Z6	0.028" x 0.620" Microstrip	Z15	0.692" x 0.080" Microstrip
Z7	0.236" x 0.620" Microstrip	Z16	0.368" x 0.080" Microstrip
Z8	0.050" x 0.620" Microstrip	Z17	0.368" x 0.080" Microstrip
Z9	0.238" x 0.620" Microstrip	PCB	Arlon GX-0300-55-22, 0.030", $\epsilon_r = 2.55$

Figure 1. MRF6S9125MR1(MBR1) Test Circuit Schematic

Table 6. MRF6S9125MR1(MBR1) Test Circuit Component Designations and Values

Part	Description	Part Number	Manufacturer
C1	20 pF Chip Capacitor	600B200FT250XT	ATC
C2	6.2 pF Chip Capacitor	600B6R2BT250XT	ATC
C3, C15	0.8-8.0 pF Variable Capacitors, Gigatrim	27291SL	Johanson
C4, C5	11 pF Chip Capacitors	600B110FT250XT	ATC
C6, C18, C19	0.56 μ F, 50 V Chip Capacitors	C1825C564J5RAC	Kemet
C7, C8	47 μ F, 16 V Tantalum Capacitors	593D476X9016D2T	Vishay
C9, C23	47 pF Chip Capacitors	700B470FW500XT	ATC
C10	100 μ F, 50 V Electrolytic Capacitor	515D107M050BB6A	Vishay
C11, C12	12 pF Chip Capacitors	600B120FT250XT	ATC
C13, C14	5.1 pF Chip Capacitors	600B5R1BT250XT	ATC
C16	0.3 pF Chip Capacitor	700B0R3BW500XT	ATC
C17	39 pF Chip Capacitor	700B390FW500XT	ATC
C20, C21	22 μ F, 35 V Tantalum Capacitors	T491X226K035AS	Kemet
C22	470 μ F, 63 V Electrolytic Capacitor	SME63V471M12X25LL	United Chemi-Con
L1	7.15 nH Inductor	1606-7J	CoilCraft
L2	8.0 nH Inductor	A03T	CoilCraft
R1	15 Ω , 1/4 W Chip Resistor (1210)		Dale/Vishay
R2	560 k Ω , 1/8 W Resistor (1206)		Dale/Vishay

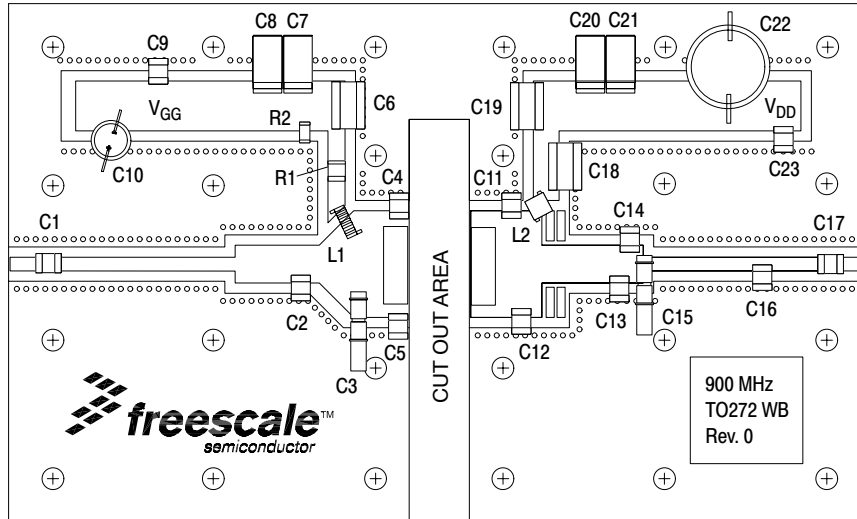

Figure 2. MRF6S9125MR1 (MBR1) Test Circuit Component Layout

ARCHIVE INFORMATION

ARCHIVE INFORMATION

TYPICAL CHARACTERISTICS

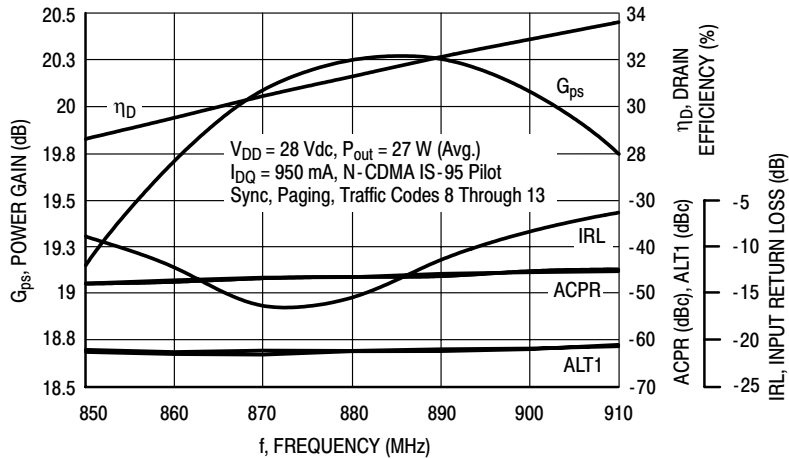

Figure 3. Single-Carrier N-CDMA Broadband Performance @ $P_{out} = 27$ Watts Avg.

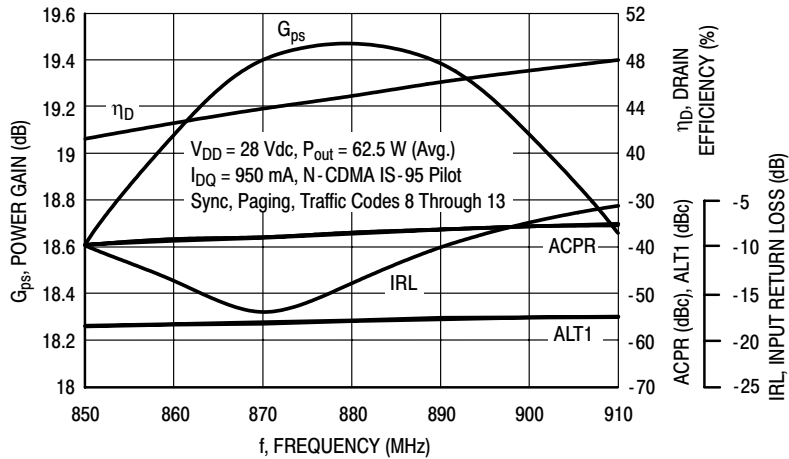

Figure 4. Single-Carrier N-CDMA Broadband Performance @ $P_{out} = 62.5$ Watts Avg.

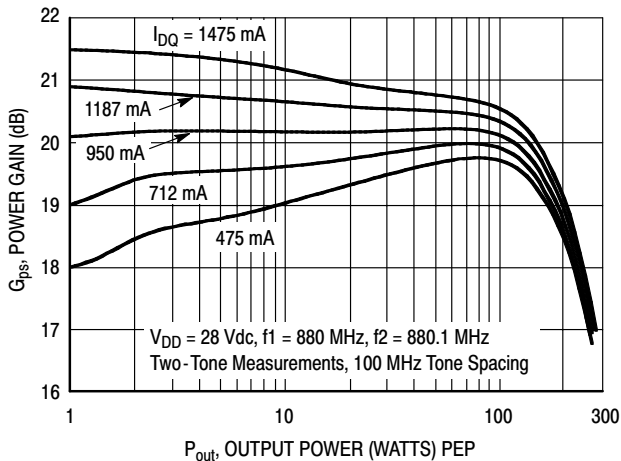

Figure 5. Two-Tone Power Gain versus Output Power

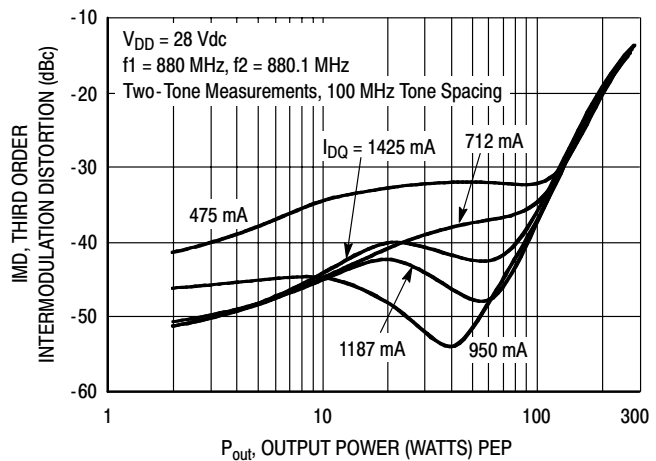

Figure 6. Third Order Intermodulation Distortion versus Output Power

TYPICAL CHARACTERISTICS

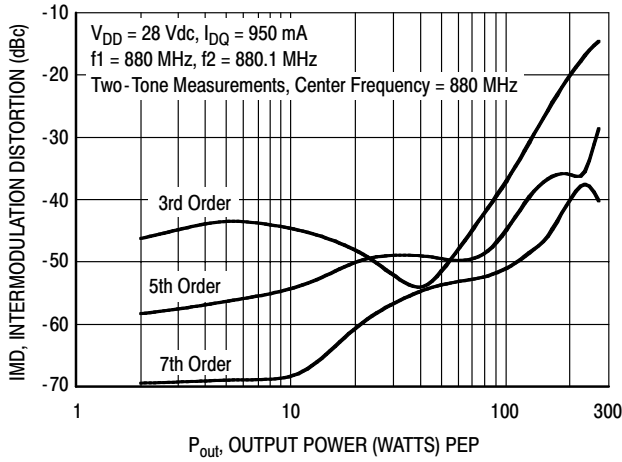

Figure 7. Intermodulation Distortion Products versus Output Power

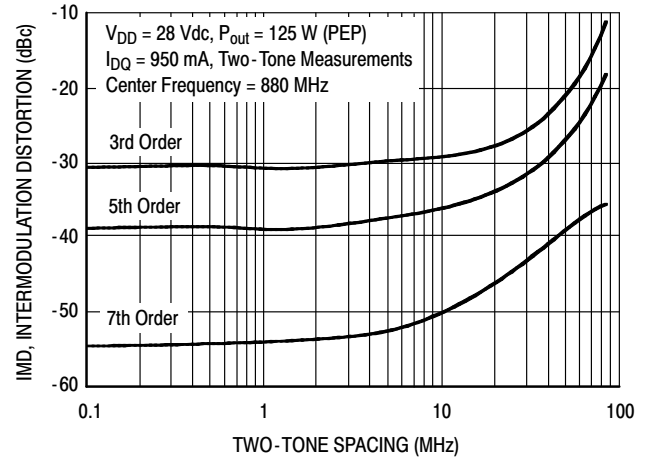

Figure 8. Intermodulation Distortion Products versus Tone Spacing

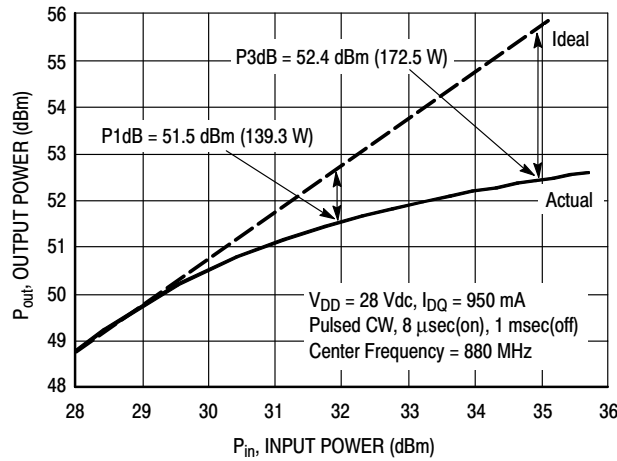

Figure 9. Pulse CW Output Power versus Input Power

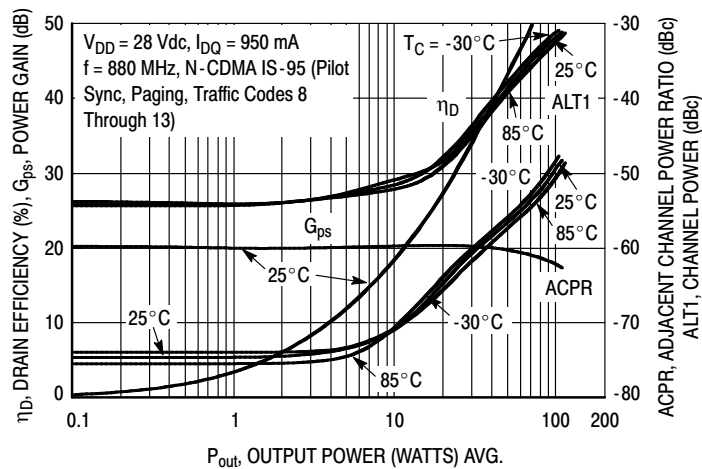

Figure 10. Single-Carrier N-CDMA ACPR, ALT1, Power Gain and Drain Efficiency versus Output Power

ARCHIVE INFORMATION

ARCHIVE INFORMATION

TYPICAL CHARACTERISTICS

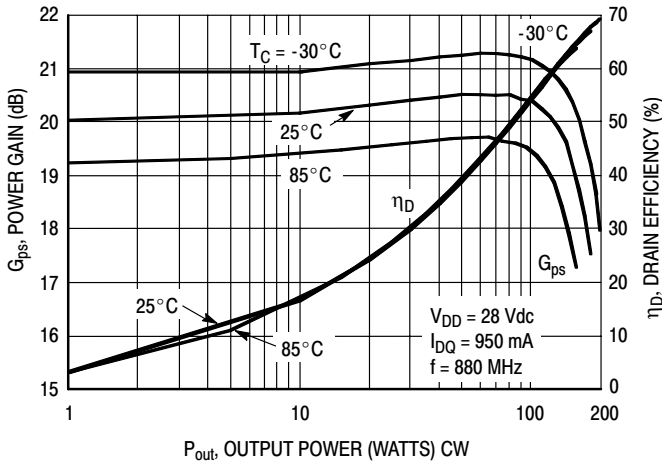

Figure 11. Power Gain and Drain Efficiency versus CW Output Power

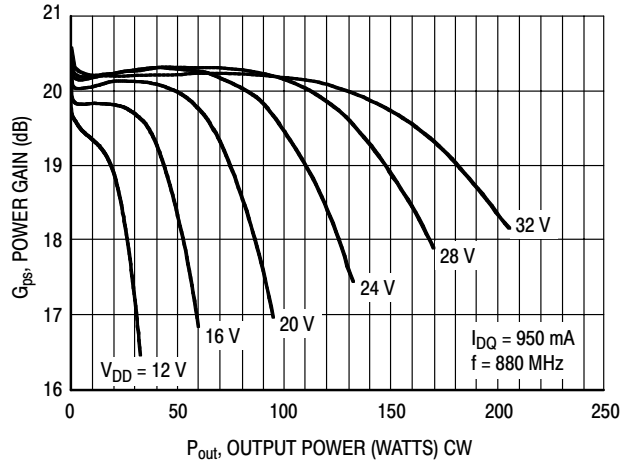
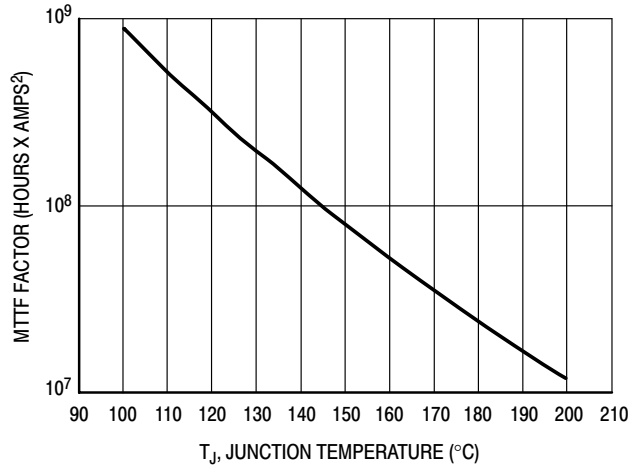

Figure 12. Power Gain versus Output Power



This above graph displays calculated MTTF in hours x ampere² drain current. Life tests at elevated temperatures have correlated to better than ±10% of the theoretical prediction for metal failure. Divide MTTF factor by I_D² for MTTF in a particular application.

Figure 13. MTTF Factor versus Junction Temperature

ARCHIVE INFORMATION

ARCHIVE INFORMATION

N-CDMA TEST SIGNAL

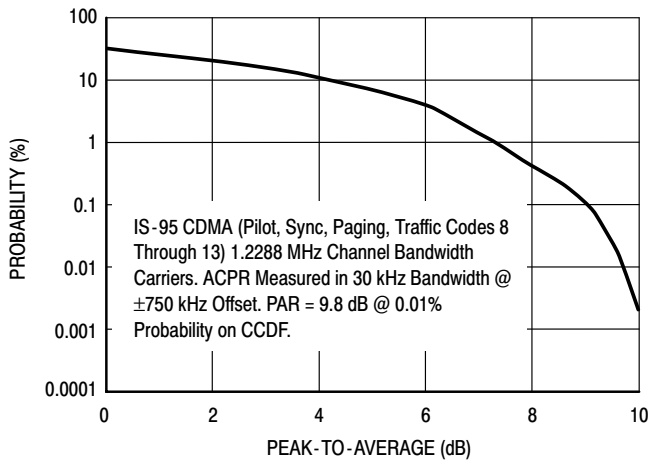

Figure 14. Single-Carrier CCDF N-CDMA

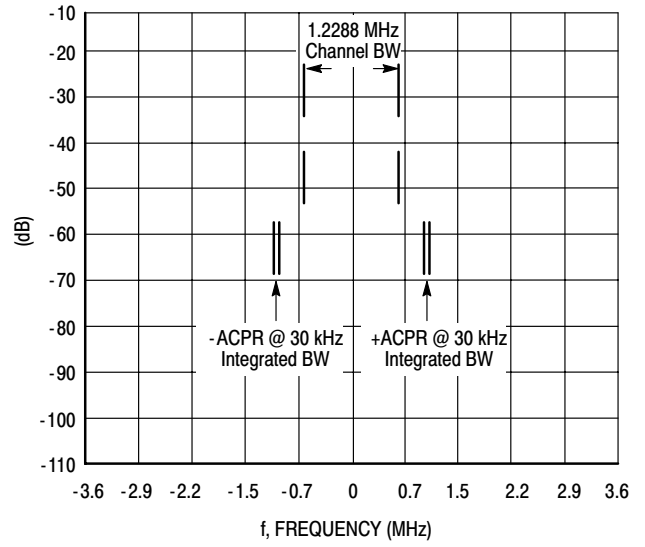

Figure 15. Single-Carrier N-CDMA Spectrum

ARCHIVE INFORMATION

ARCHIVE INFORMATION

ARCHIVE INFORMATION

ARCHIVE INFORMATION

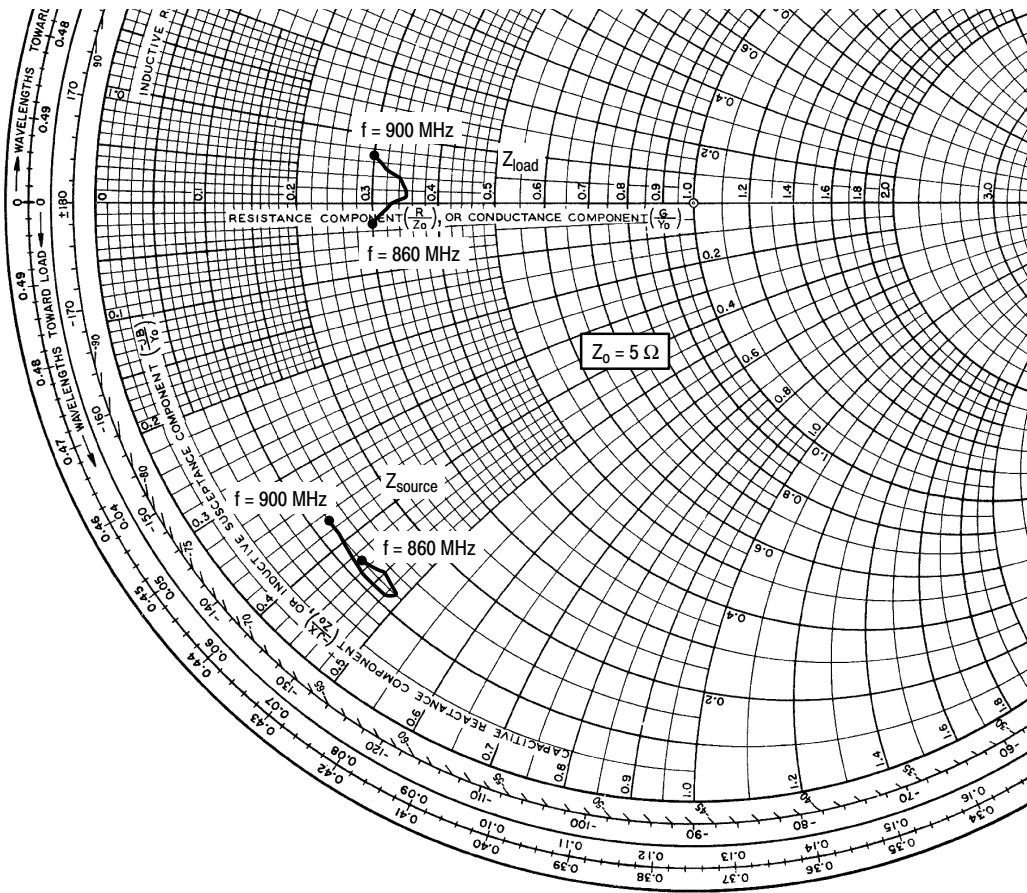

$V_{DD} = 28 \text{ Vdc}$, $I_{DQ} = 950 \text{ mA}$, $P_{out} = 27 \text{ W Avg.}$

f MHz	Z_{source} Ω	Z_{load} Ω
860	$0.62 - j2.13$	$1.48 - j0.14$
865	$0.64 - j2.31$	$1.56 - j0.09$
870	$0.62 - j2.45$	$1.66 - j0.02$
875	$0.59 - j2.43$	$1.73 + j0.04$
880	$0.57 - j2.42$	$1.74 + j0.11$
885	$0.54 - j2.36$	$1.68 + j0.19$
890	$0.57 - j2.18$	$1.61 + j0.25$
895	$0.58 - j1.94$	$1.52 + j0.33$
900	$0.59 - j1.86$	$1.48 + j0.37$

Z_{source} = Test circuit impedance as measured from gate to ground.

Z_{load} = Test circuit impedance as measured from drain to ground.

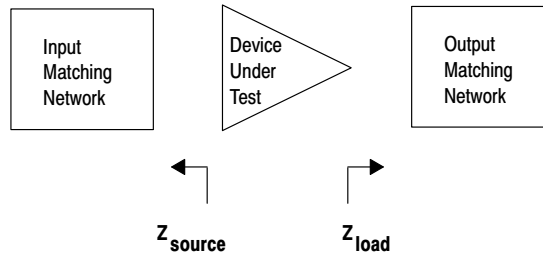
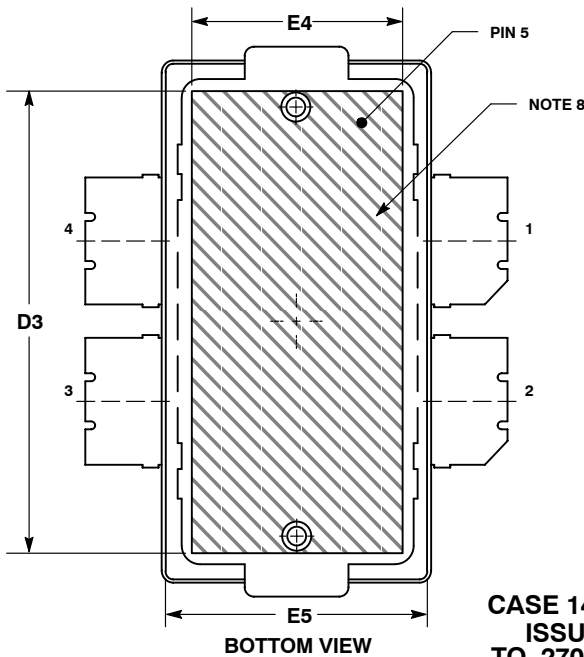
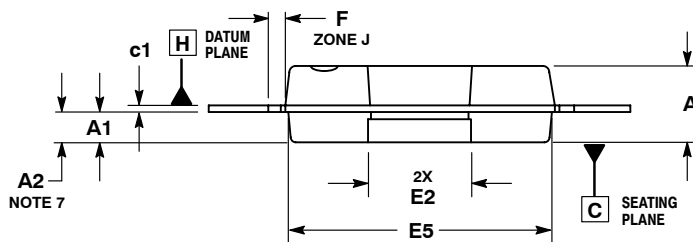
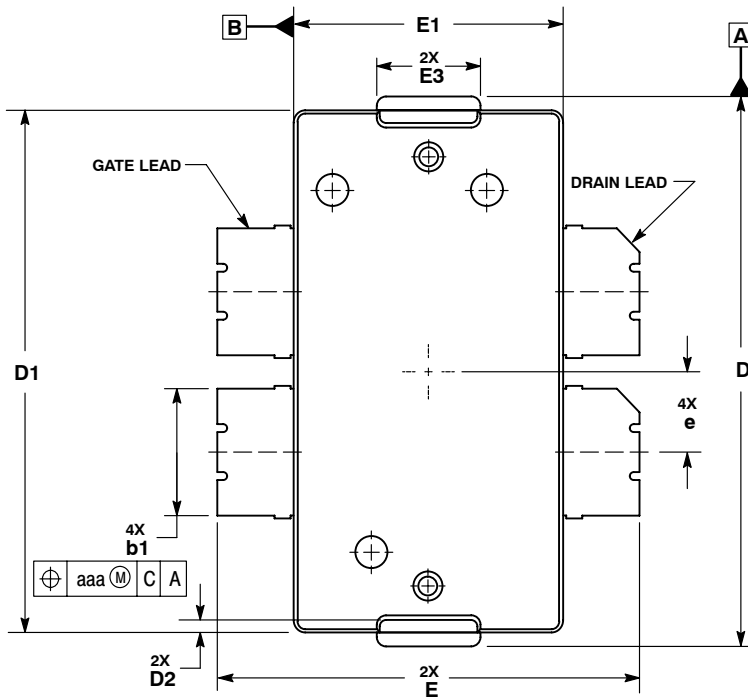

Figure 16. Series Equivalent Source and Load Impedance

NOTES

PACKAGE DIMENSIONS



NOTES:

1. CONTROLLING DIMENSION: INCH.
2. INTERPRET DIMENSIONS AND TOLERANCES PER ASME Y14.5M-1994.
3. DATUM PLANE -H- IS LOCATED AT THE TOP OF LEAD AND IS COINCIDENT WITH THE LEAD WHERE THE LEAD EXITS THE PLASTIC BODY AT THE TOP OF THE PARTING LINE.
4. DIMENSIONS "D" AND "E1" DO NOT INCLUDE MOLD PROTRUSION. ALLOWABLE PROTRUSION IS .006 PER SIDE. DIMENSIONS "D" AND "E1" DO INCLUDE MOLD MISMATCH AND ARE DETERMINED AT DATUM PLANE -H-.
5. DIMENSION "b1" DOES NOT INCLUDE DAMBAR PROTRUSION. ALLOWABLE DAMBAR PROTRUSION SHALL BE .005 TOTAL IN EXCESS OF THE "b1" DIMENSION AT MAXIMUM MATERIAL CONDITION.
6. DATUMS -A- AND -B- TO BE DETERMINED AT DATUM PLANE -H-.
7. DIMENSION A2 APPLIES WITHIN ZONE "J" ONLY.
8. HATCHING REPRESENTS THE EXPOSED AREA OF THE HEAT SLUG.

DIM	INCHES		MILLIMETERS	
	MIN	MAX	MIN	MAX
A	.100	.104	2.54	2.64
A1	.039	.043	0.99	1.09
A2	.040	.042	1.02	1.07
D	.712	.720	18.08	18.29
D1	.688	.692	17.48	17.58
D2	.011	.019	0.28	0.48
D3	.600	---	15.24	---
E	.551	.559	14	14.2
E1	.353	.357	8.97	9.07
E2	.132	.140	3.35	3.56
E3	.124	.132	3.15	3.35
E4	.270	---	6.86	---
E5	.346	.350	8.79	8.89
F	.025 BSC		0.64 BSC	
b1	.164	.170	4.17	4.32
c1	.007	.011	0.18	0.28
e	.106 BSC		2.69 BSC	
aaa	.004		0.10	

STYLE 1:

1. DRAIN
2. DRAIN
3. GATE
4. GATE
5. SOURCE

CASE 1486-03
ISSUE C
TO-270 WB-4
PLASTIC
MRF6S9125MR1

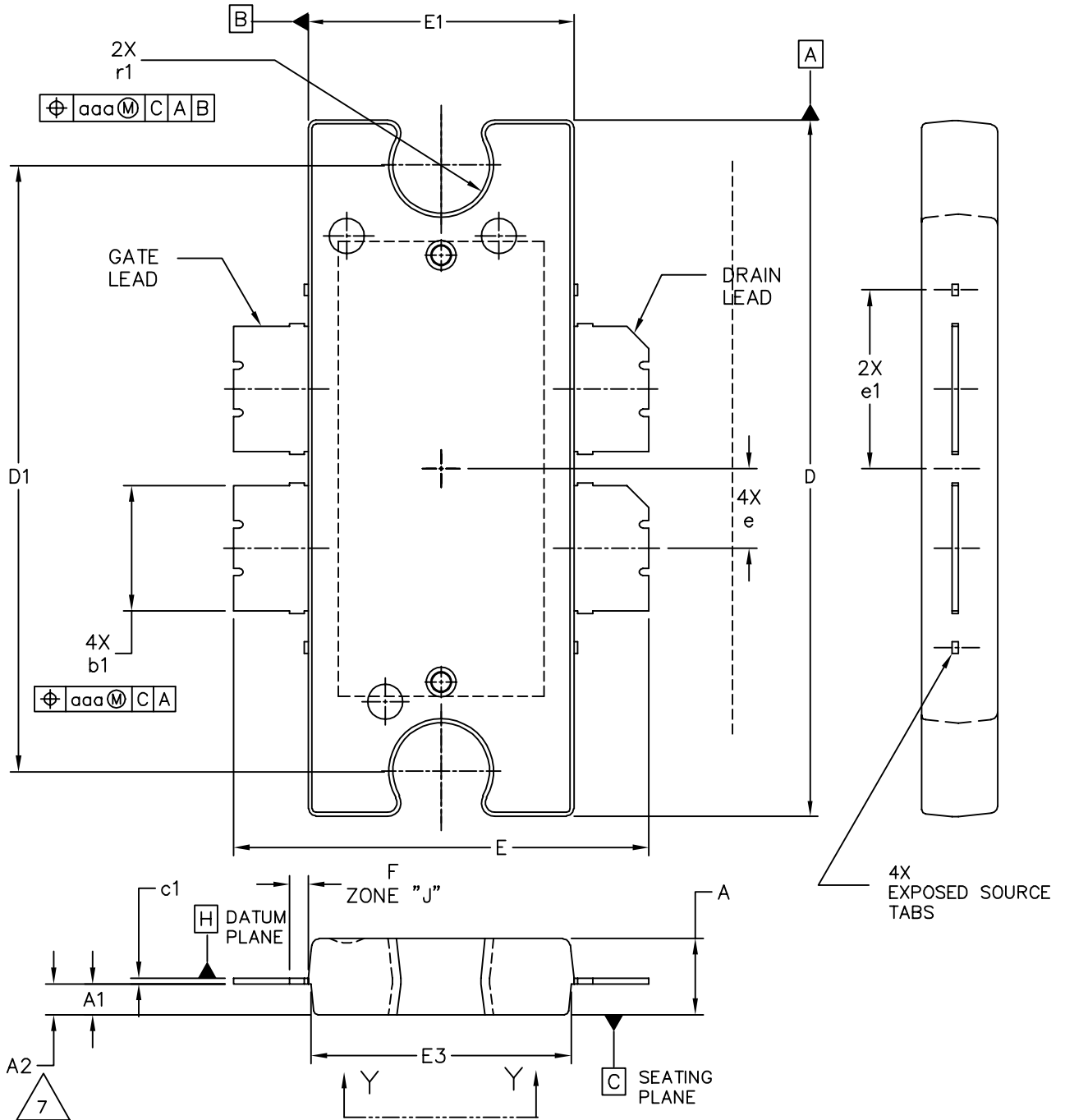

© FREESCALE SEMICONDUCTOR, INC. ALL RIGHTS RESERVED.	MECHANICAL OUTLINE		PRINT VERSION NOT TO SCALE	
			DOCUMENT NO: 98ASA10575D	REV: C
TITLE: TO-272 4 LEAD, WIDE BODY	CASE NUMBER: 1484-03		01 DEC 2005	
	STANDARD: NON-JEDEC			

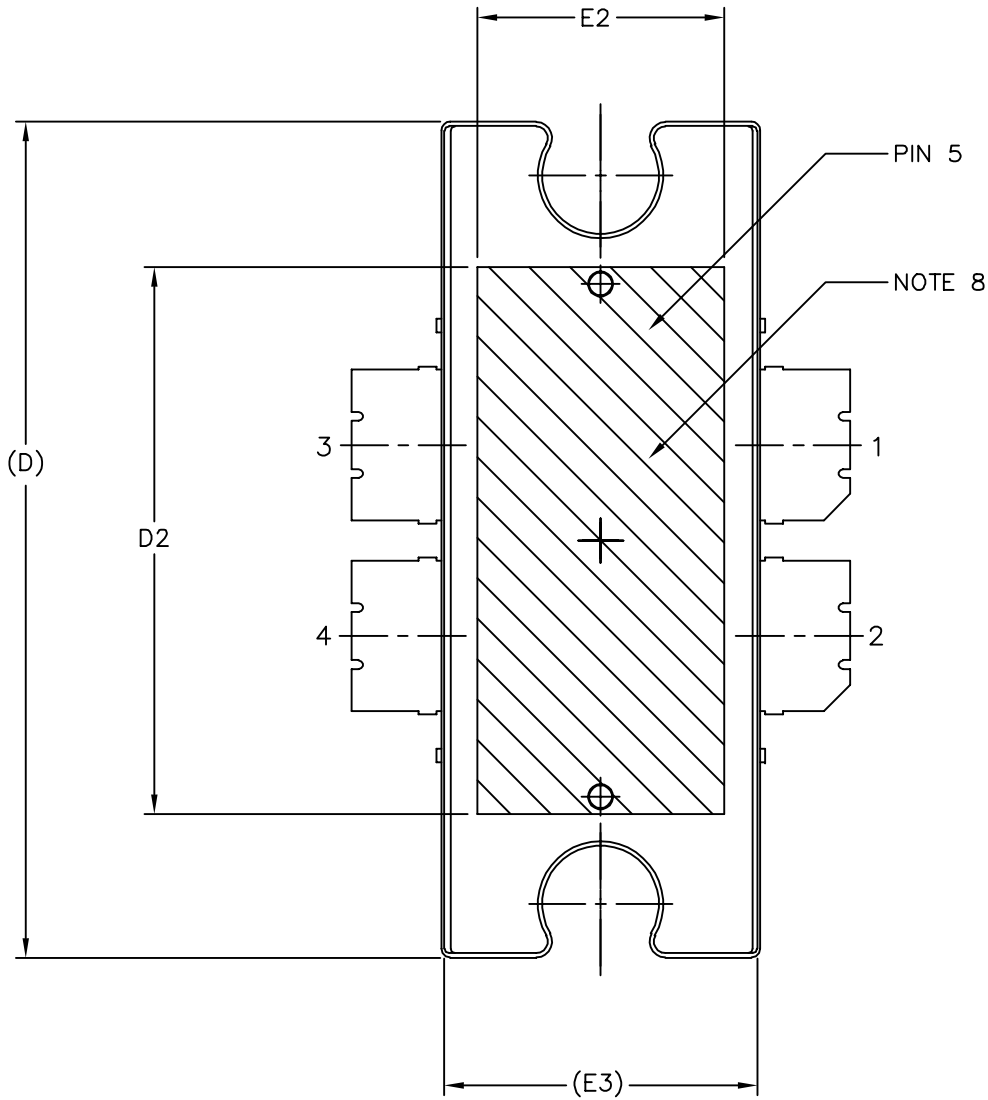

© FREESCALE SEMICONDUCTOR, INC. ALL RIGHTS RESERVED.	MECHANICAL OUTLINE	PRINT VERSION NOT TO SCALE	
TITLE: TO-272 4 LEAD, WIDE BODY	DOCUMENT NO: 98ASA10575D	REV: C	
	CASE NUMBER: 1484-03	01 DEC 2005	
	STANDARD: NON-JEDEC		

NOTES:

1. CONTROLLING DIMENSION: INCH
2. INTERPRET DIMENSIONS AND TOLERANCES PER ASME Y14.5M-1994.
3. DATUM PLANE -H- IS LOCATED AT THE TOP OF LEAD AND IS COINCIDENT WITH THE LEAD WHERE THE LEAD EXITS THE PLASTIC BODY AT THE TOP OF THE PARTING LINE.
4. DIMENSIONS "D" AND "E1" DO NOT INCLUDE MOLD PROTRUSION. ALLOWABLE PROTRUSION IS .006 PER SIDE. DIMENSIONS "D" AND "E1" DO INCLUDE MOLD MISMATCH AND ARE DETERMINED AT DATUM PLANE -H-.
5. DIMENSIONS "b1" DOES NOT INCLUDE DAMBAR PROTRUSION. ALLOWABLE DAMBAR PROTRUSION SHALL BE .005 TOTAL IN EXCESS OF THE "b1" DIMENSION AT MAXIMUM MATERIAL CONDITION.
6. DATUMS -A- AND -B- TO BE DETERMINED AT DATUM PLANE -H-.
7. DIMENSION A2 APPLIES WITHIN ZONE "J" ONLY.
8. HATCHING REPRESENTS THE EXPOSED AREA OF THE HEAT SLUG.

STYLE 1:

PIN 1 - DRAIN PIN 2 - DRAIN
 PIN 3 - GATE PIN 4 - GATE
 PIN 5 - SOURCE

DIM	INCH		MILLIMETER		DIM	INCH		MILLIMETER	
	MIN	MAX	MIN	MAX		MIN	MAX	MIN	MAX
A	.100	.104	2.54	2.64	b1	.164	.170	4.17	4.32
A1	.039	.043	0.99	1.09	c1	.007	.011	.18	.28
A2	.040	.042	1.02	1.07	r1	.063	.068	1.60	1.73
D	.928	.932	23.57	23.67	e	.106 BSC		2.69 BSC	
D1	.810 BSC		20.57 BSC		e1	.239 INFO ONLY		6.07 INFO ONLY	
D2	.600	---	15.24	---	aaa	.004		.10	
E	.551	.559	14	14.2					
E1	.353	.357	8.97	9.07					
E2	.270	---	6.86	---					
E3	.346	.350	8.79	8.89					
F	.025 BSC		0.64 BSC						

© FREESCALE SEMICONDUCTOR, INC. ALL RIGHTS RESERVED.		MECHANICAL OUTLINE		PRINT VERSION NOT TO SCALE	
TITLE: TO-272 4 LEAD WIDE BODY		DOCUMENT NO: 98ASA10575D		REV: C	
		CASE NUMBER: 1484-03		01 DEC 2005	
		STANDARD: NON-JEDEC			

How to Reach Us:

Home Page:

www.freescale.com

E-mail:

support@freescale.com

USA/Europe or Locations Not Listed:

Freescale Semiconductor
 Technical Information Center, CH370
 1300 N. Alma School Road
 Chandler, Arizona 85224
 +1-800-521-6274 or +1-480-768-2130
support@freescale.com

Europe, Middle East, and Africa:

Freescale Halbleiter Deutschland GmbH
 Technical Information Center
 Schatzbogen 7
 81829 Muenchen, Germany
 +44 1296 380 456 (English)
 +46 8 52200080 (English)
 +49 89 92103 559 (German)
 +33 1 69 35 48 48 (French)
support@freescale.com

Japan:

Freescale Semiconductor Japan Ltd.
 Headquarters
 ARCO Tower 15F
 1-8-1, Shimo-Meguro, Meguro-ku,
 Tokyo 153-0064
 Japan
 0120 191014 or +81 3 5437 9125
support.japan@freescale.com

Asia/Pacific:

Freescale Semiconductor Hong Kong Ltd.
 Technical Information Center
 2 Dai King Street
 Tai Po Industrial Estate
 Tai Po, N.T., Hong Kong
 +800 2666 8080
support.asia@freescale.com

For Literature Requests Only:

Freescale Semiconductor Literature Distribution Center
 P.O. Box 5405
 Denver, Colorado 80217
 1-800-441-2447 or 303-675-2140
 Fax: 303-675-2150
LDCForFreescaleSemiconductor@hibbertgroup.com

Information in this document is provided solely to enable system and software implementers to use Freescale Semiconductor products. There are no express or implied copyright licenses granted hereunder to design or fabricate any integrated circuits or integrated circuits based on the information in this document.

Freescale Semiconductor reserves the right to make changes without further notice to any products herein. Freescale Semiconductor makes no warranty, representation or guarantee regarding the suitability of its products for any particular purpose, nor does Freescale Semiconductor assume any liability arising out of the application or use of any product or circuit, and specifically disclaims any and all liability, including without limitation consequential or incidental damages. "Typical" parameters that may be provided in Freescale Semiconductor data sheets and/or specifications can and do vary in different applications and actual performance may vary over time. All operating parameters, including "Typicals", must be validated for each customer application by customer's technical experts. Freescale Semiconductor does not convey any license under its patent rights nor the rights of others. Freescale Semiconductor products are not designed, intended, or authorized for use as components in systems intended for surgical implant into the body, or other applications intended to support or sustain life, or for any other application in which the failure of the Freescale Semiconductor product could create a situation where personal injury or death may occur. Should Buyer purchase or use Freescale Semiconductor products for any such unintended or unauthorized application, Buyer shall indemnify and hold Freescale Semiconductor and its officers, employees, subsidiaries, affiliates, and distributors harmless against all claims, costs, damages, and expenses, and reasonable attorney fees arising out of, directly or indirectly, any claim of personal injury or death associated with such unintended or unauthorized use, even if such claim alleges that Freescale Semiconductor was negligent regarding the design or manufacture of the part.

Freescale™ and the Freescale logo are trademarks of Freescale Semiconductor, Inc. All other product or service names are the property of their respective owners.
 © Freescale Semiconductor, Inc. 2006. All rights reserved.

RoHS-compliant and/or Pb-free versions of Freescale products have the functionality and electrical characteristics of their non-RoHS-compliant and/or non-Pb-free counterparts. For further information, see <http://www.freescale.com> or contact your Freescale sales representative.

For information on Freescale's Environmental Products program, go to <http://www.freescale.com/ep>.