

Excellent Integrated System Limited

Stocking Distributor

Click to view price, real time Inventory, Delivery & Lifecycle Information:

[BUD Industries, Inc.](#)
[CN-5703](#)

For any questions, you can email us directly:

sales@integrated-circuit.com

THE INFORMATION CONTAINED IN THIS DRAWING IS THE SOLE PROPERTY OF BUD INDUSTRIES INC. ANY REPRODUCTION IN PART OR WHOLE WITHOUT THE WRITTEN PERMISSION OF BUD INDUSTRIES INC. IS PROHIBITED.

CN-5703	
ISSUE	REVISIONS

MATERIAL - ALUMINUM ALLOY #ADC-12
 FINISH - NATURAL (CONTACT BUD FACTORY FOR ALTERNATE FINISHES)
 GASKET - RATED IP65 NEOPRENE, SELF-ADHESIVE, 3mm THICK, COLOR BLACK
 SCREWS - STAINLESS STEEL, M3.5 x 12mm LG., CSK. HEAD, SELF-THREADING

ALL HOLE DIAMETERS HAVE ±.005 TOLERANCE.
 ALL OTHER DIMENSIONS HAVE ±.015 TOLERANCE.
 ENCLOSURES ARE SHIPPED UNASSEMBLED WITH ALL ITEMS SHOWN.

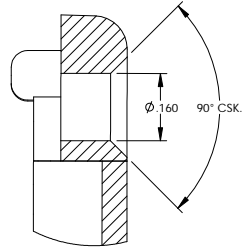
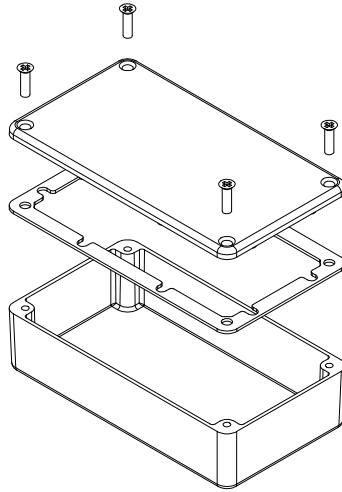

DETAIL D
SCALE 6 : 1

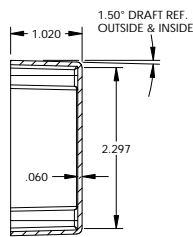
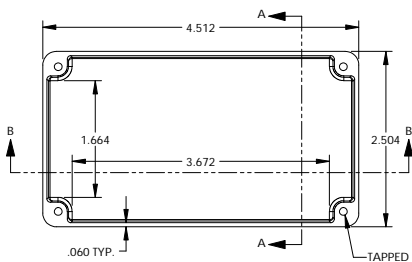

BODY

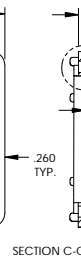
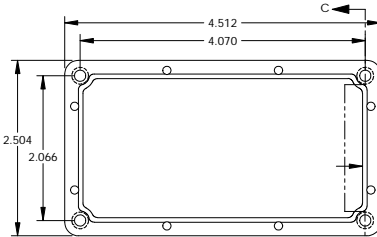

COVER

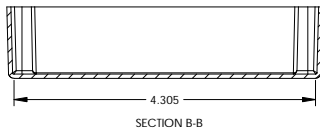
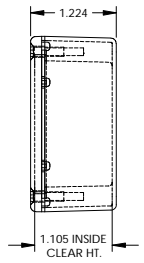

SECTION B-B

PARTS LIST			
✓.005 BETWEEN HOLE CENTERS	✓.010 BETWEEN HOLE EDGES	✓.010 FROM A BENT SURFACE	✓.010 BETWEEN ASSEMBLED SURFACES
UNLESS OTHERWISE SPECIFIED MATERIAL:	AS NOTED	APPROVED:	DATE:
DESIGN:	AS NOTED	DESIGNED:	3-31-06
BUD INDUSTRIES INC.		DIE CAST ALUMINUM ENCLOSURE	
CN-5703		CN-5703	

QTY:	USED ON:	DO NOT SCALE DRAWING:	SCALE:	CAD FILE:	DELT:	OF: