

Excellent Integrated System Limited

Stocking Distributor

Click to view price, real time Inventory, Delivery & Lifecycle Information:

[NXP Semiconductors/Freescale Semiconductor, Inc.](#)
[BTA201W-800E,115](#)

For any questions, you can email us directly:

sales@integrated-circuit.com



BTA201W-800E

3Q Hi-Com triac

13 August 2014

Product data sheet

1. General description

Planar passivated high commutation triac in a SOT223 surface mounted plastic package. This "series E" triac balances the requirements of commutation performance and gate sensitivity and is intended for interfacing with low power drivers and logic ICs including microcontrollers.

2. Features and benefits

- 3Q technology for improved noise immunity
- Direct triggering from low power drivers and logic ICs
- High commutation capability with sensitive gate
- High immunity to false turn-on by dV/dt
- High voltage capability
- Planar passivated for voltage ruggedness and reliability
- Sensitive gate for easy logic level triggering
- Surface mountable package
- Triggering in three quadrants only

3. Applications

- General purpose motor control
- Small loads in washing machines
- Solenoid drivers

4. Quick reference data

Table 1. Quick reference data

| Symbol | Parameter | Conditions | Min | Typ | Max | Unit |
|-------------------------------|--------------------------------------|--|-----|-----|------|------|
| V_{DRM} | repetitive peak off-state voltage | | - | - | 800 | V |
| I_{TSM} | non-repetitive peak on-state current | full sine wave; $T_{j(init)} = 25\text{ °C}$; $t_p = 20\text{ ms}$; Fig. 4 ; Fig. 5 | - | - | 12.5 | A |
| $I_{T(RMS)}$ | RMS on-state current | full sine wave; $T_{sp} \leq 106\text{ °C}$; Fig. 1 ; Fig. 2 ; Fig. 3 | - | - | 1 | A |
| Static characteristics | | | | | | |
| I_{GT} | gate trigger current | $V_D = 12\text{ V}$; $I_T = 0.1\text{ A}$; T2+ G+; $T_j = 25\text{ °C}$; Fig. 9 | 1 | - | 10 | mA |



NXP Semiconductors

BTA201W-800E

3Q Hi-Com triac

| Symbol | Parameter | Conditions | Min | Typ | Max | Unit |
|--------|-----------|---|-----|-----|-----|------|
| | | $V_D = 12\text{ V}$; $I_T = 0.1\text{ A}$; T2+ G-; $T_j = 25\text{ °C}$; Fig. 9 | 1 | - | 10 | mA |
| | | $V_D = 12\text{ V}$; $I_T = 0.1\text{ A}$; T2- G-; $T_j = 25\text{ °C}$; Fig. 9 | 1 | - | 10 | mA |

5. Pinning information

Table 2. Pinning information

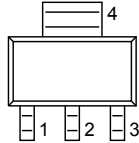
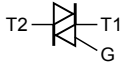
| Pin | Symbol | Description | Simplified outline | Graphic symbol |
|-----|--------|-----------------|--|---|
| 1 | T1 | main terminal 1 |  <p>SC-73 (SOT223)</p> |  <p>sym051</p> |
| 2 | T2 | main terminal 2 | | |
| 3 | G | gate | | |
| 4 | T2 | main terminal 2 | | |

6. Ordering information

Table 3. Ordering information

| Type number | Package | | |
|--------------|---------|--|---------|
| | Name | Description | Version |
| BTA201W-800E | SC-73 | plastic surface-mounted package with increased heatsink; 4 leads | SOT223 |

7. Limiting values

Table 4. Limiting values

In accordance with the Absolute Maximum Rating System (IEC 60134).

| Symbol | Parameter | Conditions | Min | Max | Unit |
|--------------|--------------------------------------|--|-----|------|-------------|
| V_{DRM} | repetitive peak off-state voltage | | - | 800 | V |
| $I_{T(RMS)}$ | RMS on-state current | full sine wave; $T_{sp} \leq 106\text{ °C}$; Fig. 1 ; Fig. 2 ; Fig. 3 | - | 1 | A |
| I_{TSM} | non-repetitive peak on-state current | full sine wave; $T_{j(init)} = 25\text{ °C}$; t_p 16.7 ms | - | 13.7 | A |
| | | full sine wave; $T_{j(init)} = 25\text{ °C}$; $t_p = 20\text{ ms}$; Fig. 4 ; Fig. 5 | - | 12.5 | A |
| I^2t | I^2t for fusing | $t_p = 10\text{ ms}$; SIN | - | 0.78 | A^2s |
| di_T/dt | rate of rise of on-state current | $I_T = 1.5\text{ A}$; $I_G = 0.2\text{ A}$; $di_G/dt = 0.2\text{ A}/\mu s$ | - | 100 | $A/\mu s$ |
| I_{GM} | peak gate current | | - | 1 | A |
| P_{GM} | peak gate power | | - | 2 | W |
| $P_{G(AV)}$ | average gate power | over any 20ms period | - | 0.1 | W |
| T_{stg} | storage temperature | | -40 | 150 | $^{\circ}C$ |
| T_j | junction temperature | | - | 125 | $^{\circ}C$ |

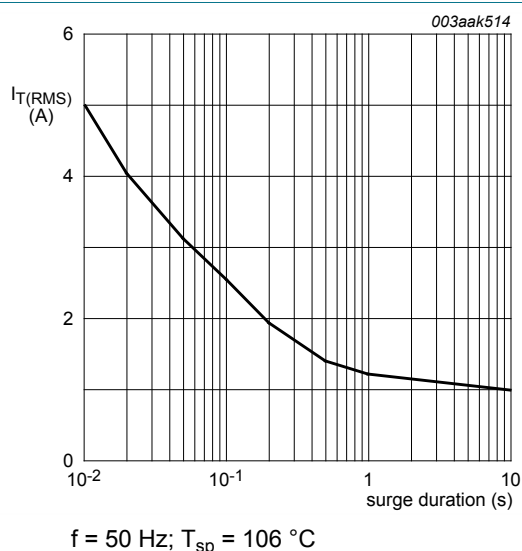

Fig. 1. RMS on-state current as a function of surge duration; maximum values

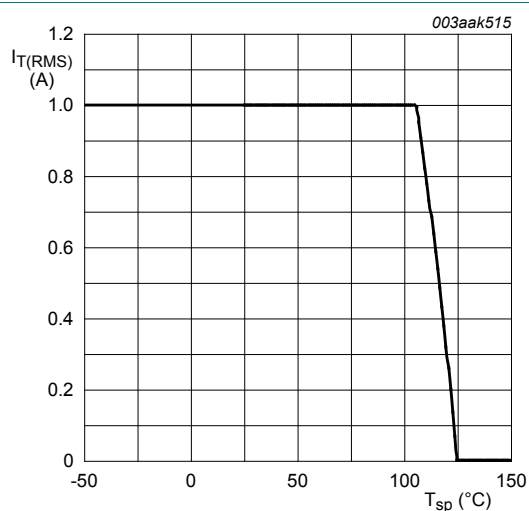

Fig. 2. RMS on-state current as a function of solder point temperature; maximum values

NXP Semiconductors

BTA201W-800E

3Q Hi-Com triac

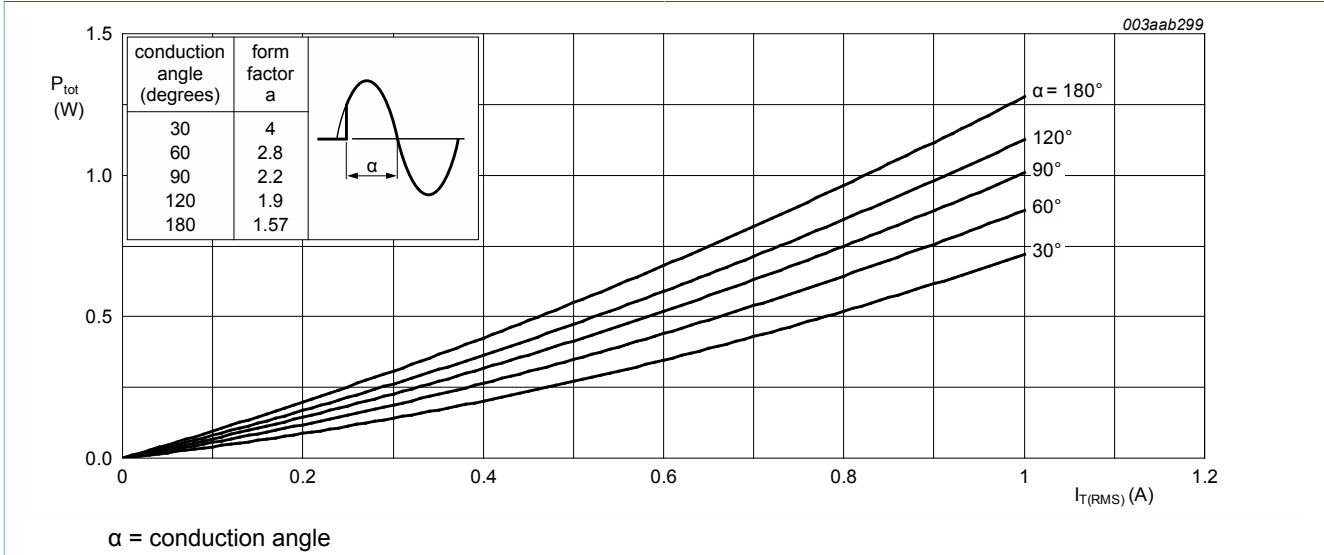

Fig. 3. Total power dissipation as a function of RMS on-state current; maximum values

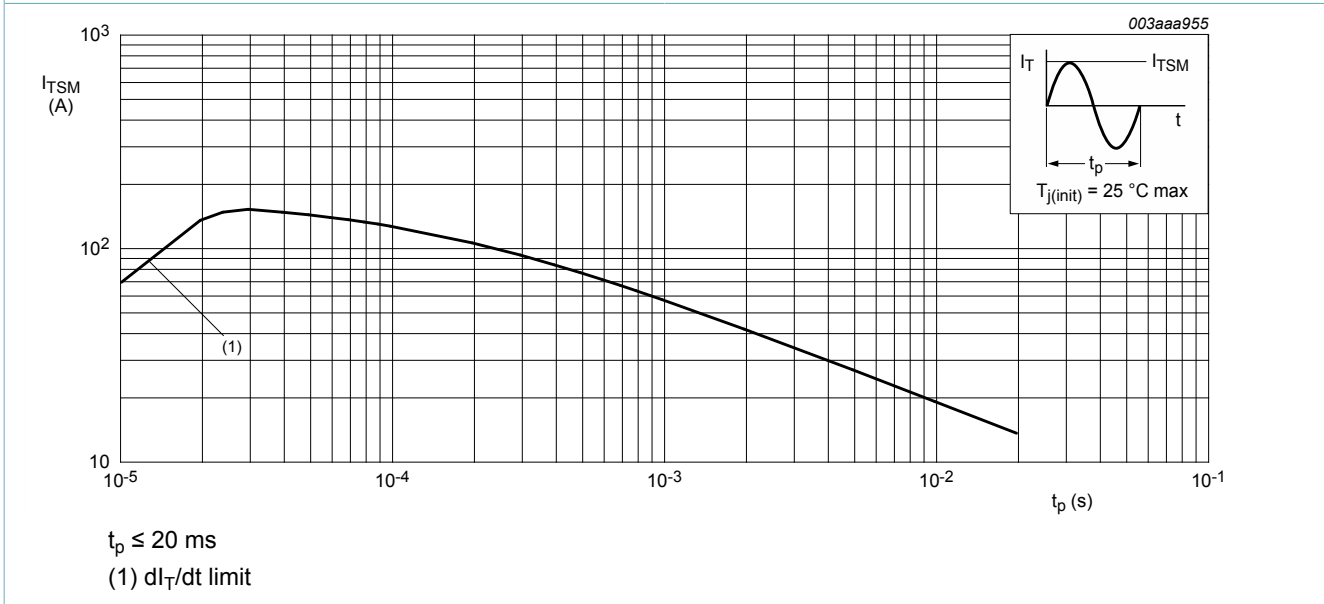
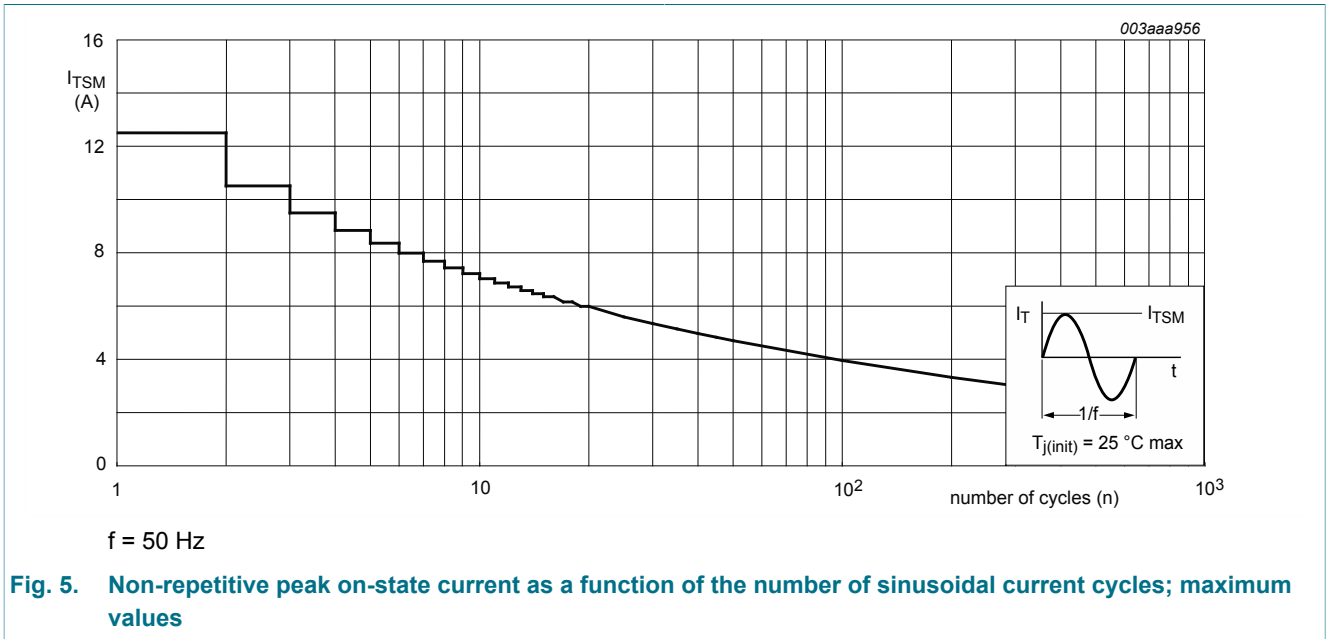

Fig. 4. Non-repetitive peak on-state current as a function of pulse width; maximum values

NXP Semiconductors

BTA201W-800E

3Q Hi-Com triac



8. Thermal characteristics

Table 5. Thermal characteristics

| Symbol | Parameter | Conditions | Min | Typ | Max | Unit |
|----------------|--|--|-----|-----|-----|------|
| $R_{th(j-sp)}$ | thermal resistance from junction to solder point | full and half cycle; Fig. 6 | - | - | 15 | K/W |
| $R_{th(j-a)}$ | thermal resistance from junction to ambient | printed circuit board mounted: minimum pad area; Fig. 7 | - | 70 | - | K/W |
| | | printed circuit board mounted: minimum footprint; Fig. 8 | - | 156 | - | K/W |

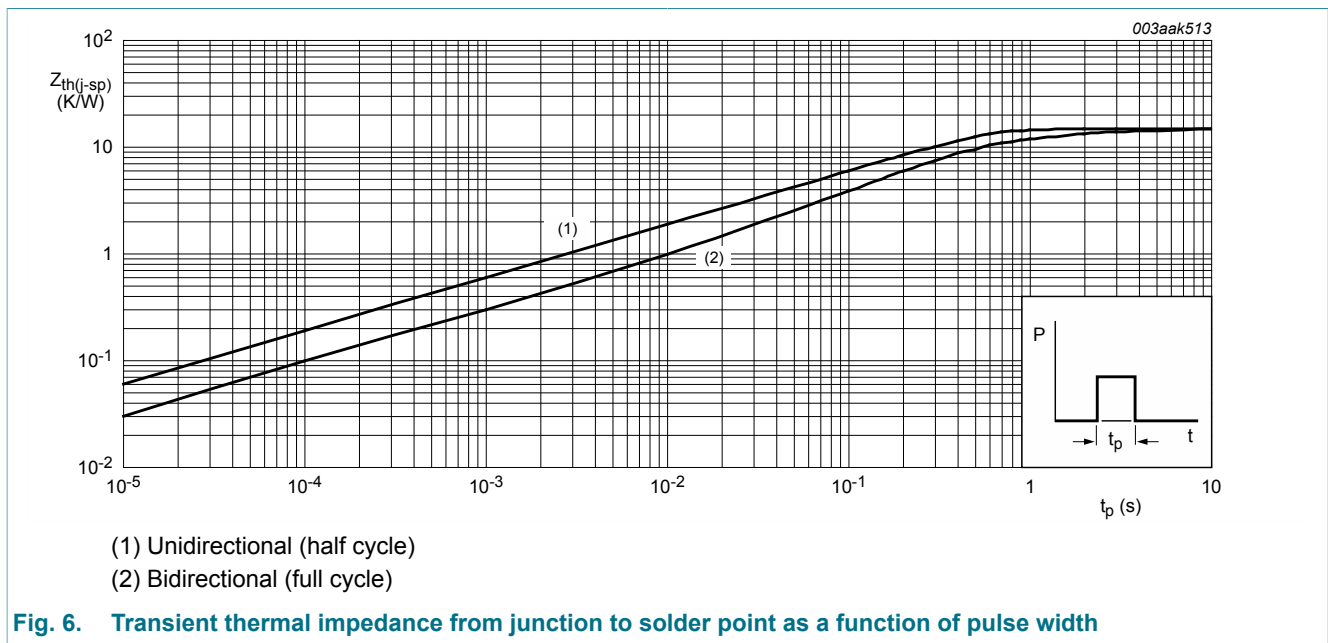

NXP Semiconductors

BTA201W-800E

3Q Hi-Com triac

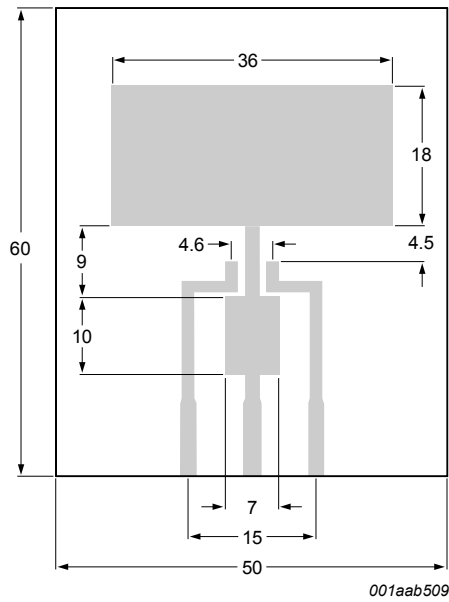

All dimensions are in mm
 Printed circuit board:
 FR4 epoxy glass (1.6 mm thick), copper laminate
 (35 um thick)

Fig. 7. Printed circuit board pad area: SOT223

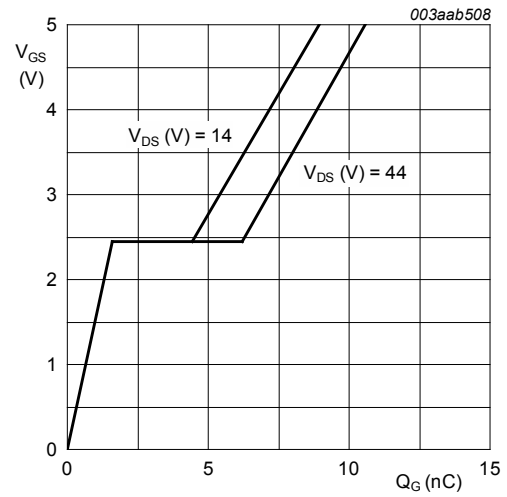

Fig. 8. Gate-source voltage as a function of gate charge; typical values

$$T_j = 25^\circ\text{C}; I_D = 10\text{A}$$

9. Characteristics

Table 6. Characteristics

| Symbol | Parameter | Conditions | Min | Typ | Max | Unit |
|--------------------------------|---------------------------------------|--|-----|-----|-----|------|
| Static characteristics | | | | | | |
| I _{GT} | gate trigger current | V _D = 12 V; I _T = 0.1 A; T2+ G+; T _j = 25 °C; Fig. 9 | 1 | - | 10 | mA |
| | | V _D = 12 V; I _T = 0.1 A; T2+ G-; T _j = 25 °C; Fig. 9 | 1 | - | 10 | mA |
| | | V _D = 12 V; I _T = 0.1 A; T2- G-; T _j = 25 °C; Fig. 9 | 1 | - | 10 | mA |
| I _L | latching current | V _D = 12 V; I _G = 0.1 A; T2+ G-; T _j = 25 °C; Fig. 10 | - | - | 12 | mA |
| | | V _D = 12 V; I _G = 0.1 A; T2+ G+; T _j = 25 °C; Fig. 10 | - | - | 12 | mA |
| | | V _D = 12 V; I _G = 0.1 A; T2- G-; T _j = 25 °C; Fig. 10 | - | - | 12 | mA |
| I _H | holding current | V _D = 12 V; T _j = 25 °C; Fig. 11 | - | - | 12 | mA |
| V _T | on-state voltage | I _T = 1.4 A; T _j = 25 °C; Fig. 12 | - | 1.3 | 1.5 | V |
| V _{GT} | gate trigger voltage | V _D = 12 V; I _T = 0.1 A; T _j = 25 °C; Fig. 13 | - | 0.7 | 1 | V |
| | | V _D = 400 V; I _T = 0.1 A; T _j = 125 °C; Fig. 13 | 0.2 | 0.3 | - | V |
| I _D | off-state current | V _D = 800 V; T _j = 125 °C | - | 0.1 | 0.5 | mA |
| Dynamic characteristics | | | | | | |
| dV _D /dt | rate of rise of off-state voltage | V _{DM} = 536 V; T _j = 125 °C; (V _{DM} = 67% of V _{DRM}); exponential waveform; gate open circuit; Fig. 14 | 600 | - | - | V/μs |
| dI _{com} /dt | rate of change of commutating current | V _D = 400 V; T _j = 125 °C; I _{T(RMS)} = 1 A; dV _{com} /dt = 20 V/s; (snubberless condition); gate open circuit | 2.5 | - | - | A/ms |
| | | V _D = 400 V; T _j = 125 °C; I _{T(RMS)} = 1 A; dV _{com} /dt = 10 V/s; gate open circuit | 3.5 | - | - | A/ms |

NXP Semiconductors

BTA201W-800E

3Q Hi-Com triac

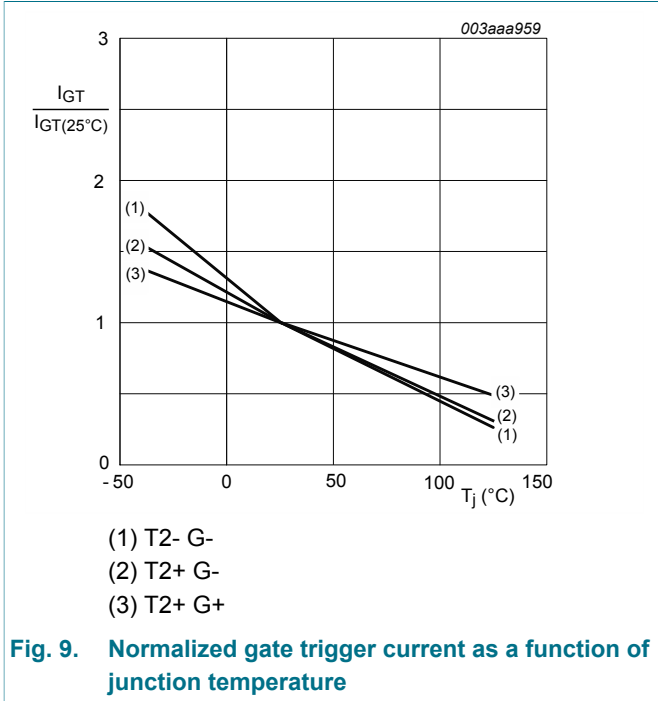

Fig. 9. Normalized gate trigger current as a function of junction temperature

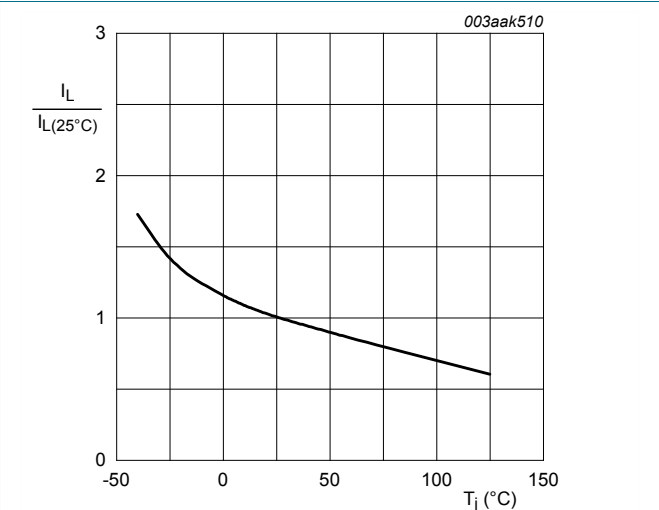

Fig. 10. Normalized latching current as a function of junction temperature

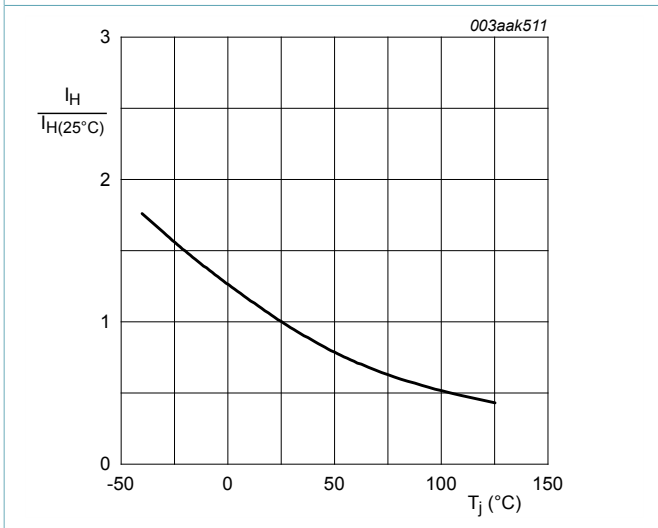
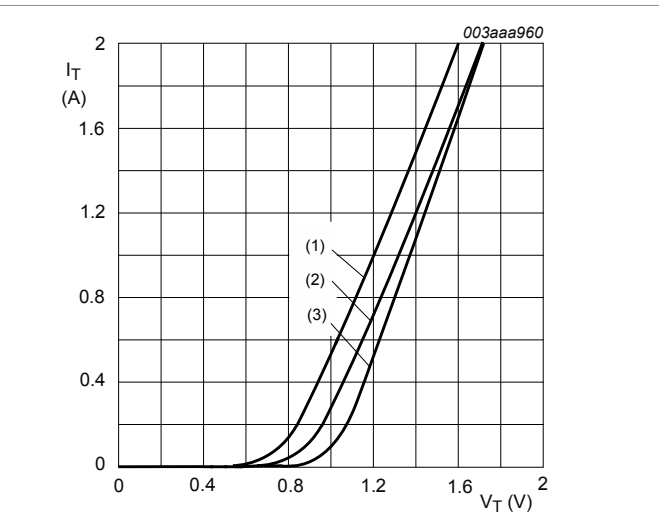

Fig. 11. Normalized holding current as a function of junction temperature



$V_o = 1.02\text{ V}$; $R_s = 0.358\ \Omega$
 (1) $T_j = 125^\circ\text{C}$; typical values
 (2) $T_j = 125^\circ\text{C}$; maximum values
 (3) $T_j = 25^\circ\text{C}$; maximum values

Fig. 12. On-state current as a function of on-state voltage

NXP Semiconductors

BTA201W-800E

3Q Hi-Com triac

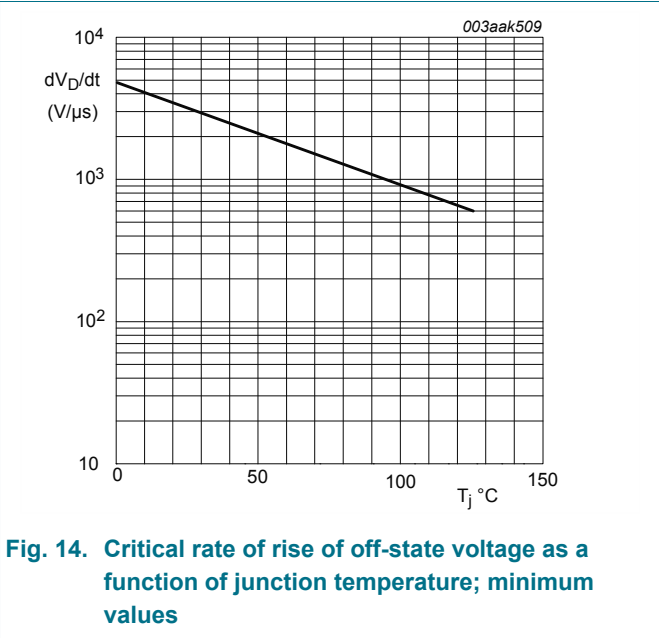
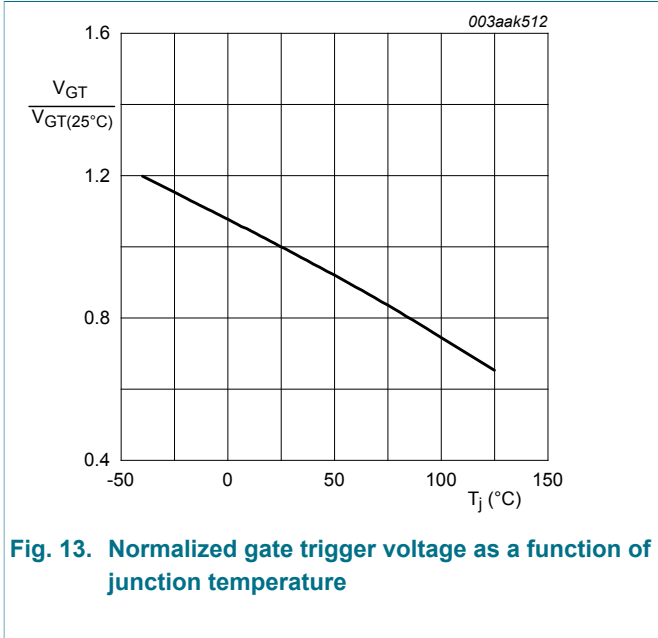

10. Package outline

Plastic surface-mounted package with increased heatsink; 4 leads

SOT223

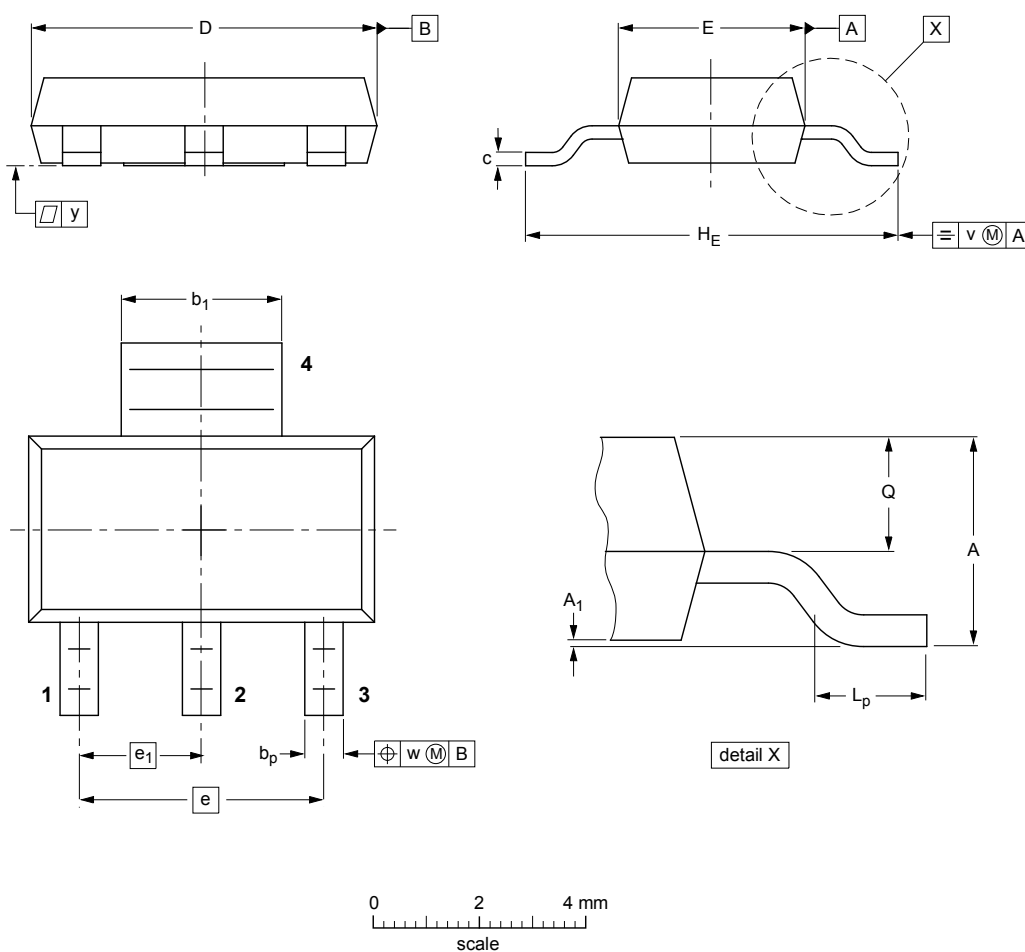

DIMENSIONS (mm are the original dimensions)

| UNIT | A | A ₁ | b _p | b ₁ | c | D | E | e | e ₁ | H _E | L _p | Q | v | w | y |
|------|------------|----------------|----------------|----------------|--------------|------------|------------|-----|----------------|----------------|----------------|--------------|-----|-----|-----|
| mm | 1.8 1.5 | 0.10 0.01 | 0.80 0.60 | 3.1 2.9 | 0.32 0.22 | 6.7 6.3 | 3.7 3.3 | 4.6 | 2.3 | 7.3 6.7 | 1.1 0.7 | 0.95 0.85 | 0.2 | 0.1 | 0.1 |

| OUTLINE VERSION | REFERENCES | | | | EUROPEAN PROJECTION | ISSUE DATE |
|-----------------|------------|-------|-------|--|---------------------|----------------------|
| | IEC | JEDEC | JEITA | | | |
| SOT223 | | | SC-73 | | | 04-11-10 06-03-16 |

Fig. 15. Package outline SC-73 (SOT223)

11. Soldering

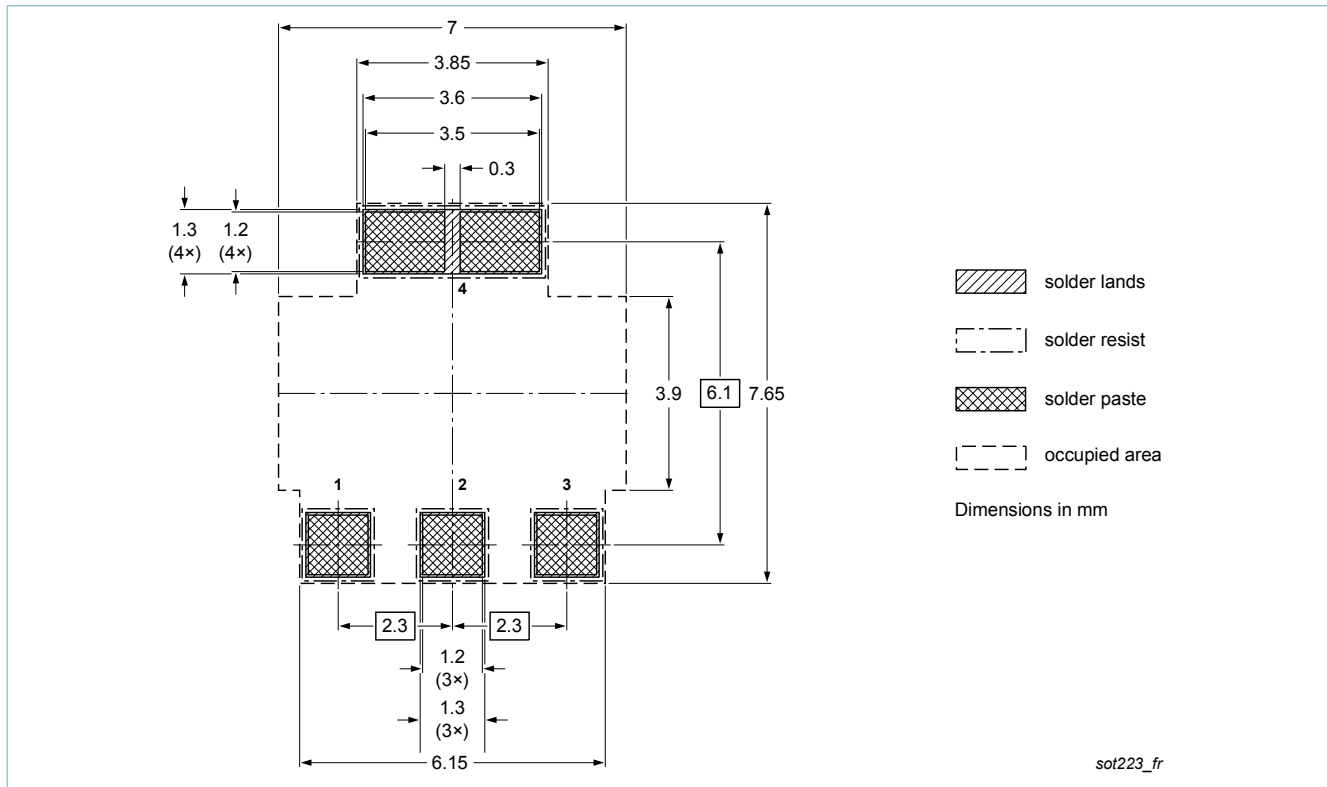

Fig. 16. Reflow soldering footprint for SC-73 (SOT223)

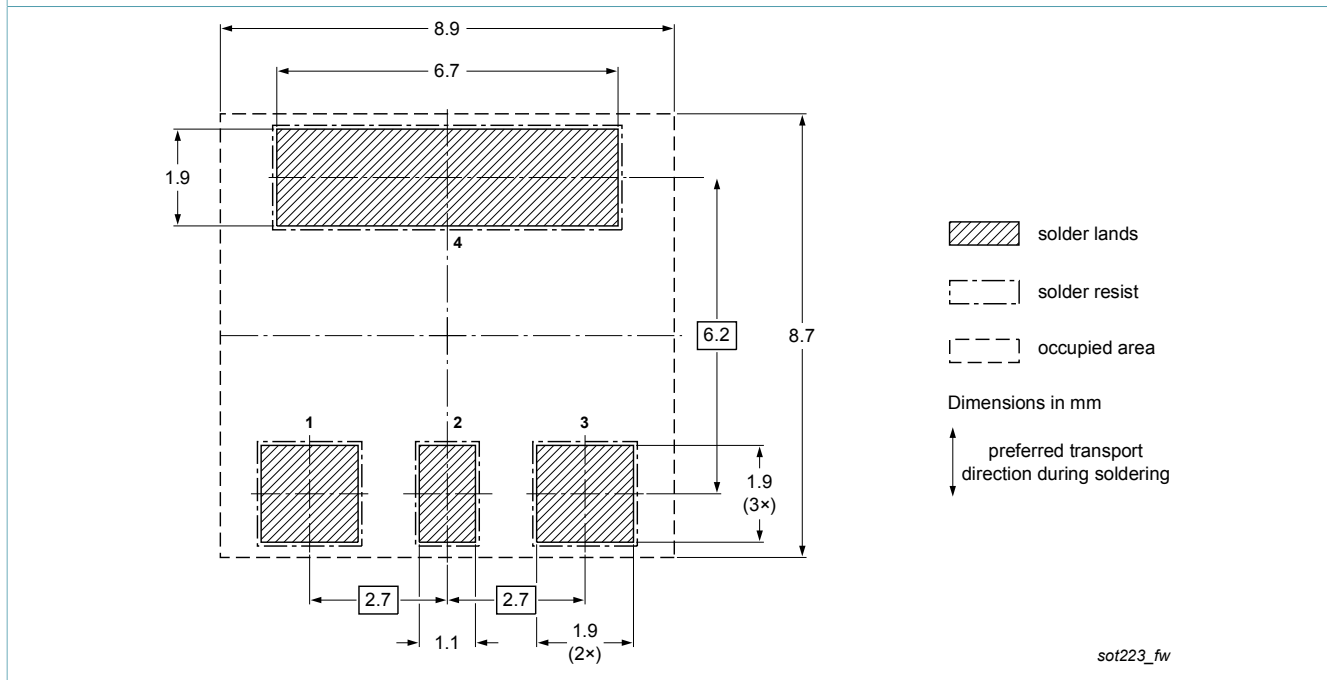

Fig. 17. Wave soldering footprint for SC-73 (SOT223)

12. Legal information

12.1 Data sheet status

| Document status [1][2] | Product status [3] | Definition |
|--------------------------------|--------------------|---|
| Objective [short] data sheet | Development | This document contains data from the objective specification for product development. |
| Preliminary [short] data sheet | Qualification | This document contains data from the preliminary specification. |
| Product [short] data sheet | Production | This document contains the product specification. |

- [1] Please consult the most recently issued document before initiating or completing a design.
- [2] The term 'short data sheet' is explained in section "Definitions".
- [3] The product status of device(s) described in this document may have changed since this document was published and may differ in case of multiple devices. The latest product status information is available on the Internet at URL <http://www.nxp.com>.

12.2 Definitions

Preview — The document is a preview version only. The document is still subject to formal approval, which may result in modifications or additions. NXP Semiconductors does not give any representations or warranties as to the accuracy or completeness of information included herein and shall have no liability for the consequences of use of such information.

Draft — The document is a draft version only. The content is still under internal review and subject to formal approval, which may result in modifications or additions. NXP Semiconductors does not give any representations or warranties as to the accuracy or completeness of information included herein and shall have no liability for the consequences of use of such information.

Short data sheet — A short data sheet is an extract from a full data sheet with the same product type number(s) and title. A short data sheet is intended for quick reference only and should not be relied upon to contain detailed and full information. For detailed and full information see the relevant full data sheet, which is available on request via the local NXP Semiconductors sales office. In case of any inconsistency or conflict with the short data sheet, the full data sheet shall prevail.

Product specification — The information and data provided in a Product data sheet shall define the specification of the product as agreed between NXP Semiconductors and its customer, unless NXP Semiconductors and customer have explicitly agreed otherwise in writing. In no event however, shall an agreement be valid in which the NXP Semiconductors product is deemed to offer functions and qualities beyond those described in the Product data sheet.

12.3 Disclaimers

Limited warranty and liability — Information in this document is believed to be accurate and reliable. However, NXP Semiconductors does not give any representations or warranties, expressed or implied, as to the accuracy or completeness of such information and shall have no liability for the consequences of use of such information. NXP Semiconductors takes no responsibility for the content in this document if provided by an information source outside of NXP Semiconductors.

In no event shall NXP Semiconductors be liable for any indirect, incidental, punitive, special or consequential damages (including - without limitation - lost profits, lost savings, business interruption, costs related to the removal or replacement of any products or rework charges) whether or not such damages are based on tort (including negligence), warranty, breach of contract or any other legal theory.

Notwithstanding any damages that customer might incur for any reason whatsoever, NXP Semiconductors' aggregate and cumulative liability towards customer for the products described herein shall be limited in accordance with the *Terms and conditions of commercial sale* of NXP Semiconductors.

Right to make changes — NXP Semiconductors reserves the right to make changes to information published in this document, including without limitation specifications and product descriptions, at any time and without notice. This document supersedes and replaces all information supplied prior to the publication hereof.

Suitability for use — NXP Semiconductors products are not designed, authorized or warranted to be suitable for use in life support, life-critical or safety-critical systems or equipment, nor in applications where failure or malfunction of an NXP Semiconductors product can reasonably be expected to result in personal injury, death or severe property or environmental damage. NXP Semiconductors and its suppliers accept no liability for inclusion and/or use of NXP Semiconductors products in such equipment or applications and therefore such inclusion and/or use is at the customer's own risk.

Quick reference data — The Quick reference data is an extract of the product data given in the Limiting values and Characteristics sections of this document, and as such is not complete, exhaustive or legally binding.

Applications — Applications that are described herein for any of these products are for illustrative purposes only. NXP Semiconductors makes no representation or warranty that such applications will be suitable for the specified use without further testing or modification.

Customers are responsible for the design and operation of their applications and products using NXP Semiconductors products, and NXP Semiconductors accepts no liability for any assistance with applications or customer product design. It is customer's sole responsibility to determine whether the NXP Semiconductors product is suitable and fit for the customer's applications and products planned, as well as for the planned application and use of customer's third party customer(s). Customers should provide appropriate design and operating safeguards to minimize the risks associated with their applications and products.

NXP Semiconductors does not accept any liability related to any default, damage, costs or problem which is based on any weakness or default in the customer's applications or products, or the application or use by customer's third party customer(s). Customer is responsible for doing all necessary testing for the customer's applications and products using NXP Semiconductors products in order to avoid a default of the applications and the products or of the application or use by customer's third party customer(s). NXP does not accept any liability in this respect.

Limiting values — Stress above one or more limiting values (as defined in the Absolute Maximum Ratings System of IEC 60134) will cause permanent damage to the device. Limiting values are stress ratings only and (proper) operation of the device at these or any other conditions above those given in the Recommended operating conditions section (if present) or the Characteristics sections of this document is not warranted. Constant or repeated exposure to limiting values will permanently and irreversibly affect the quality and reliability of the device.

Terms and conditions of commercial sale — NXP Semiconductors products are sold subject to the general terms and conditions of commercial sale, as published at <http://www.nxp.com/profile/terms>, unless otherwise agreed in a valid written individual agreement. In case an individual agreement is concluded only the terms and conditions of the respective agreement shall apply. NXP Semiconductors hereby expressly objects to applying the customer's general terms and conditions with regard to the purchase of NXP Semiconductors products by customer.

No offer to sell or license — Nothing in this document may be interpreted or construed as an offer to sell products that is open for acceptance or the

grant, conveyance or implication of any license under any copyrights, patents or other industrial or intellectual property rights.

Export control — This document as well as the item(s) described herein may be subject to export control regulations. Export might require a prior authorization from competent authorities.

Non-automotive qualified products — Unless this data sheet expressly states that this specific NXP Semiconductors product is automotive qualified, the product is not suitable for automotive use. It is neither qualified nor tested in accordance with automotive testing or application requirements. NXP Semiconductors accepts no liability for inclusion and/or use of non-automotive qualified products in automotive equipment or applications.

In the event that customer uses the product for design-in and use in automotive applications to automotive specifications and standards, customer (a) shall use the product without NXP Semiconductors' warranty of the product for such automotive applications, use and specifications, and (b) whenever customer uses the product for automotive applications beyond NXP Semiconductors' specifications such use shall be solely at customer's own risk, and (c) customer fully indemnifies NXP Semiconductors for any liability, damages or failed product claims resulting from customer design and use of the product for automotive applications beyond NXP Semiconductors' standard warranty and NXP Semiconductors' product specifications.

Translations — A non-English (translated) version of a document is for reference only. The English version shall prevail in case of any discrepancy between the translated and English versions.

12.4 Trademarks

Notice: All referenced brands, product names, service names and trademarks are the property of their respective owners.

Adelante, Bitport, Bitsound, CoolFlux, CoReUse, DESFire, EZ-HV, FabKey, GreenChip, HiPerSmart, HITAG, I²C-bus logo, ICODE, I-CODE, ITEC, Labelution, MIFARE, MIFARE Plus, MIFARE Ultralight, MoReUse, QLPAK, Silicon Tuner, SiliconMAX, SmartXA, STARplug, TOPFET, TrenchMOS, TriMedia and UCODE — are trademarks of NXP Semiconductors N.V.

HD Radio and **HD Radio** logo — are trademarks of iBiquity Digital Corporation.

13. Contents

| | | |
|------|-------------------------------|----|
| 1 | General description | 1 |
| 2 | Features and benefits | 1 |
| 3 | Applications | 1 |
| 4 | Quick reference data | 1 |
| 5 | Pinning information | 2 |
| 6 | Ordering information | 2 |
| 7 | Limiting values | 3 |
| 8 | Thermal characteristics | 6 |
| 9 | Characteristics | 8 |
| 10 | Package outline | 11 |
| 11 | Soldering | 12 |
| 12 | Legal information | 13 |
| 12.1 | Data sheet status | 13 |
| 12.2 | Definitions | 13 |
| 12.3 | Disclaimers | 13 |
| 12.4 | Trademarks | 14 |

© NXP Semiconductors N.V. 2014. All rights reserved

For more information, please visit: <http://www.nxp.com>

For sales office addresses, please send an email to: salesaddresses@nxp.com

Date of release: 13 August 2014