

Excellent Integrated System Limited

Stocking Distributor

Click to view price, real time Inventory, Delivery & Lifecycle Information:

[RFMD](#)
[RF2103PTR7](#)

For any questions, you can email us directly:

sales@integrated-circuit.com



rfmd.com

RF2103P

MEDIUM POWER LINEAR AMPLIFIER

RoHS Compliant & Pb-Free Product
 Package Style: SOIC-14

Features

- 450MHz to 1000MHz Operation
- Up to 750mW CW Output Power
- 31dB Small Signal Gain
- Single 2.7V to 7.5V Supply
- 47% Efficiency
- Digitally Controlled Power Down Mode

Applications

- Digital Communication Systems
- Spread-Spectrum Communication Systems
- Driver for Higher Power Linear Applications
- Portable Battery-Powered Equipment
- Commercial and Consumer Systems
- Base Station Equipment

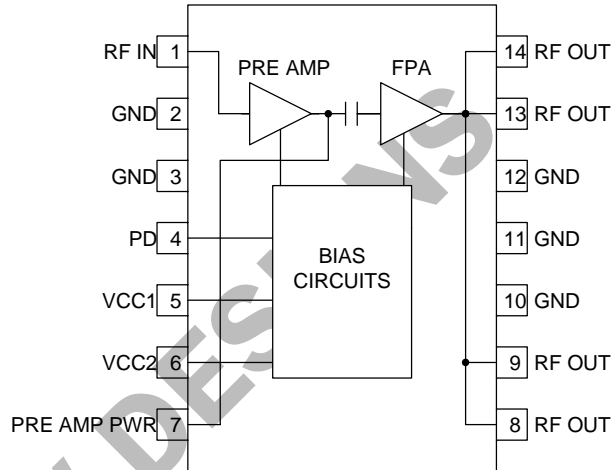

Functional Block Diagram

Product Description

The RF2103P is a medium power linear amplifier IC. The device is manufactured on an advanced Gallium Arsenide Heterojunction Bipolar Transistor (HBT) process, and has been designed for use as the final linear RF amplifier in UHF radio transmitters operating between 450MHz and 1000MHz. It may also be used as a driver amplifier in higher power applications. The device is self-contained with the exception of the output matching network, power supply feed line, and bypass capacitors, and it produces an output power level of 750mW (CW). The device can be used in 3 cell battery applications. The maximum CW output at 3.6V is 175mW. The unit has a total gain of 31dB, depending upon the output matching network.

Ordering Information

RF2103P	Medium Power Linear Amplifier
RF2103PPCBA-41X	Fully Assembled Evaluation Board

Optimum Technology Matching® Applied

- | | | | |
|--|--------------------------------------|-------------------------------------|-----------------------------------|
| <input checked="" type="checkbox"/> GaAs HBT | <input type="checkbox"/> SiGe BiCMOS | <input type="checkbox"/> GaAs pHEMT | <input type="checkbox"/> GaN HEMT |
| <input type="checkbox"/> GaAs MESFET | <input type="checkbox"/> Si BiCMOS | <input type="checkbox"/> Si CMOS | |
| <input type="checkbox"/> InGaP HBT | <input type="checkbox"/> SiGe HBT | <input type="checkbox"/> Si BJT | |

RF MICRO DEVICES®, RFMD®, Optimum Technology Matching®, Enabling Wireless Connectivity™, PowerStar®, POLARIS™ TOTAL RADIO™ and UltimateBlue™ are trademarks of RFMD, LLC. BLUETOOTH is a trademark owned by Bluetooth SIG, Inc., U.S.A. and licensed for use by RFMD. All other trade names, trademarks and registered trademarks are the property of their respective owners. ©2006, RF Micro Devices, Inc.

RF2103P



rfmd.com

Absolute Maximum Ratings

Parameter	Rating	Unit
Supply Voltage	-0.5 to +7.5	V _{DC}
Power Down Voltage (V _{PD})	-0.5 to +5	V
DC Supply Current	350	mA
Input RF Power	+12	dBm
Output Load VSWR	10:1	
Operating Case Temperature	-40 to +100	°C
Operating Ambient Temperature	-40 to +85	°C
Storage Temperature	-40 to +150	°C



Caution! ESD sensitive device.

Exceeding any one or a combination of the Absolute Maximum Rating conditions may cause permanent damage to the device. Extended application of Absolute Maximum Rating conditions to the device may reduce device reliability. Specified typical performance or functional operation of the device under Absolute Maximum Rating conditions is not implied.

RoHS status based on EUDirective2002/95/EC (at time of this document revision).

The information in this publication is believed to be accurate and reliable. However, no responsibility is assumed by RF Micro Devices, Inc. ("RFMD") for its use, nor for any infringement of patents, or other rights of third parties, resulting from its use. No license is granted by implication or otherwise under any patent or patent rights of RFMD. RFMD reserves the right to change component circuitry, recommended application circuitry and specifications at any time without prior notice.

Parameter	Specification			Unit	Condition
	Min.	Typ.	Max.		
Overall					T = 25 °C, V _{CC} = 5.8V, V _{PD} = 5.0V, Z _{LOAD} = 18Ω, P _{IN} = 0dBm, Freq = 915MHz
Frequency Range		450 to 1000		MHz	
Maximum Output Power		+28.8		dBm	V _{CC} = 7.5V
Maximum Output Power		+26.5		dBm	V _{CC} = 5.8V
Second Harmonic		-24		dBc	Without external second harmonic trap
Third Harmonic		-30		dBc	
Output Noise Power		<-125		dBm/Hz	
Input Impedance		50		Ω	With external matching network; see application schematic
Input VSWR		<2:1			With external matching network; see application schematic
Output Impedance		18+j0		Ω	Load Impedance for Optimal Match
Nominal 5.8V Configuration					V _{CC} = 5.8V, V _{PD} = 4.0V, Z _{LOAD} = 18Ω, P _{IN} = 0dBm, Freq = 830MHz
Linear Power Gain		31		dB	
Saturated CW Output Power	24	+26.5		dBm	
IM ₃		-40	-25	dBc	P _{OUT} = +18.5dBm/tone
IM ₅		-45	-30	dBc	P _{OUT} = +18.5dBm/tone
Collector Current, I _{CC}		175	250	mA	Total of pins 7 and 8
V _{PD} Current		<3.5		mA	Into pin 4
CW Total Efficiency		47		%	
Two Tone Total Efficiency		26		%	P _{OUT} = +18.5dBm/tone
Power Supply					
Power Supply Voltage		2.7 to 7.5		V	
Power Supply Idle Current		45	80	mA	
Total "OFF" Current Drain		1	10	μA	V _{PD} < 0.1V _{DC}
Turn-on Time		<100		ns	V _{PD} = 0 to V _{PD} = +4V _{DC}



rfmd.com

RF2103P

Pin	Function	Description	Interface Schematic
1	RF IN	RF input pin. There is an internal blocking capacitor between this pin and the preamp input, but not between the pin and an internal 2kΩ resistor to ground.	
2	GND	Ground connection. For best performance, keep traces physically short and connect immediately to ground plane.	
3	GND	Same as pin 2.	
4	PD	Power down control voltage. When this pin is at 0V, the device will be in power down mode, dissipating minimum DC power. When this pin is at V _{CC} (3V to 6.5V), the device will be in full power mode delivering maximum available gain and output power capability. This pin may also be used to perform some degree of gain control or power control when set to voltages between 0V and V _{CC} . It is not optimized for this function so the transfer function is not linear over a wide range as with other devices specifically designed for analog gain control; however, it may be usable for coarse adjustment or in some closed loop AGC systems. This pin should not, in any circumstance, be higher in voltage than V _{CC} . This pin should also have an external bypassing capacitor.	
5	VCC1	Positive supply for the active bias circuits. This pin can be externally combined with pin 6 (VCC2) and the pair bypassed with a single capacitor, placed as close as possible to the package. Additional bypassing of 1μF is also recommended, but proximity to the package is not as critical. In most applications, pins 5, 6, and 7 can share a single 1μF bypass capacitor.	
6	VCC2	Same as pin 5.	
7	PREAMP PWR	Positive supply for the pre-amplifier. This is an unmatched transistor collector output. This pin should see an inductive path to AC ground (V _{CC} with bypass capacitor). This inductance can be achieved with a short, thin microstrip line or with a low value chip inductor (approximately 1.8nH). At lower frequencies, the inductance value should be larger (longer microstrip line) and V _{CC} should be bypassed with a larger bypass capacitor. This inductance forms a matching network with the internal series capacitor between the two amplifier stages, setting the amplifier's frequency of maximum gain. An additional 1μF bypass capacitor in parallel with the 100pF bypass capacitor is also recommended, but placement of this component is not as critical. In most applications, pins 5, 6, and 7 can share a single 1μF bypass capacitor.	
8	RF OUT	Same as pin 14.	
9	RF OUT	Same as pin 14.	
10	GND	Same as pin 2.	
11	GND	Same as pin 2.	
12	GND	Same as pin 2.	
13	RF OUT	Same as pin 14.	

RF2103P



rfmd.com

Pin	Function	Description	Interface Schematic
14	RF OUT	<p>Amplifier RF output. This is an unmatched collector output of the final amplifier transistor. It is internally connected to pins 8, 9, 13 and 14 to provide low series inductance and flexibility in output matching. Bias for the final power amplifier output transistor must also be provided through two of these four pins. Typically, pins 8 and 9 are connected to a network that provides the DC bias and also creates a second harmonic trap. For 915MHz operation, this harmonic trap network is simply a single 2pF capacitor from both pins to ground. This capacitor series resonates with internal bond wires at two times the operating frequency, effectively shorting out the second harmonic. Shorting out this harmonic serves to increase the amplifier's maximum output power and efficiency, as well as to lower the level of the second harmonic output. Typically, pins 13 and 14 are externally connected very close to the package and used as the RF output with a matching network that presents the optimum load impedance to the PA for maximum power and efficiency, as well as providing DC blocking at the output. Shunt protection diodes are included to clip peak voltage excursions above approximately 15V to prevent voltage breakdown in worst case conditions.</p>	

Package Drawing

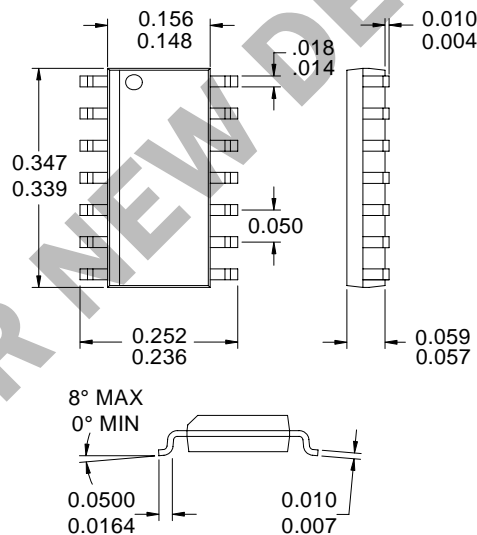

Application Schematic

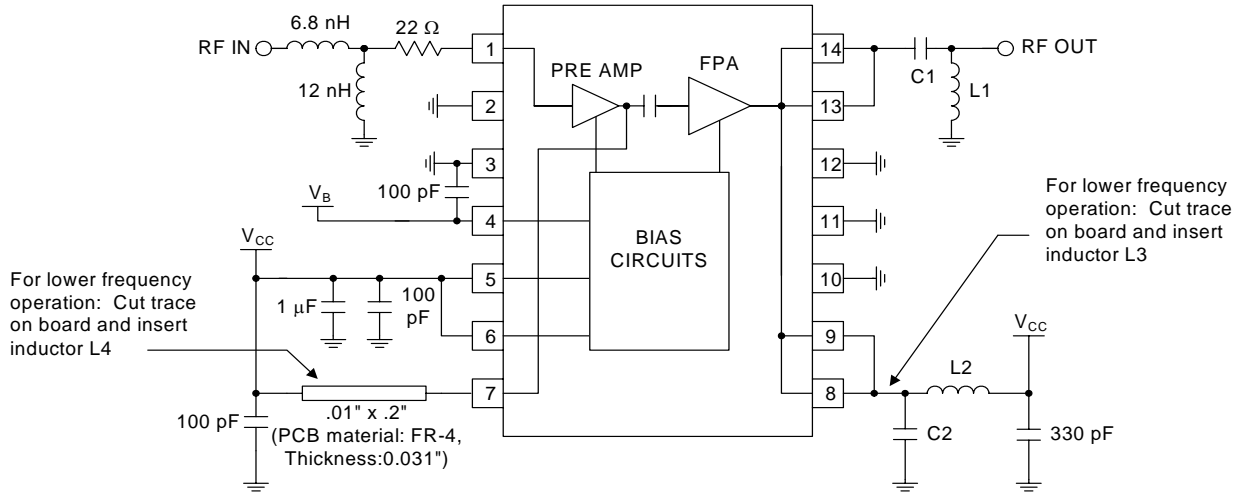

FREQUENCY (MHz)	L1 (nH)	L2 (nH)	L3 (nH)	L4 (nH)	C1 (pF)	C2 (pF)
275	20	15	10	20	20	10
480	12	6.8	4.7	18	12	6.8
915	6.8	3.3	—	—	4	2

NOT FOR NEW

RF2103P



rfmd.com

Evaluation Board Schematic 915MHz Operation

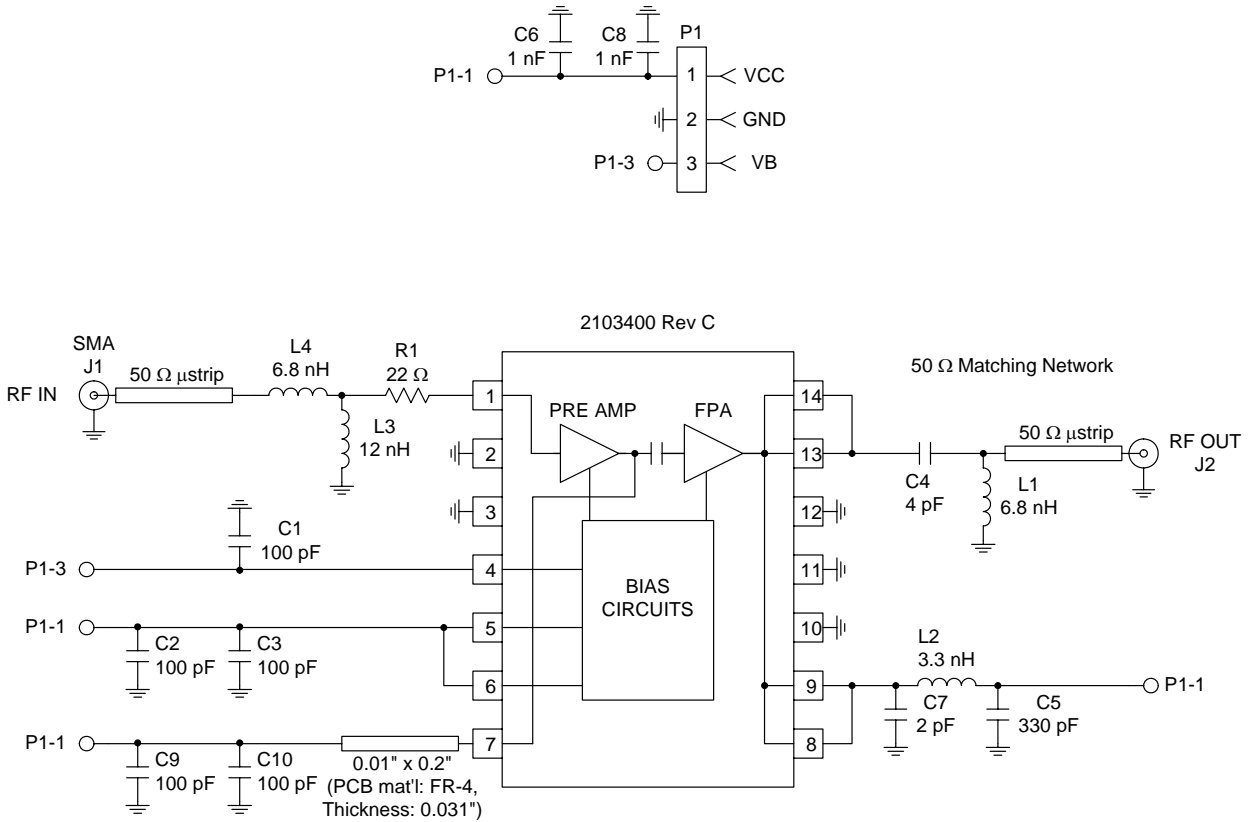

NOT FOR

Evaluation Board Layout
1.4" x 1.4"

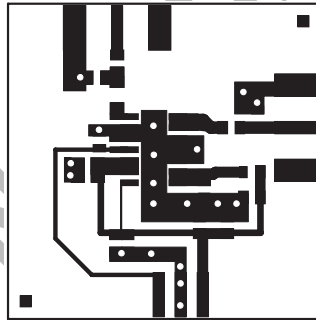
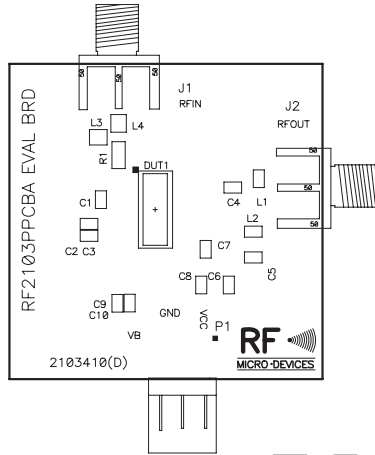

NOT FOR M...IGNS

RF2103P



rfmd.com

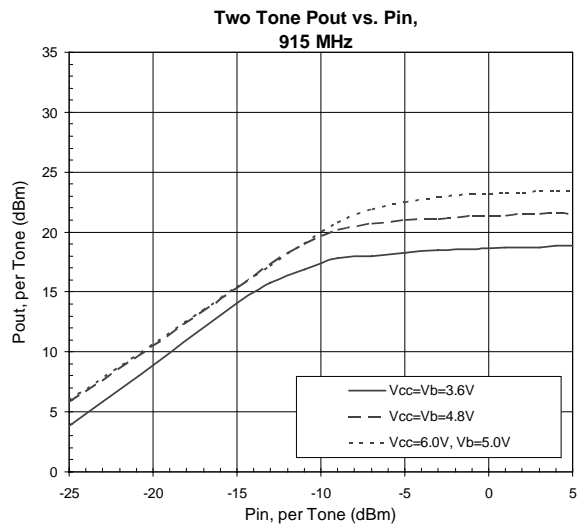
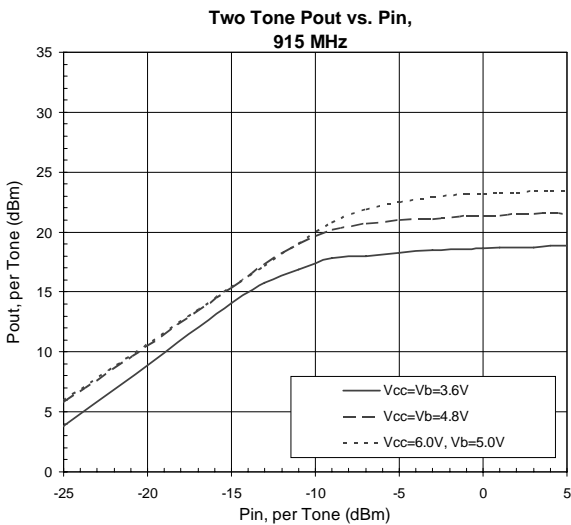
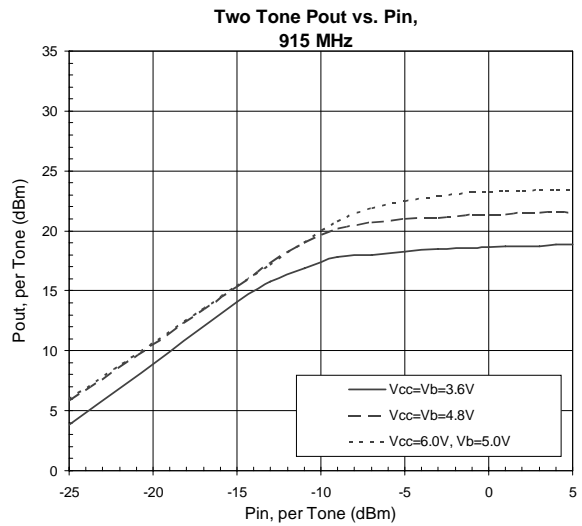
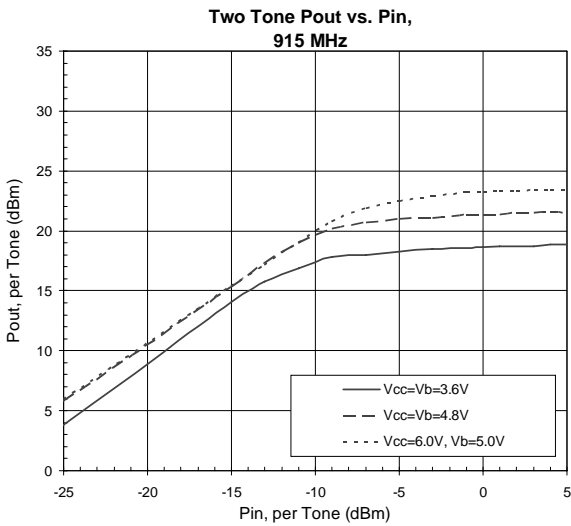
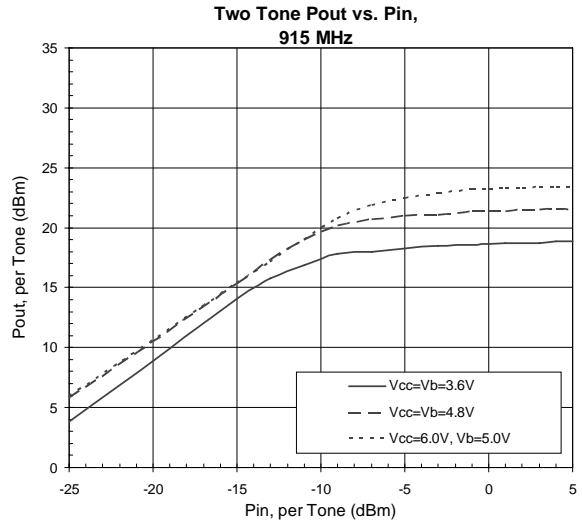
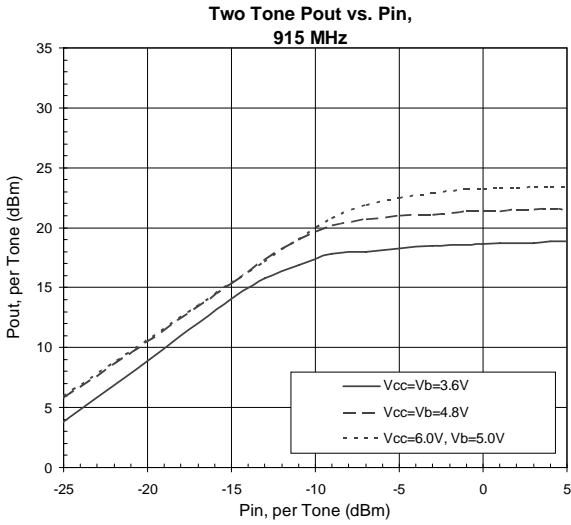

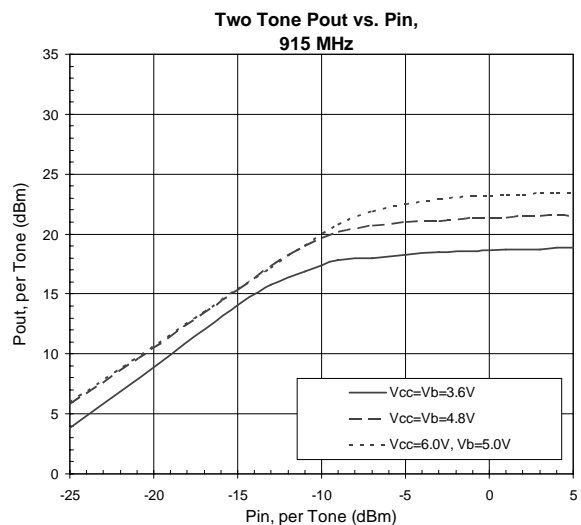
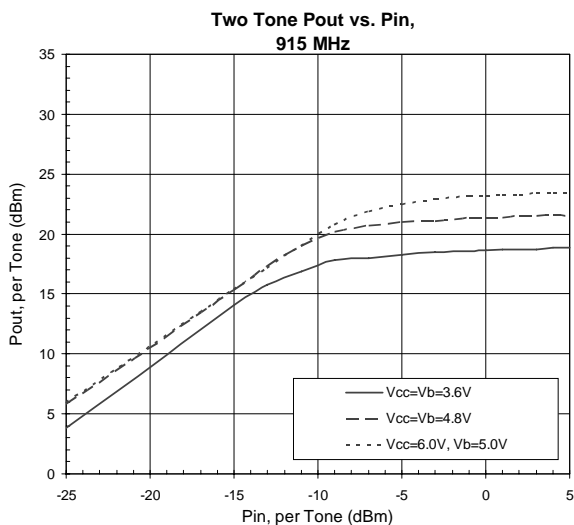
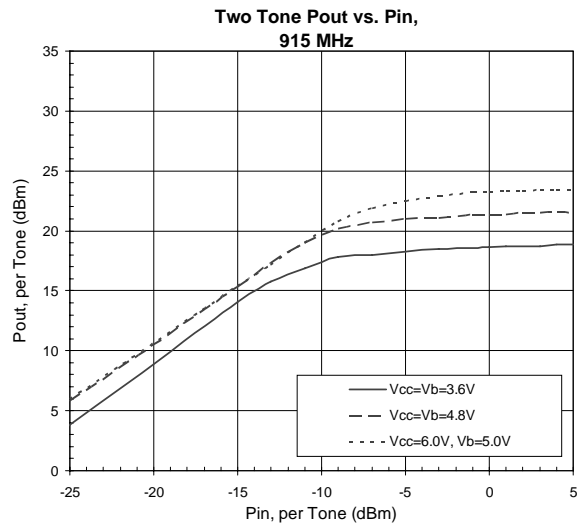
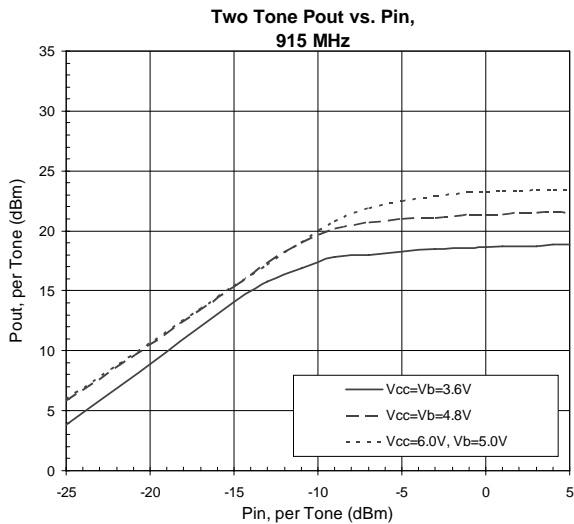
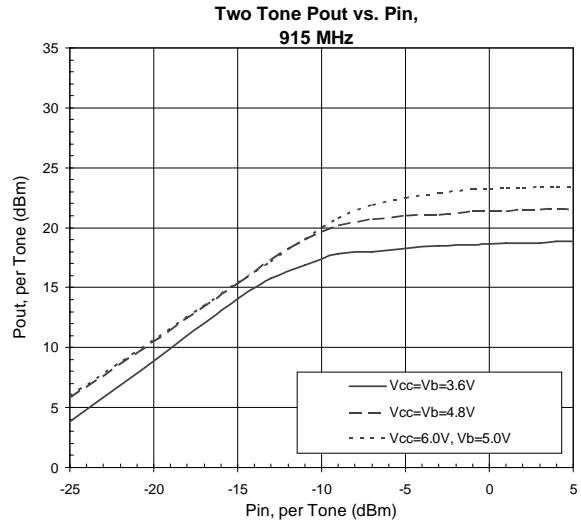
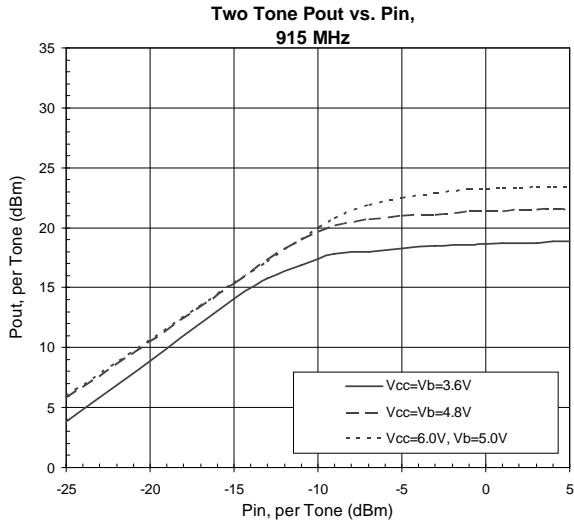

RF2103P



rfmd.com

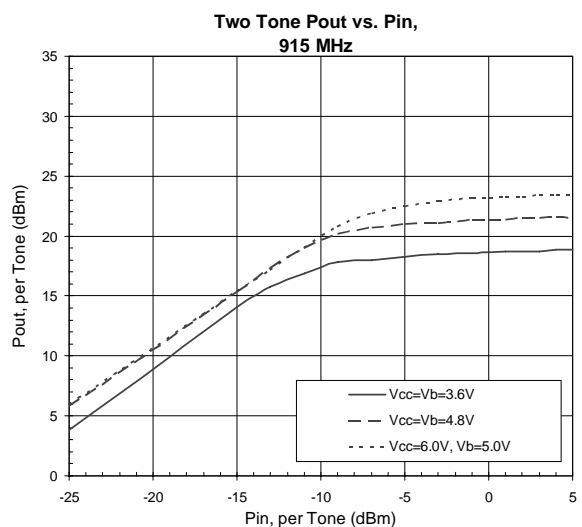
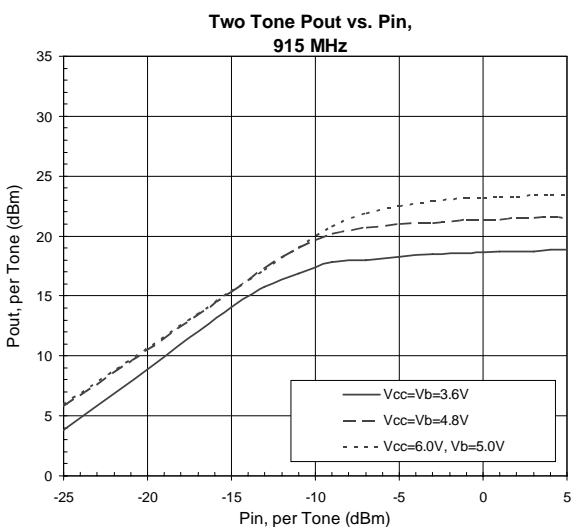
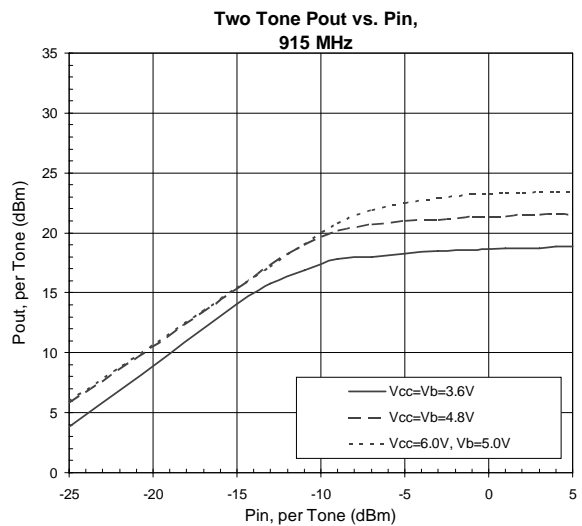
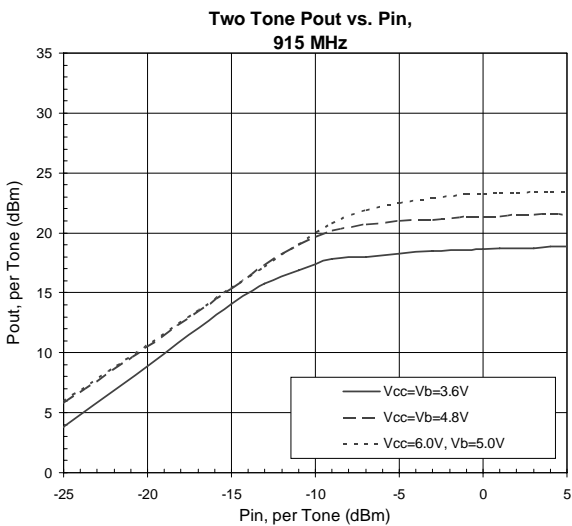
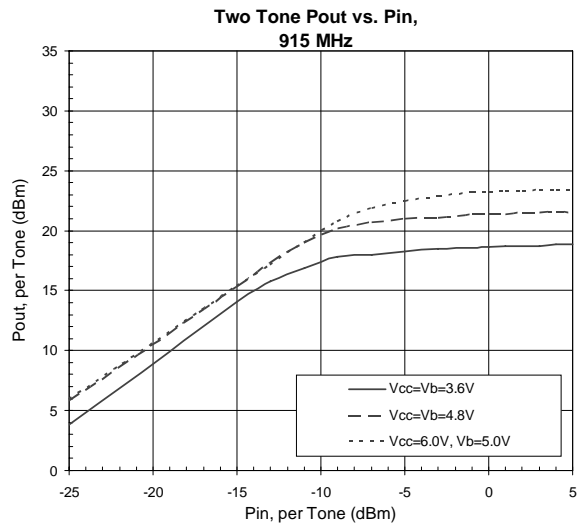
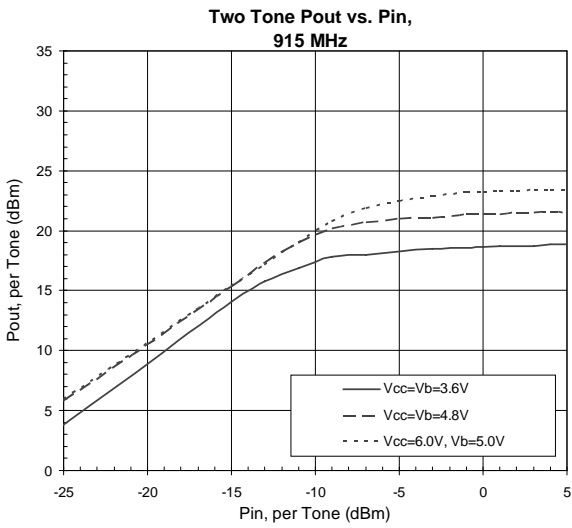

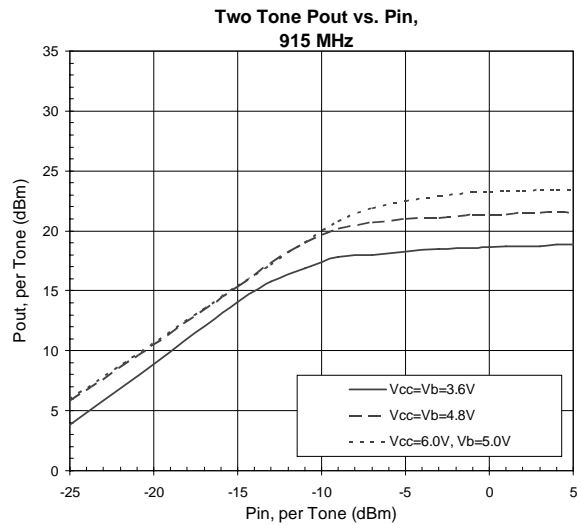
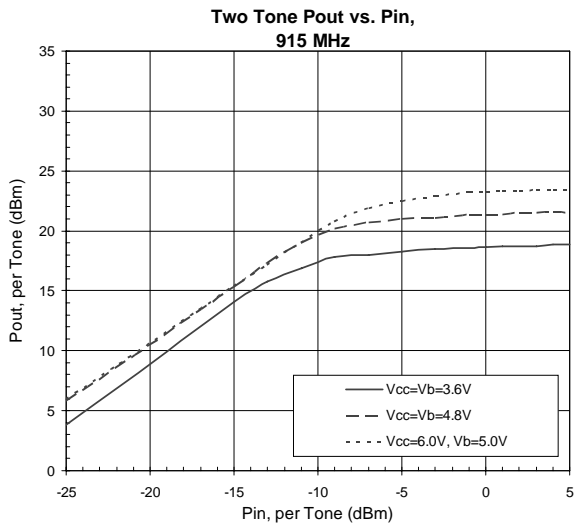
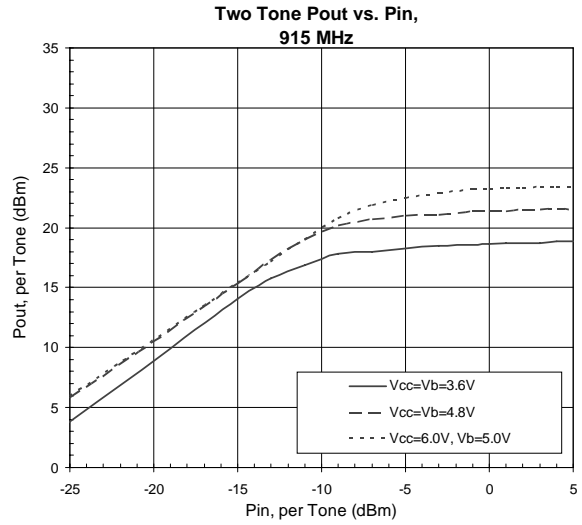
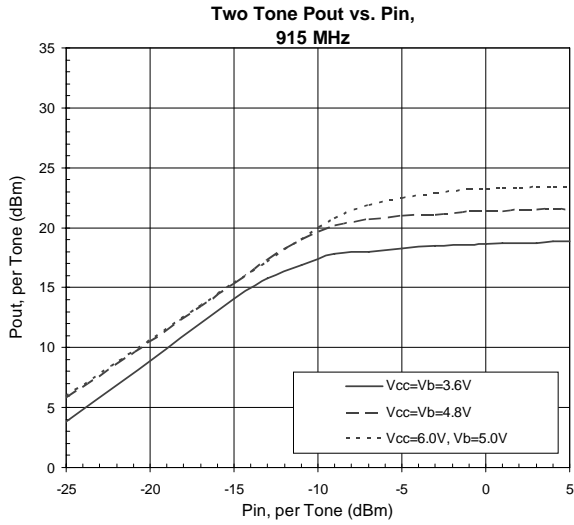

NOT

RF2103P



NOT FOR NEW DESIGNS