

Excellent Integrated System Limited

Stocking Distributor

Click to view price, real time Inventory, Delivery & Lifecycle Information:

[Vishay Semiconductor/Diodes Division](#)
[95HQ015](#)

For any questions, you can email us directly:

sales@integrated-circuit.com

International IOR Rectifier

95HQ015

SCHOTTKY RECTIFIER

95 Amp

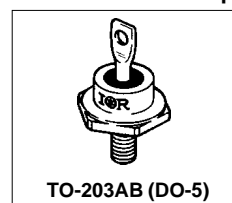

TO-203AB (DO-5)

Major Ratings and Characteristics

Characteristics	95HQ015	Units
$I_{F(AV)}$ Rectangular waveform	95	A
V_{RRM}	15	V
I_{FSM} @ $t_p = 5 \mu s$ sine	7500	A
V_F @ 95 Apk, $T_J = 75^\circ C$	0.39	V
T_J range	-65 to 100	$^\circ C$

Description/ Features

The 95HQ015 Schottky rectifier has been optimized for ultra low forward voltage drop specifically for the OR-ing of parallel power supplies. The proprietary barrier technology allows for reliable operation up to $100^\circ C$ junction temperature. Typical applications are in parallel switching power supplies, converters, reverse battery protection, and redundant power subsystems.

- $100^\circ C$ T_J operation
- Optimized for OR-ing applications
- Ultra low forward voltage drop
- High frequency operation
- Guard ring for enhanced ruggedness and long term reliability
- Hermetic package

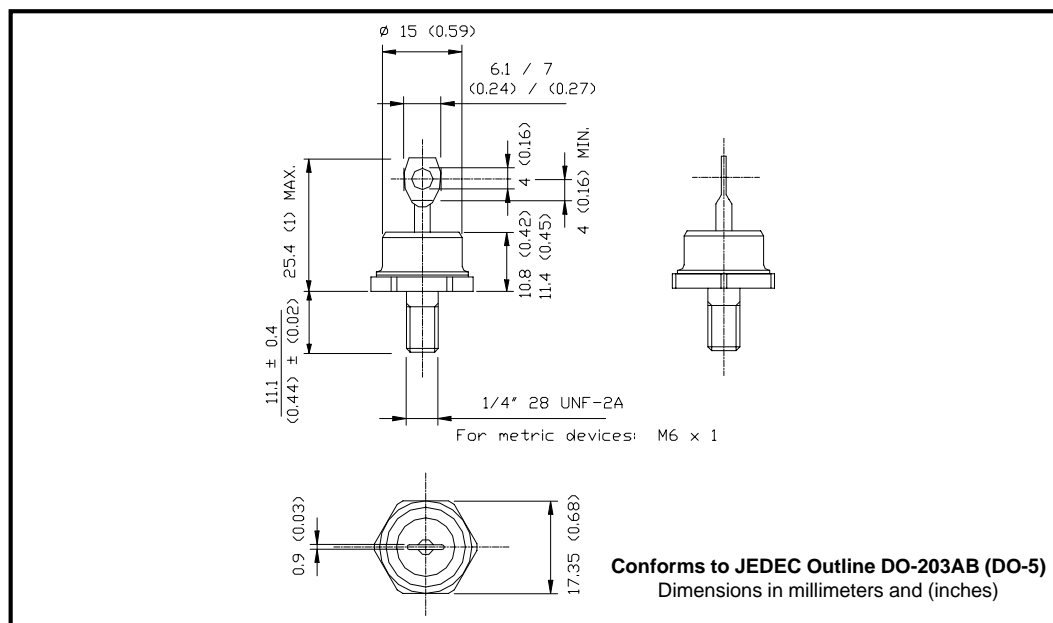

95HQ015

Bulletin PD-2.272 rev. B 11/02

 International

Voltage Ratings

Part number	95HQ015
V_R Max. DC Reverse Voltage (V)	15
V_{RWM} Max. Working Peak Reverse Voltage (V)	25

Absolute Maximum Ratings

Parameters	95HQ	Units	Conditions
$I_{F(AV)}$ Max. Average Forward Current * See Fig. 5	95	A	50% duty cycle @ $T_C = 44^\circ\text{C}$, rectangular wave form
I_{FSM} Max. Peak One Cycle Non-Repetitive Surge Current * See Fig. 7	7500	A	Following any rated load condition and with rated V_{RRM} applied
	1200		
E_{AS} Non-Repetitive Avalanche Energy	9	mJ	$T_J = 25^\circ\text{C}$, $I_{AS} = 2$ Amps, $L = 4.5$ mH
I_{AR} Repetitive Avalanche Current	2	A	Current decaying linearly to zero in 1 μsec Frequency limited by T_J max. $V_A = 3 \times V_R$ typical

Electrical Specifications

Parameters	95HQ	Units	Conditions
V_{FM} Max. Forward Voltage Drop (1) * See Fig. 1	0.46	V	@ 95A $T_J = 25^\circ\text{C}$
	0.62	V	@ 190A
	0.39	V	@ 95A $T_J = 75^\circ\text{C}$
	0.55	V	@ 190A
I_{RM} Max. Reverse Leakage Current (1) * See Fig. 2	20	mA	$T_J = 25^\circ\text{C}$ $V_R = \text{rated } V_R$
	1000	mA	$T_J = 100^\circ\text{C}$
	890	mA	$T_J = 100^\circ\text{C}$ $V_R = 12\text{V}$
	540	mA	$T_J = 100^\circ\text{C}$ $V_R = 5\text{V}$
C_T Max. Junction Capacitance	3600	pF	$V_R = 5V_{DC}$, (test signal range 100Khz to 1Mhz) 25°C
L_S Typical Series Inductance	7.5	nH	Measured from top of terminal to mounting plane
dv/dt Max. Voltage Rate of Change (Rated V_R)	10000	V/ μs	

 (1) Pulse Width < 300 μs , Duty Cycle < 2%

Thermal-Mechanical Specifications

Parameters	95HQ	Units	Conditions
T_J Max. Junction Temperature Range	-65 to 100	$^\circ\text{C}$	
T_{stg} Max. Storage Temperature Range	-65 to 100	$^\circ\text{C}$	
R_{thJC} Max. Thermal Resistance Junction to Case	0.83	$^\circ\text{C/W}$	DC operation * See Fig. 4
R_{thCS} Typical Thermal Resistance, Case to Heatsink	0.25	$^\circ\text{C/W}$	Mounting surface, smooth and greased
wt Approximate Weight	15 (0.53)	g (oz.)	
T Mounting Torque	Min.	23 (20)	Non-lubricated threads
	Max.	46 (40)	
Case Style	DO-203AB(DO-5)	JEDEC	

International
IOR Rectifier

95HQ... Series

Bulletin PD-2.272 rev. B 11/02

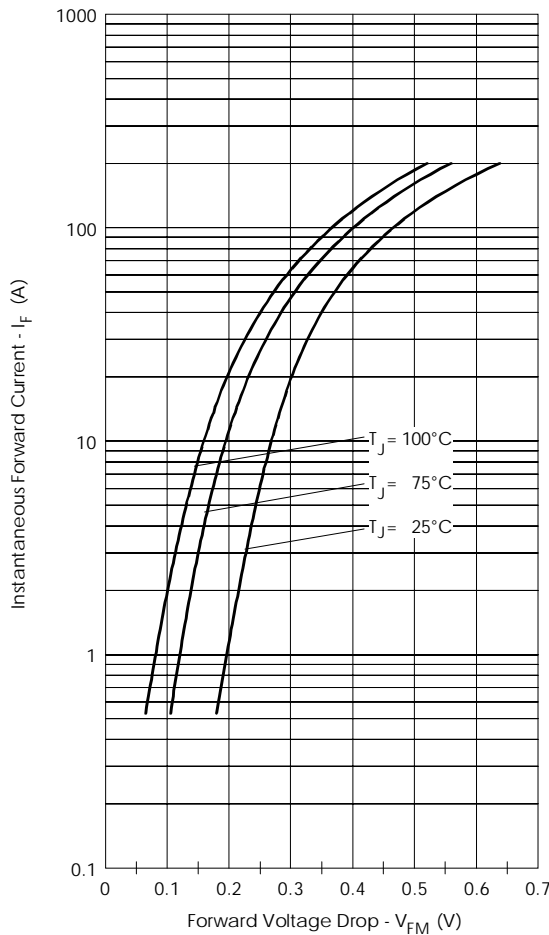

Fig. 1 - Maximum Forward Voltage Drop Characteristics

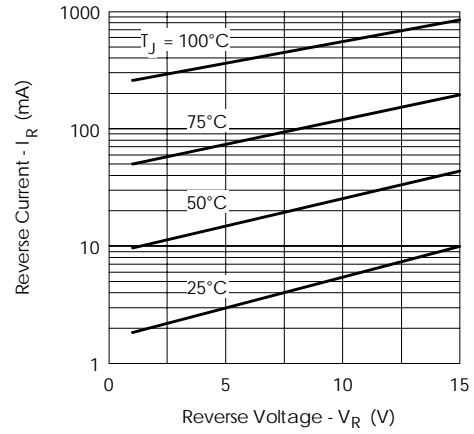

Fig. 2 - Typical Values of Reverse Current Vs. Reverse Voltage

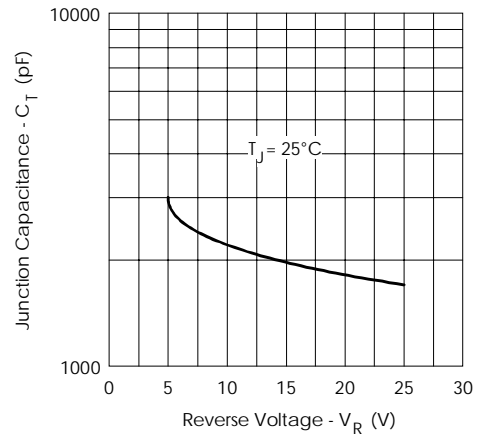

Fig. 3 - Typical Junction Capacitance Vs. Reverse Voltage

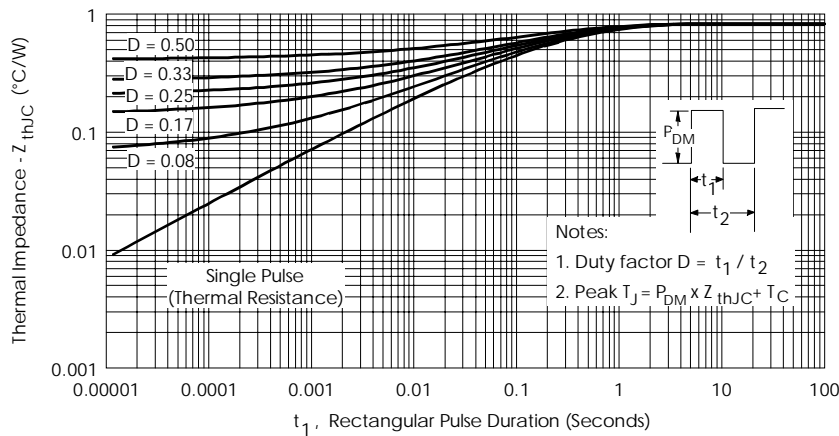

Fig. 4 - Maximum Thermal Impedance Z_{thJC} Characteristics

95HQ015

Bulletin PD-2.272 rev. B 11/02

International
IRF Rectifier

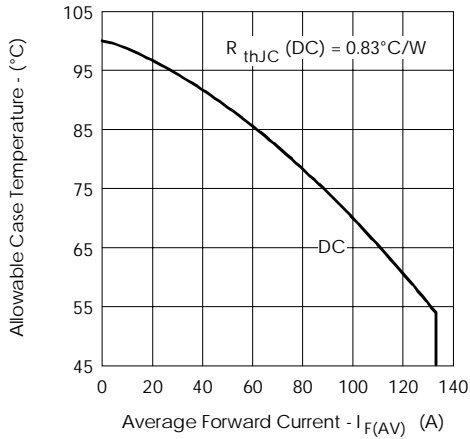

Fig. 5 - Maximum Allowable Case Temperature Vs. Average Forward Current

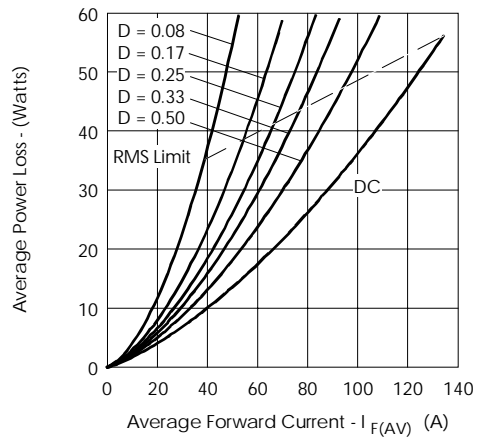

Fig. 6 - Forward Power Loss Characteristics

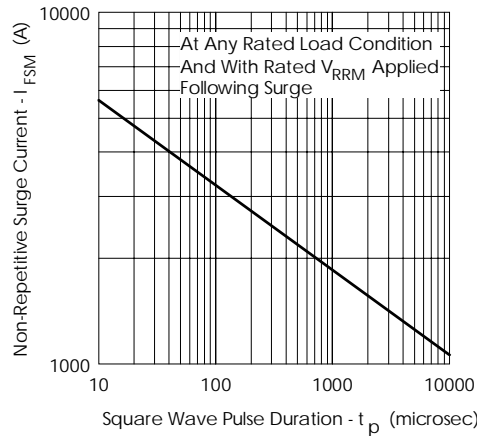

Fig. 7 - Maximum Non-Repetitive Surge Current

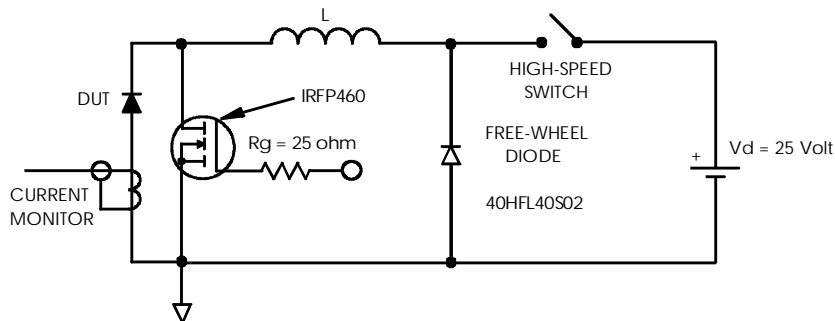

Fig. 8 - Unclamped Inductive Test Circuit

International
IR Rectifier

95HQ... Series

Bulletin PD-2.272 rev. B 11/02

Data and specifications subject to change without notice.
This product has been designed for Industrial Level.
Qualification Standards can be found on IR's Web site.

International
IR Rectifier

IR WORLD HEADQUARTERS: 233 Kansas St., El Segundo, California 90245, USA Tel: (310) 252-7105
TAC Fax: (310) 252-7309
Visit us at www.irf.com for sales contact information. 11/02